

150mA, Low-Dropout Linear Regulator with Power-OK Output

General Description

The MAX8875 low-dropout linear regulator operates from a +2.5V to +6.5V input range and delivers up to 150mA. A P-channel MOSFET pass transistor allows its 85 μ A supply current to remain independent of the load, making this device ideal for battery-operated portable equipment such as PCS phones, cellular phones, cordless phones, and modems.

The MAX8875 features a power-OK (POK) output that indicates when the output is out of regulation. The device is available in several preset output voltage versions: 5.0V, 3.3V, 3.0V, 2.7V, 2.5V, or 1.5V. Other features include 1 μ A (max) shutdown current, short-circuit protection, thermal shutdown protection, and reverse-battery protection. The device comes in a miniature 5-pin SOT23 package.

The MAX8875 is optimized for use with a 1 μ F ceramic output capacitor. For a pin-compatible, functionally equivalent device for use with a higher ESR output capacitor, see the MAX8885 data sheet.

Applications

| | |
|---------------------|-----------------------|
| PCS Telephones | Hand-Held Instruments |
| Cellular Telephones | Palmtop Computers |
| Cordless Telephones | Electronic Planners |
| PCMCIA Cards | Modems |

Typical Operating Circuit

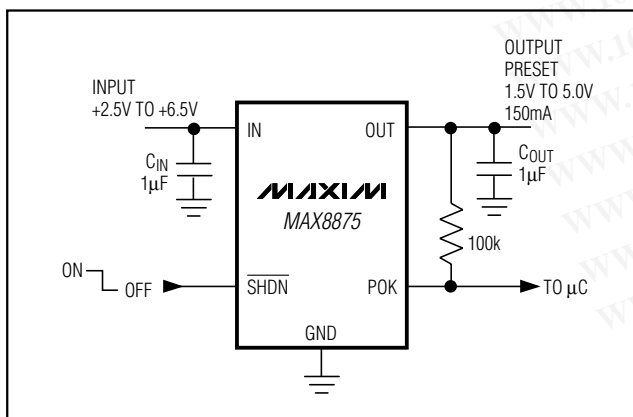

Features

- ◆ Power-OK Output
- ◆ Small Output Capacitor (1 μ F ceramic)
- ◆ Preset Output Voltages (\pm 1% accuracy)
- ◆ Guaranteed 150mA Output Current
- ◆ 85 μ A No-Load Supply Current
- ◆ Low 110mV Dropout at 100mA Load (165mV at 150mA load)
- ◆ Thermal-Overload and Short-Circuit Protection
- ◆ Reverse-Battery Protection
- ◆ 60dB PSRR at 100Hz
- ◆ 1 μ A max Shutdown Current

Ordering Information

| PART* | TEMP. RANGE | PIN-PACKAGE |
|----------------|----------------|-------------|
| MAX8875EUKxy-T | -40°C to +85°C | 5 SOT23-5 |

*xy is the output voltage code (see Output Voltage Selector Guide).

Output Voltage Selector Guide

| PART | V _{OUT} (V) | TOP MARK |
|----------------|----------------------|----------|
| MAX8875EUK15-T | 1.5 | ADQI |
| MAX8875EUK25-T | 2.5 | ADKZ |
| MAX8875EUK27-T | 2.7 | ADLA |
| MAX8875EUK30-T | 3.0 | ADLB |
| MAX8875EUK33-T | 3.3 | ADLC |
| MAX8875EUK50-T | 5.0 | ADLD |

Note: Other output voltages between 1.5V and 5.0V are available in 100mV increments—contact the factory for information. Minimum order quantity is 25,000 units.

Pin Configuration

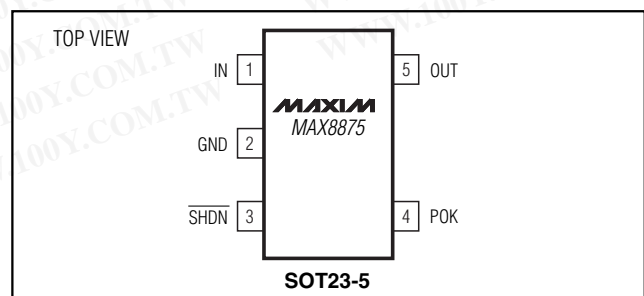

MAX8875

150mA, Low-Dropout Linear Regulator with Power-OK Output

ABSOLUTE MAXIMUM RATINGS

IN, $\overline{\text{SHDN}}$, POK to GND -7V to +7V
 $\overline{\text{SHDN}}$ to IN -7V to +0.3V
 OUT to GND -0.3V to ($V_{\text{IN}} + 0.3\text{V}$)
 Output Short-Circuit Duration Indefinite
 Continuous Power Dissipation ($T_A = +70^\circ\text{C}$)
 5-Pin SOT23 (derate 7.1mW/ $^\circ\text{C}$ above +70 $^\circ\text{C}$) 571mW

Operating Temperature Range -40 $^\circ\text{C}$ to +85 $^\circ\text{C}$
 Junction Temperature +150 $^\circ\text{C}$
 θ_{JA} +140 $^\circ\text{C}/\text{W}$
 Storage Temperature Range -65 $^\circ\text{C}$ to +150 $^\circ\text{C}$
 Lead Temperature (soldering, 10s) +300 $^\circ\text{C}$

Stresses beyond those listed under "Absolute Maximum Ratings" may cause permanent damage to the device. These are stress ratings only, and functional operation of the device at these or any other conditions beyond those indicated in the operational sections of the specifications is not implied. Exposure to absolute maximum rating conditions for extended periods may affect device reliability.

ELECTRICAL CHARACTERISTICS

($V_{\text{IN}} = V_{\text{OUT(NOMINAL)}} + 1\text{V}$, $\overline{\text{SHDN}} = \text{IN}$, $T_A = -40^\circ\text{C}$ to +85 $^\circ\text{C}$, unless otherwise noted. Typical values are at $T_A = +25^\circ\text{C}$.) (Note 1)

| PARAMETER | SYMBOL | CONDITIONS | MIN | TYP | MAX | UNITS |
|--|----------------------------------|--|---------------------------|-------|------|------------------|
| Input Voltage | V_{IN} | | 2.5 | | 6.5 | V |
| Output Voltage Accuracy | | $T_A = +25^\circ\text{C}$, $I_{\text{OUT}} = 100\mu\text{A}$ | -1.0 | | 1.0 | % |
| | | $T_A = -40^\circ\text{C}$ to +85 $^\circ\text{C}$ | | | | |
| | | $I_{\text{OUT}} = 100\mu\text{A}$ | -2 | | 2 | |
| | | $I_{\text{OUT}} = 100\mu\text{A}$ to 120mA | -3 | | 2 | |
| Maximum Output Current | I_{OUT} | | 150 | | | mA |
| Current Limit | I_{LIM} | | 160 | 390 | | mA |
| Ground Pin Current | I_{Q} | $I_{\text{OUT}} = 100\mu\text{A}$ | | 85 | 180 | μA |
| | | $I_{\text{OUT}} = 150\text{mA}$ | | 100 | | |
| Dropout Voltage (Note 2) | $V_{\text{IN}} - V_{\text{OUT}}$ | $I_{\text{OUT}} = 100\mu\text{A}$ | | 0.1 | | mV |
| | | $I_{\text{OUT}} = 50\text{mA}$ | | 50 | | |
| | | $I_{\text{OUT}} = 100\text{mA}$ | | 110 | 220 | |
| | | $I_{\text{OUT}} = 150\text{mA}$ | | 165 | | |
| Line Regulation | ΔV_{LNR} | $V_{\text{IN}} = 2.5\text{V}$ or ($V_{\text{OUT}} + 0.1\text{V}$) to 6.5V, $I_{\text{OUT}} = 1\text{mA}$ | -0.15 | 0 | 0.15 | %/V |
| Load Regulation | ΔV_{LDR} | $I_{\text{OUT}} = 100\mu\text{A}$ to 120mA, $C_{\text{OUT}} = 1\mu\text{F}$ | | 0.01 | | %/mA |
| Output Voltage Noise | | $C_{\text{OUT}} = 10\mu\text{F}$, $f = 10\text{Hz}$ to 100kHz | | 170 | | μVRMS |
| Output Voltage AC Power-Supply Rejection Ratio | PSRR | $f = 100\text{Hz}$ | | 60 | | dB |
| SHUTDOWN | | | | | | |
| Shutdown Supply Current | I_{OFF} | $\overline{\text{SHDN}} = \text{GND}$ | $T_A = +25^\circ\text{C}$ | 0.005 | 1 | μA |
| | | | $T_A = +85^\circ\text{C}$ | 0.02 | | |
| $\overline{\text{SHDN}}$ Input Threshold | V_{IH} | $V_{\text{IN}} = 2.5\text{V}$ to 5.5V | | 2.0 | | V |
| | V_{IL} | | | | 0.4 | |
| $\overline{\text{SHDN}}$ Input Bias Current | $I_{\overline{\text{SHDN}}}$ | $\overline{\text{SHDN}} = \text{IN}$ or GND | $T_A = +25^\circ\text{C}$ | 0 | 100 | nA |
| | | | $T_A = +85^\circ\text{C}$ | 0.05 | | |

150mA, Low-Dropout Linear Regulator with Power-OK Output

MAX8875

ELECTRICAL CHARACTERISTICS (continued)

($V_{IN} = V_{OUT(NOMINAL)} + 1V$, $\overline{SHDN} = IN$, $T_A = -40^{\circ}C$ to $+85^{\circ}C$, unless otherwise noted. Typical values are at $T_A = +25^{\circ}C$.) (Note 1)

| PARAMETER | SYMBOL | CONDITIONS | MIN | TYP | MAX | UNITS | |
|------------------------------|-------------------|---|--------------------------------------|------|-------|-------------|-------|
| POWER-OK OUTPUT | | | | | | | |
| Power-OK Voltage Threshold | V_{POK} | 1 - $V_{OUT}/V_{OUT(NOMINAL)}$ 100, $I_{OUT} = 0$, V_{OUT} falling, $V_{OUT} \geq 2.5V$ | -3 | -5 | -8 | % | |
| | | 1 - $V_{OUT}/V_{OUT(NOMINAL)}$ 100, $I_{OUT} = I_{LIM}$, V_{OUT} falling, $V_{OUT} < 2.5V$ | $T_A = 0^{\circ}C$ to $+85^{\circ}C$ | -8.5 | -10.5 | | -13.5 |
| | | $T_A = -40^{\circ}C$ to $+85^{\circ}C$ | -7 | | -15 | | |
| | | In dropout, V_{OUT} falling, $V_{OUT} \geq 2.5V$ | | -5.3 | | | |
| | | Hysteresis, $I_{OUT} = 0$ | | 1 | | | |
| POK Output Voltage Low | V_{OL} | $I_{SINK} = 1mA$ | | | 0.4 | V | |
| POK Output Leakage Current | | $0 \leq V_{POK} \leq 6.5V$, V_{OUT} in regulation | | | 1 | μA | |
| THERMAL PROTECTION | | | | | | | |
| Thermal Shutdown Temperature | T_{SHDN} | | | 170 | | $^{\circ}C$ | |
| Thermal Shutdown Hysteresis | ΔT_{SHDN} | | | 20 | | $^{\circ}C$ | |

Note 1: Limits are 100% production tested at $T_A = +25^{\circ}C$. Limits over the operating temperature range are guaranteed through correlation using Statistical Quality Control (SQC) methods.

Note 2: Dropout voltage is defined as $V_{IN} - V_{OUT}$, when V_{OUT} is 100mV below the value of V_{OUT} for $V_{IN} = V_{OUT} + 0.5V$. Applies only for output voltages $\geq 2.5V$.

Typical Operating Characteristics

(MAX8875EUK30, $V_{IN} = +3.6V$, $C_{IN} = C_{OUT} = 1\mu F$, $\overline{SHDN} = IN$, $T_A = +25^{\circ}C$, unless otherwise noted.)

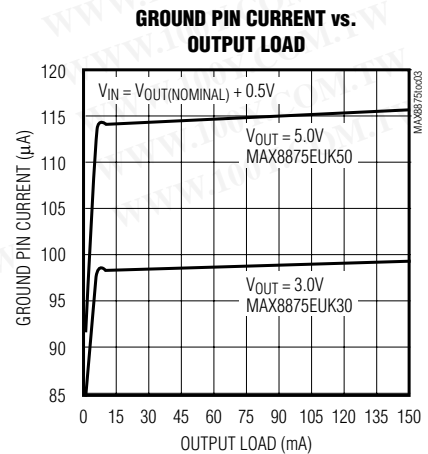
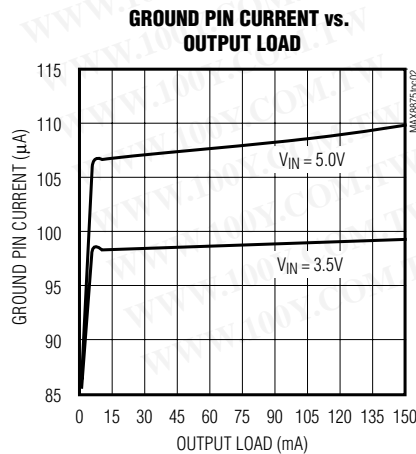
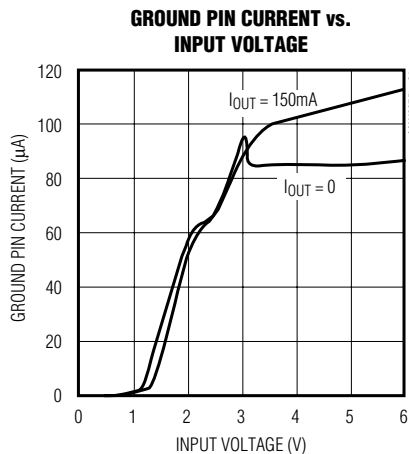

150mA, Low-Dropout Linear Regulator with Power-OK Output

Typical Operating Characteristics (continued)

(MAX8875EUK30, $V_{IN} = +3.6V$, $C_{IN} = C_{OUT} = 1\mu F$, $\overline{SHDN} = IN$, $T_A = +25^\circ C$, unless otherwise noted.)

MAX8875

GROUND PIN CURRENT vs. TEMPERATURE

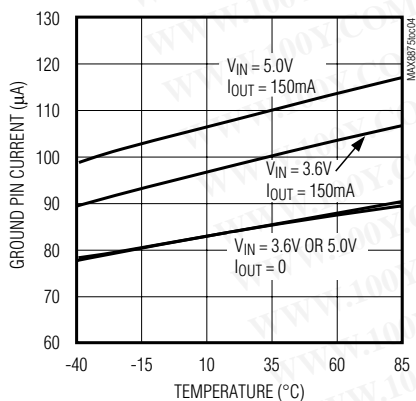

OUTPUT VOLTAGE vs. INPUT VOLTAGE

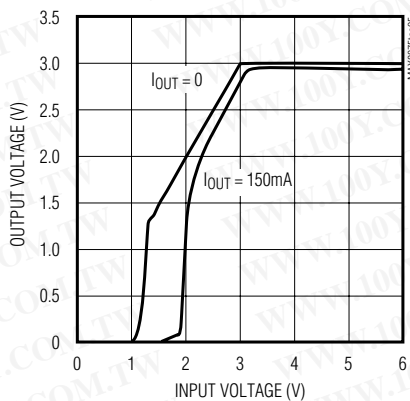

OUTPUT VOLTAGE vs. OUTPUT LOAD

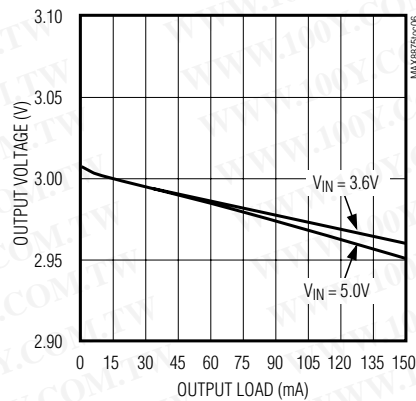

OUTPUT VOLTAGE vs. TEMPERATURE

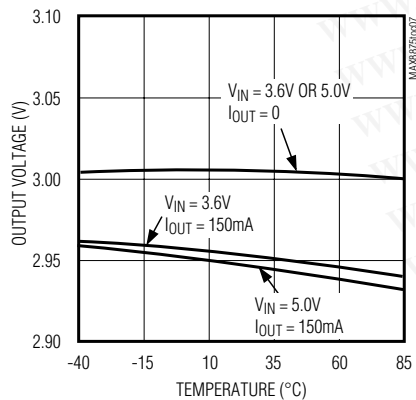

DROPOUT VOLTAGE vs. OUTPUT LOAD

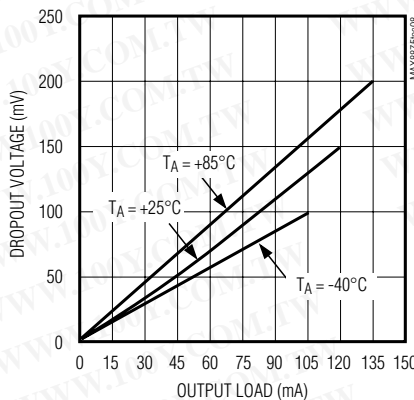

POWER-SUPPLY REJECTION RATIO vs. FREQUENCY

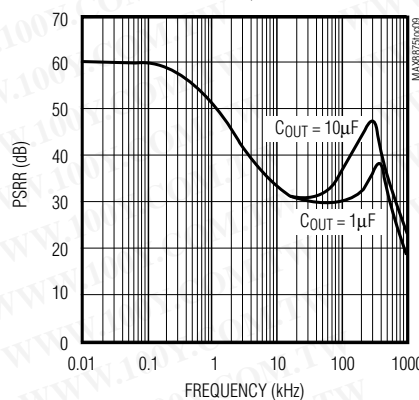

OUTPUT NOISE SPECTRAL DENSITY vs. FREQUENCY

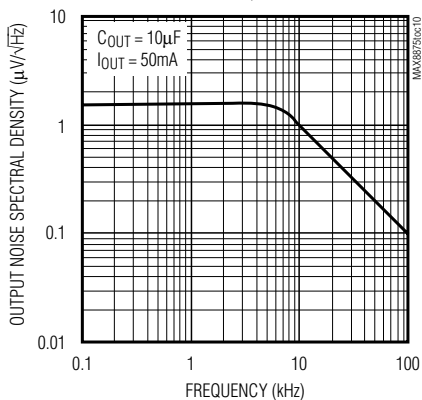

OUTPUT NOISE

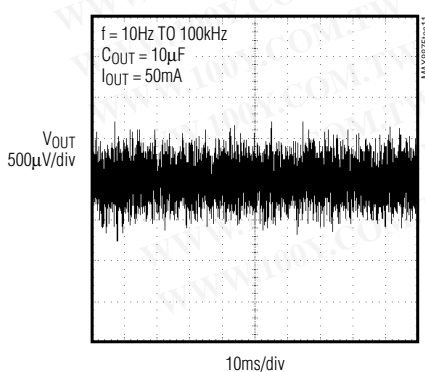

LINE-TRANSIENT RESPONSE

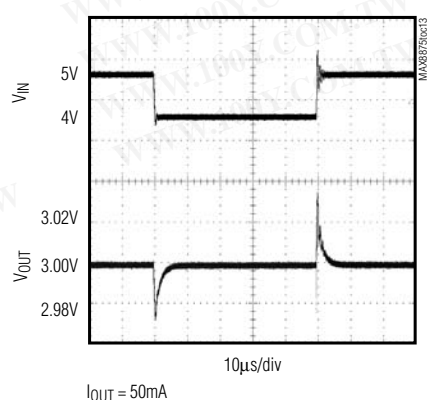

150mA, Low-Dropout Linear Regulator with Power-OK Output

Typical Operating Characteristics (continued)

(MAX8875EUK30, $V_{IN} = +3.6V$, $C_{IN} = C_{OUT} = 1\mu F$, $\overline{SHDN} = IN$, $T_A = +25^\circ C$, unless otherwise noted.)

MAX8875

LOAD-TRANSIENT RESPONSE

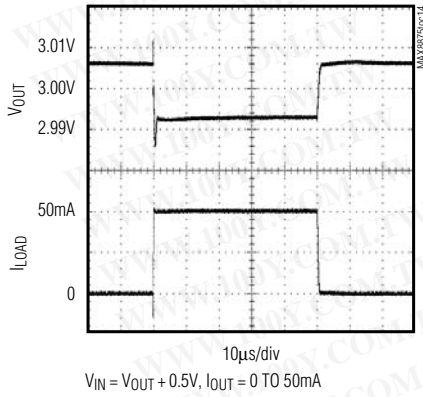

LOAD-TRANSIENT RESPONSE NEAR DROPOUT

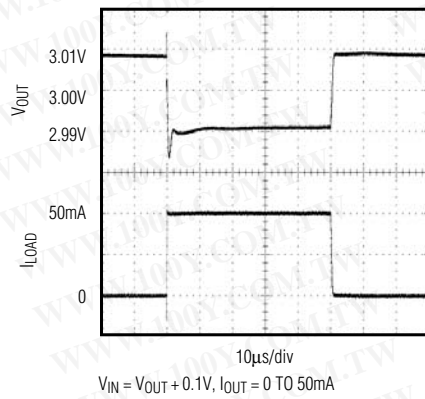

SHUTDOWN DELAY

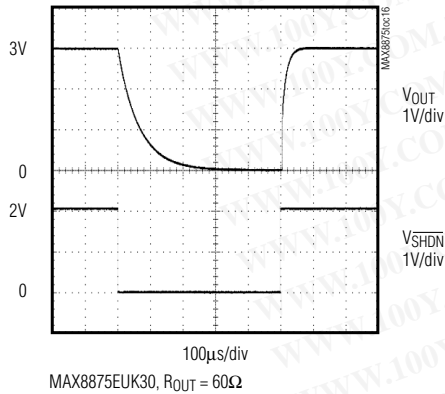

POK OUTPUT

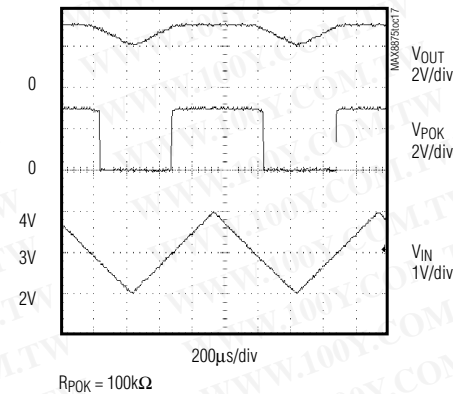

POK STARTUP RESPONSE

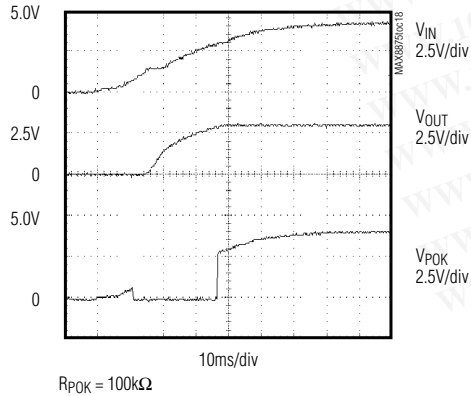

POK AND SHUTDOWN RESPONSE

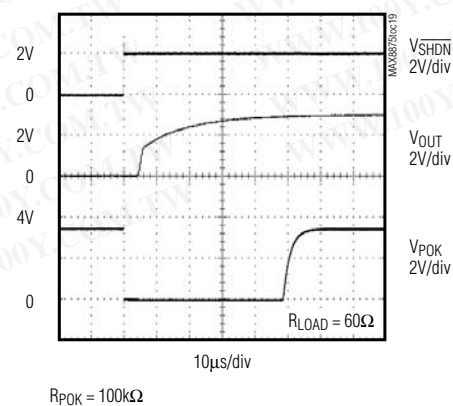

150mA, Low-Dropout Linear Regulator with Power-OK Output

MAX8875

Pin Description

| PIN | NAME | FUNCTION |
|-----|------|---|
| 1 | IN | Regulator Input. Supply voltage can range from 2.5V to 6.5V. Bypass with 1 μ F to GND (see the <i>Capacitor Selection and Regulator Stability</i> section). |
| 2 | GND | Ground. This pin also functions as a heatsink. Solder to a large pad or the circuit-board ground plane to maximize power dissipation. |
| 3 | SHDN | Active-Low Shutdown Input. A logic low reduces the supply current to below 1 μ A. Connect to IN for normal operation. |
| 4 | POK | Power-OK Output. Active-low, open-drain output indicates an out-of-regulation condition. Connect a 100k pull-up resistor to OUT for logic levels. If not used, leave this pin unconnected. |
| 5 | OUT | Regulator Output. Fixed 5.0V, 3.3V, 3.0V, 2.7V, 2.5V, or 1.5V output. Sources up to 150mA. Bypass with 1 μ F (<0.2 Ω typical ESR) ceramic capacitor to GND for $V_{OUT} \geq 2.5V$. Bypass with 3.3 μ F (<0.2 Ω typ ESR) ceramic capacitor to GND for $V_{OUT} = 1.5V$. |

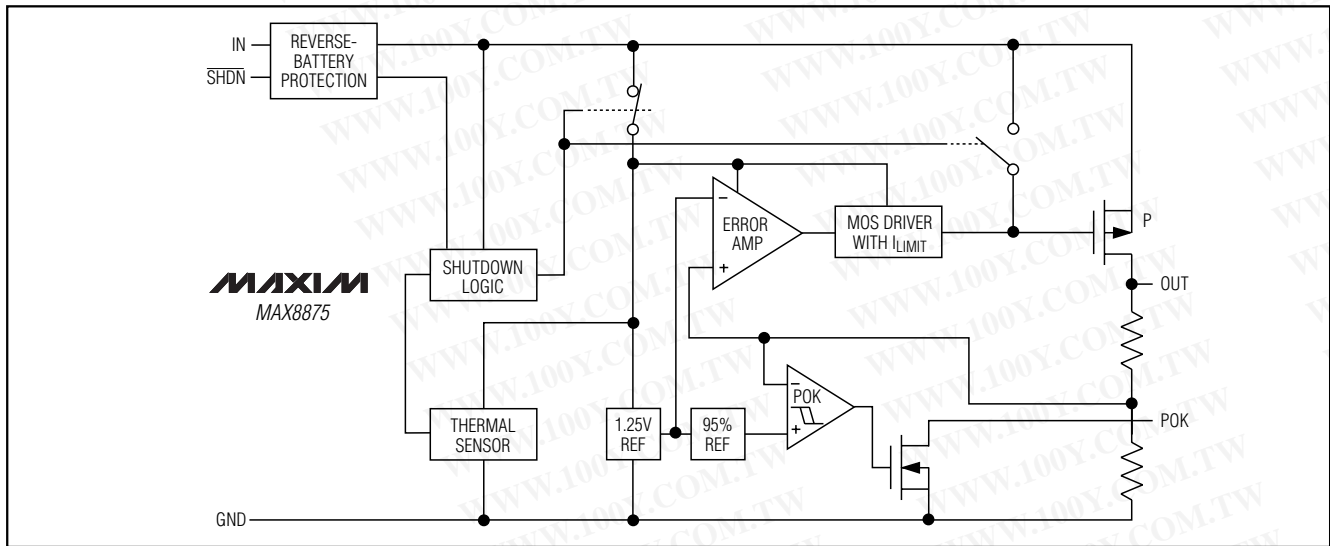

Figure 1. Functional Diagram

Detailed Description

The MAX8875 is a low-dropout, low-quiescent-current linear regulator designed primarily for battery-powered applications. The device supplies loads up to 150mA and is available with preset output voltages of 1.5V, 2.5V, 2.7V, 3.0V, 3.3V, or 5.0V. As illustrated in Figure 1, the MAX8875 consists of a 1.25V reference, error amplifier, P-channel pass transistor, power-OK comparator, and internal feedback voltage divider.

The 1.25V bandgap reference is connected to the error amplifier's inverting input. The error amplifier compares

this reference with the feedback voltage and amplifies the difference. If the feedback voltage is lower than the reference voltage, the pass-transistor gate is pulled lower, which allows more current to pass to the output and increases the output voltage. If the feedback voltage is too high, the pass-transistor gate is pulled up, allowing less current to pass to the output. The output voltage feeds back through an internal resistor voltage divider connected to the OUT pin.

Additional blocks include a current limiter, reverse-battery protection, thermal sensor, and shutdown logic.

150mA, Low-Dropout Linear Regulator with Power-OK Output

MAX8875

Output Voltage

The MAX8875 is supplied with factory-set output voltages of 1.5V, 2.5V, 2.7V, 3.0V, 3.3V, or 5.0V. The part number's two-digit suffix identifies the nominal output voltage. For example, the MAX8875EUK33 has a preset output voltage of 3.3V (see *Output Voltage Selector Guide*).

Internal P-Channel Pass Transistor

The MAX8875 features a 1.1Ω (typ) P-channel MOSFET pass transistor. This provides several advantages over similar designs using PNP pass transistors, including longer battery life. The P-channel MOSFET requires no base drive, which reduces quiescent current significantly. PNP-based regulators waste considerable current in dropout when the pass transistor saturates. They also use high base-drive currents under large loads. The MAX8875 does not suffer from these problems and consumes only 100μA of quiescent current whether in dropout, light-load, or heavy-load applications (see *Typical Operating Characteristics*).

Power-OK Output (POK)

When the output voltage goes out of regulation—as during dropout, current limit, or thermal shutdown—POK goes low. POK is an open-drain N-channel MOSFET. To obtain a logic-level output, connect a pull-up resistor from POK to OUT. To minimize current consumption, make this resistor as large as practical. A 100kΩ resistor works well for most applications. A capacitor to GND may be added to generate a power-on-reset (POR) delay. The POK function is not active during shutdown. POK also provides a power-on-reset function that can operate down to $V_{IN} \leq 1V$. See POK Startup Response in the *Typical Operating Characteristics*.

Current Limit

The MAX8875 includes a current limiter that monitors and controls the pass transistor's gate voltage, limiting the output current to 390mA (typ). For design purposes, consider the current limit to be 160mA min to 600mA max. The output can be shorted to ground for an indefinite period of time without damaging the part.

Thermal-Overload Protection

When the junction temperature exceeds $T_J = +170^\circ\text{C}$, the thermal sensor signals the shutdown logic, turning off the pass transistor and allowing the IC to cool. The thermal sensor will turn the pass transistor on again after the IC's junction temperature cools by 20°C , resulting in a pulsed output during continuous thermal-overload conditions. Thermal-overload protection is designed to protect the MAX8875 in the event of fault conditions. For

continuous operation, do not exceed the absolute maximum junction-temperature rating of $T_J = +150^\circ\text{C}$.

Operating Region and Power Dissipation

The MAX8875's maximum power dissipation depends on the thermal resistance of the case and circuit board, the temperature difference between the die junction and ambient air, and the rate of air flow. The power dissipation across the device is $P = I_{OUT}(V_{IN} - V_{OUT})$. The maximum power dissipation is:

$$P_{MAX} = (T_J - T_A) / (\theta_{JB} + \theta_{BA})$$

where $T_J - T_A$ is the temperature difference between the MAX8875 die junction and the surrounding air, θ_{JB} (or θ_{JC}) is the thermal resistance of the package, and θ_{BA} is the thermal resistance through the printed circuit board, copper traces, and other materials to the surrounding air.

The MAX8875's ground pin (GND) performs the dual function of providing an electrical connection to system ground and channeling heat away. Connect GND to the system ground using a large pad or ground plane.

Reverse-Battery Protection

The MAX8875 has a unique protection scheme that limits the reverse supply current to 1mA when either V_{IN} or V_{SHDN} falls below ground. The circuitry monitors the polarity of these two pins and disconnects the internal circuitry and parasitic diodes when the battery is reversed. This feature prevents device damage.

Applications Information

Capacitor Selection and Regulator Stability

For stable operation over the full temperature range and with load currents up to 150mA, use a 1μF (min) ceramic output capacitor with an ESR $< 0.2\Omega$ for $V_{OUT} \geq 2.5V$, or an equivalent 3.3μF ceramic output capacitor for $V_{OUT} = 1.5V$. To reduce noise and improve load-transient response, stability, and power-supply rejection, use large output capacitor values, such as 10μF.

Note that some ceramic dielectrics exhibit large capacitance and ESR variation with temperature. With dielectrics such as Z5U and Y5V, it may be necessary to increase the capacitance by a factor of 2 or more to ensure stability at temperatures below $T_A = -10^\circ\text{C}$. With X7R or X5R dielectrics, 1μF should be sufficient at all operating temperatures for $V_{OUT} \geq 2.5V$. For a pin-compatible, functionally equivalent device for use with a higher ESR output capacitor, see the MAX8885.

150mA, Low-Dropout Linear Regulator with Power-OK Output

PSRR and Operation from Sources Other than Batteries

The MAX8875 is designed to deliver low dropout voltages and low quiescent currents in battery-powered systems. Power-supply rejection is 60dB at low frequencies. See the Power-Supply Rejection Ratio vs. Frequency graph in the *Typical Operating Characteristics*.

Improve supply-noise rejection and transient response by increasing the values of the input and output bypass capacitors. The *Typical Operating Characteristics* show the MAX8875's line- and load-transient responses.

Dropout Voltage

For versions with the output voltage greater than the minimum input voltage (2.5V), the regulator's minimum input-output voltage differential (or dropout voltage) determines the lowest usable supply voltage. In battery-powered systems, this will determine the useful end-of-life battery voltage. Because the MAX8875 uses a P-channel MOSFET pass transistor, its dropout voltage is a function of drain-to-source on-resistance ($R_{DS(ON)}$) multiplied by the load current (see *Typical Operating Characteristics*):

$$V_{DROPOUT} = V_{IN} - V_{OUT} = R_{DS(ON)} \times I_{OUT}$$

Chip Information

TRANSISTOR COUNT: 266

150mA, Low-Dropout Linear Regulator with Power-OK Output

Package Information

MAX8875

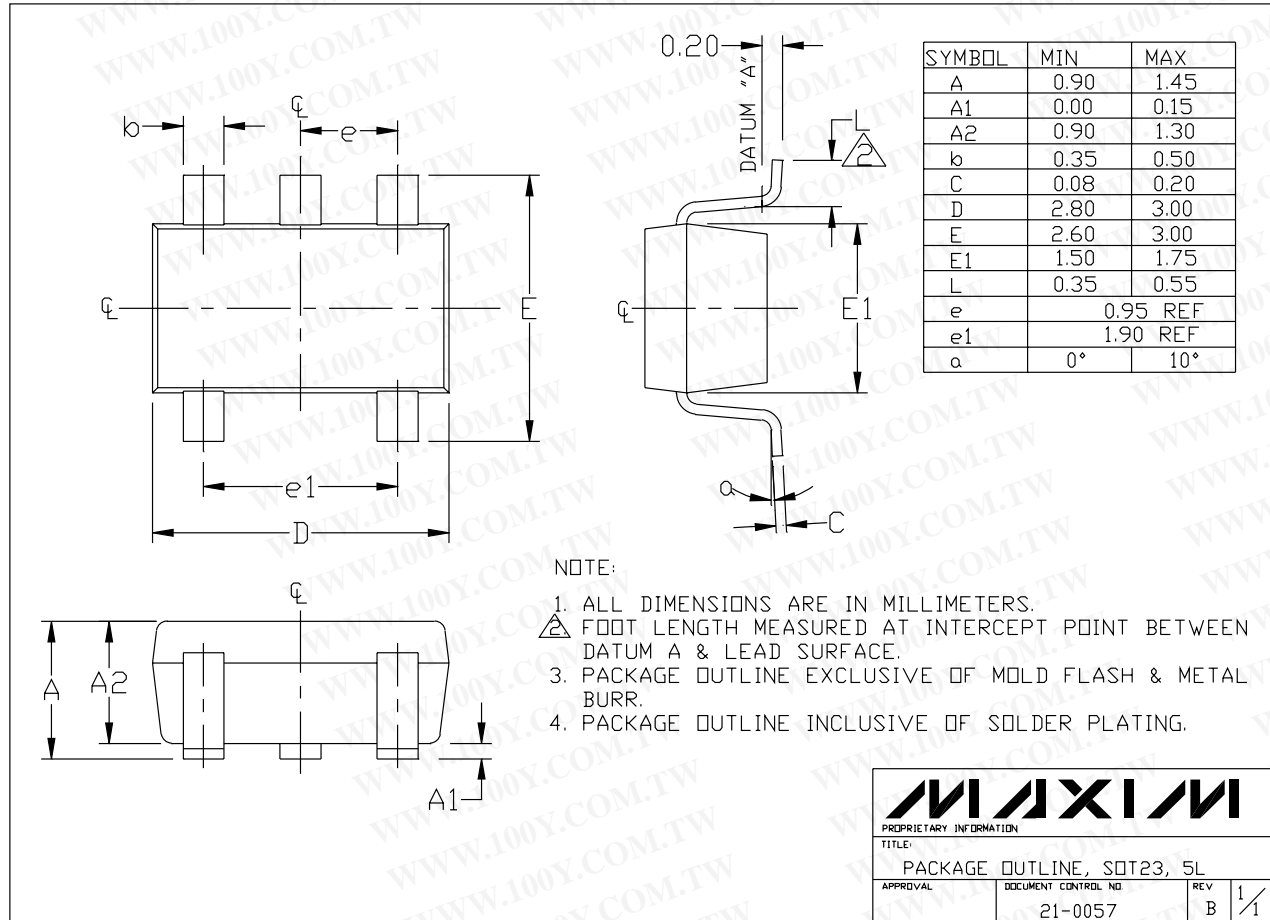

SOT23LEFS

Maxim cannot assume responsibility for use of any circuitry other than circuitry entirely embodied in a Maxim product. No circuit patent licenses are implied. Maxim reserves the right to change the circuitry and specifications without notice at any time.

9 Maxim Integrated Products, 120 San Gabriel Drive, Sunnyvale, CA 94086 408-737-7600