

FEATURES

1. High frequency characteristics

(Impedance 50Ω, ~1.0GHz)

- Insertion loss; Max. 0.3dB
- Isolation; Min. 20dB
(Between open contacts)
Min. 30dB
(Between contact sets)
- V.S.W.R.; Max. 1.2

2. Surface mount terminal

This relay is a surface-mounted model with excellent high-frequency properties. In addition, it can use a microstrip line in the base circuit design which spares the labor of machining the base.

3. Low profile small type

9.7(W)×14.7(L)×5.9(H) mm
.382(W)×.579(L)×.232(H) inch

4. High sensitivity: 140 mW nominal operating power

5. High contact reliability

Electrical life: Min. 10⁷ (10mA 10V DC)

TYPICAL APPLICATIONS

• Measurement instruments

Oscilloscope attenuator circuit

RoHS Directive compatibility information
<http://www.nais-e.com/>

SPECIFICATIONS

Contact		2 Form C	
Arrangement		2 Form C	
Contact material		Gold-clad silver alloy	
Initial contact resistance (By voltage 6V DC 1A)		Max. 75mΩ	
Rating	Contact rating (resistive)	10mA 10 V DC 1A 30 V DC	
	Contact carrying power	Max. 3W (at 1.0GHz, impedance 50Ω, V.S.W.R. max.1.2)	
	Max. switching voltage	30 V DC	
	Max. switching current	1A	
High frequency characteristics (~1GHz, Impedance 50Ω) (Initial)	Isolation	Between open contacts	Min. 20dB
		Between contact sets	Min. 30dB
	Insertion loss	Max. 0.3dB	
	V.S.W.R.	Max. 1.2	
	Input power	Max. 3W (at 1.0GHz, impedance 50Ω, V.S.W.R. max.1.2)	
Nominal operating power	Single side stable	140mW (1.5 to 12V) 200mW (24V) 300mW (48V)	
	1 coil latching	70 mW (1.5 to 12V) 100mW (24V)	
	2 coil latching	140mW (1.5 to 12V) 200mW (24V)	
Expected life (min. operation)	Mechanical (at 180 cpm)		10 ⁸
	Electrical (at 20 cpm)	10mA 10 V DC (resistive load)	10 ⁷
		1A 30 V DC (resistive load)	10 ⁵
Characteristics		Initial insulation resistance *1	
		Min. 100 MΩ (at 500 V DC)	
Initial breakdown voltage *2	Between open contacts		750 Vrms for 1 min.
	Between contact sets		1,000 Vrms for 1 min.
	Between contact and coil		1,000 Vrms for 1 min.
	Between contact and earth terminal		1,000 Vrms for 1 min.
Operate time [Set time] *3 (at 20°C)		Max. 4ms (Approx. 2ms) [Max. 4ms (Approx. 2ms)]	
Release time (without diode) [Reset time] *3 (at 20°C)		Max. 4ms (Approx. 1ms) [Max. 4ms (Approx. 2ms)]	
Temperature rise (at 20°C) *4		Max. 60°C	
Shock resistance	Functional *5	Min. 500 m/s ²	
	Destructive *6	Min. 1,000 m/s ²	
Vibration resistance	Functional *7	10 to 55 Hz at double amplitude of 3mm	
	Destructive	10 to 55 Hz at double amplitude of 5mm	
Conditions for operation, transport and storage *8 (Not freezing and condensing at low temperature)	Ambient temp	-40°C to +85°C -40°F to +185°F	
	Humidity	5 to 85% R.H.	
Unit weight		Approx. 2g .07oz	
Remarks			
* Specifications will vary with foreign standards certification ratings.			
*1 Measurement at same location as "Initial breakdown voltage" section.			
*2 Detection current: 10mA			
*3 Nominal operating voltage applied to the coil, excluding contact bounce time.			
*4 By resistive method, nominal voltage applied to the coil: 3W contact carrying power: at 1.0GHz, Impedance 50Ω, V.S.W.R. Max.1.2			
*5 Half-wave pulse of sine wave: 11ms, detection time: 10μs.			
*6 Half-wave pulse of sine wave: 6ms			
*7 Detection time: 10μs			
*8 Refer to 6. Conditions for operation, transport and storage conditions in NOTES (Page 27).			

勝特力材料 886-3-5753170
勝特力电子(上海) 86-21-54151736
勝特力电子(深圳) 86-755-83298787
[Http://www.100y.com.tw](http://www.100y.com.tw)

ORDERING INFORMATION

Ex. A RA 2 0 0 A 03

Product name	Contact arrangement	Operating function	Type of operation	Terminal shape	Coil voltage, V DC		Packing style
RA	2: 2 Form C	0: Single side stable 1: 1 coil latching 2: 2 coil latching	0: Standard type (B.B.M)	A: Surface-mount terminal	1H: 1.5 03: 3 4H: 4.5 05: 5 06: 6	09: 9 12: 12 24: 24 48: 48	Nil: Tube packing X: Tape and reel packing (picked from 1/2/3 pin side) Z: Tape and reel packing (picked from 8/9/10 pin side)

Note: Packing style; Nil: Tube packing 40 pcs. in an inner package, 1,000 pcs. in an outer package
Z: Tape and reel packing 500 pcs. in an inner package, 1,000 pcs. in an outer package

TYPES ANE COIL DATA (at 20°C 68°F)

• Single side stable type

Part No.	Nominal voltage, V DC	Pick-up voltage, V DC (max.) (initial)	Drop-out voltage, V DC (min.)(initial)	Coil resistance, Ω (±10%)	Nominal operating current, mA (±10%)	Nominal operating power, mW	Max. allowable voltage, V DC
ARA200A1H(Z)	1.5	1.125	0.15	16	93.8	140	2.25
ARA200A03(Z)	3	2.25	0.3	64.3	46.7	140	4.5
ARA200A4H(Z)	4.5	3.375	0.45	145	31	140	6.75
ARA200A05(Z)	5	3.75	0.5	178	28.1	140	7.5
ARA200A06(Z)	6	4.5	0.6	257	23.3	140	9
ARA200A09(Z)	9	6.75	0.9	579	15.5	140	13.5
ARA200A12(Z)	12	9	1.2	1,028	11.7	140	18
ARA200A24(Z)	24	18	2.4	2,880	8.3	200	36
ARA200A48(Z)	48	36	4.8	7,680	6.3	300	57.6

• 1 coil latching type

Part No.	Nominal voltage, V DC	Set voltage, V DC (max.) (initial)	Reset voltage, V DC (max.) (initial)	Coil resistance, Ω (±10%)	Nominal operating current, mA (±10%)	Nominal operating power, mW	Max. allowable voltage, V DC
ARA210A1H(Z)	1.5	1.125	1.125	32	46.9	70	2.25
ARA210A03(Z)	3	2.25	2.25	128.6	23.3	70	4.5
ARA210A4H(Z)	4.5	3.375	3.375	289.3	15.6	70	6.75
ARA210A05(Z)	5	3.75	3.75	357	14	70	7.5
ARA210A06(Z)	6	4.5	4.5	514	11.7	70	9
ARA210A09(Z)	9	6.75	6.75	1,157	7.8	70	13.5
ARA210A12(Z)	12	9	9	2,057	5.8	70	18
ARA210A24(Z)	24	18	18	5,760	4.2	100	36

• 2 coil latching type

Part No.	Nominal voltage, V DC	Set voltage, V DC (max.) (initial)	Reset voltage, V DC (max.) (initial)	Coil resistance, Ω (±10%)	Nominal operating current, mA (±10%)	Nominal operating power, mW	Max. allowable voltage, V DC
ARA220A1H(Z)	1.5	1.125	1.125	16	93.8	140	2.25
ARA220A03(Z)	3	2.25	2.25	64.3	46.7	140	4.5
ARA220A4H(Z)	4.5	3.375	3.375	145	31	140	6.75
ARA220A05(Z)	5	3.75	3.75	178	28.1	140	7.5
ARA220A06(Z)	6	4.5	4.5	257	23.3	140	9
ARA220A09(Z)	9	6.75	6.75	579	15.5	140	13.5
ARA220A12(Z)	12	9	9	1,028	11.7	140	18
ARA220A24(Z)	24	18	18	2,880	8.3	200	36

勝特力材料 886-3-5753170
 勝特力电子(上海) 86-21-54151736
 勝特力电子(深圳) 86-755-83298787
[Http://www.100y.com.tw](http://www.100y.com.tw)

RA (ARA)

DIMENSIONS

勝特力材料 886-3-5753170
 勝特力电子(上海) 86-21-54151736
 勝特力电子(深圳) 86-755-83298787
[Http://www.100y.com.tw](http://www.100y.com.tw)

mm inch

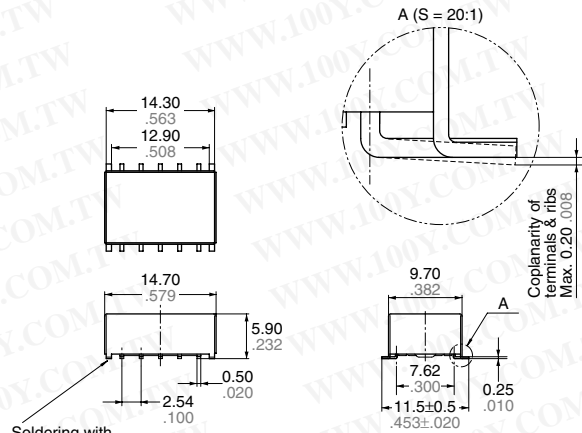

Soldering with PC board earth (4 ribs)

Tolerance: $\pm 0.3 \pm 0.012$

Suggested Mounting Pads (Top view)

Single side stable

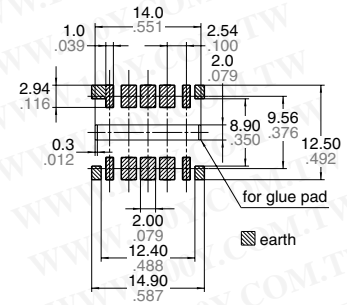

1 coil latching

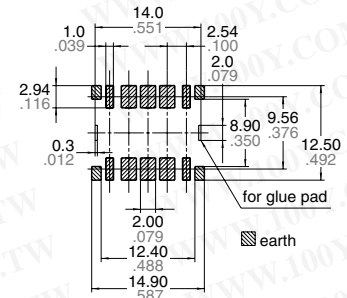

2 coil latching

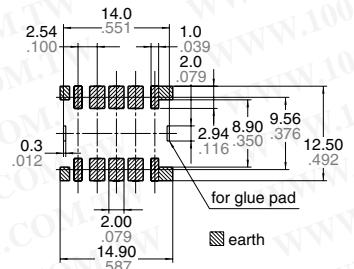

Tolerance: $\pm 0.1 \pm 0.004$

Schematic (Top view)

Single side stable

1 coil latching

2 coil latching

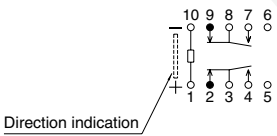

(Deenergized condition)

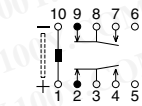

(Reset condition)

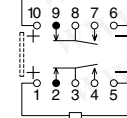

(Reset condition)

REFERENCE DATA

1-(1). High frequency characteristics (Impedance 50Ω)

Sample: ARA200A12

Measuring method: Measured with HP network analyzer (HP8753C).

• V.S.W.R.

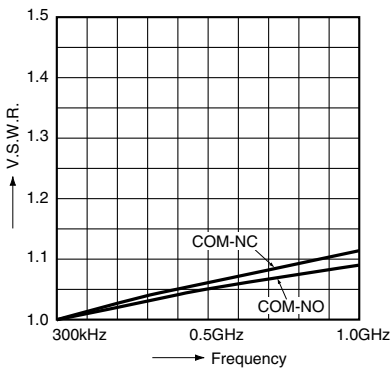

• Insertion loss

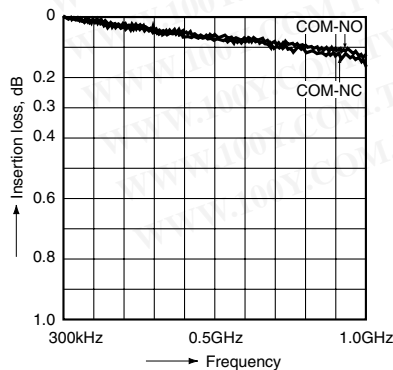

• Isolation

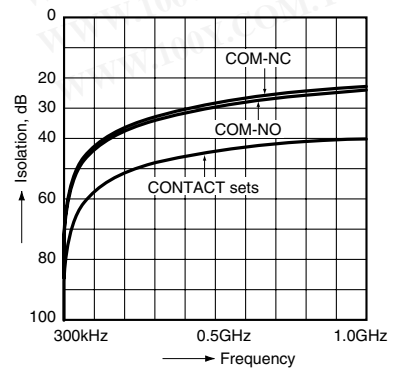

1-(2). High frequency characteristics (Impedance 75Ω)

Sample: ARA200A12

Measuring method: Measured with HP network analyzer (HP8753C).

• V.S.W.R.

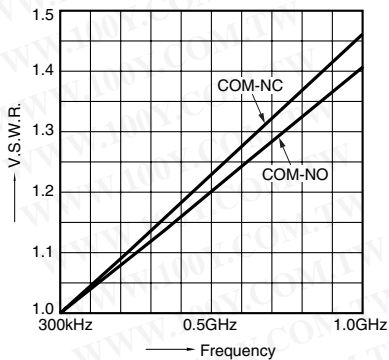

• Insertion loss

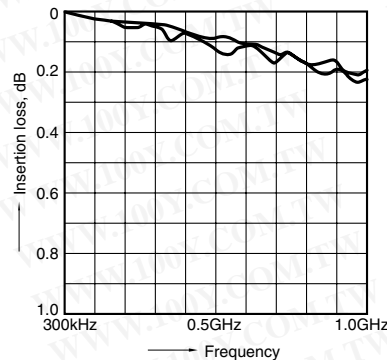

• Isolation

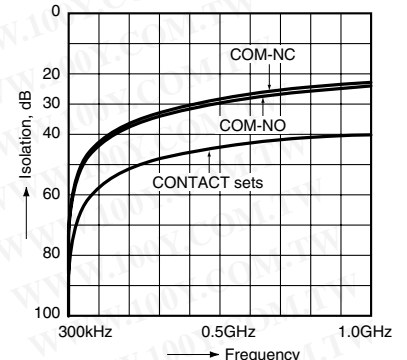

NOTES

1. Coil operating power

Pure DC current should be applied to the coil. The wave form should be rectangular. If it includes ripple, the ripple factor should be less than 5%. However, check it with the actual circuit since the characteristics may be slightly different. The nominal operating voltage should be applied to the coil for more than 10 ms to set/reset the latching type relay.

2. Coil connection

When connecting coils, refer to the wiring diagram to prevent mis-operation or malfunction.

3. External magnetic field

Since RA relays are highly sensitive polarized relays, their characteristics will be affected by a strong external magnetic field. Avoid using the relay under that condition.

4. Cleaning

For automatic cleaning, the boiling method is recommended. Avoid ultrasonic cleaning which subjects the relays to high frequency vibrations, which may cause the contacts to stick. It is recommended that alcoholic solvents be used.

5. Soldering

Manual soldering shall be performed under following condition.
 Tip temperature: 280°C to 300°C 536°F to 572°F.
 Wattage: 30 to 60W
 Soldering time: within 5s
 In case of automatic soldering, the following conditions should be observed

1) Position of measuring temperature

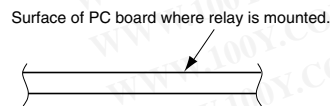

2) IR (infrared reflow) soldering method

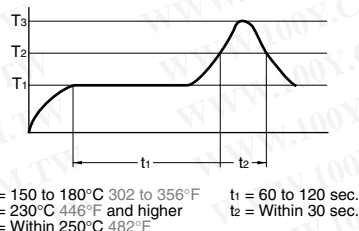

Temperature rise of relay itself may vary according to the mounting level or the heating method of reflow equipment. Therefore, please set the temperature of soldering portion of relay terminal and the top surface of the relay case not to exceed the above mentioned soldering condition.

It is recommended to check the temperature rise of each portion under actual mounting condition before use. The soldering earth shall be performed by manual soldering.

6. Conditions for operation, transport and storage conditions

1) Ambient temperature, humidity, and atmospheric pressure during usage, transport, and storage of the relay:

- (1) Temperature: -40 to +70°C -40 to +158°F
- (2) Humidity: 5 to 85% RH (Avoid freezing and condensation.) The humidity range varies with the temperature. Use within the range indicated in the graph below.

(3) Atmospheric pressure: 86 to 106 kPa
 Temperature and humidity range for usage, transport, and storage:

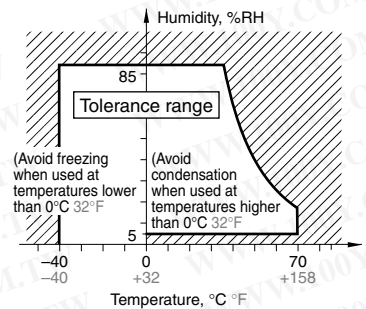

2) Condensation

Condensation forms when there is a sudden change in temperature under high temperature and high humidity conditions. Condensation will cause deterioration of the relay insulation.

3) Freezing

Condensation or other moisture may freeze on the relay when the temperature is lower than 0°C 32°F. This causes problems such as sticking of movable parts or operational time lags.

4) Low temperature, low humidity environments

The plastic becomes brittle if the relay is exposed to a low temperature, low humidity environment for long periods of time.

勝特力材料 886-3-5753170
 胜特力电子(上海) 86-21-54151736
 胜特力电子(深圳) 86-755-83298787
[Http://www.100y.com.tw](http://www.100y.com.tw)