

BIPOLAR ANALOG INTEGRATED CIRCUIT

μ PC78L00 SERIES

THREE TERMINAL POSITIVE VOLTAGE REGULATORS

DESCRIPTION

The μ PC78L00 series are monolithic three terminal positive regulators which employ internally current limiting, thermal shut down, output transistor safe area protection make them essentially indestructible.

They are intended as fixed voltage regulators in a wide range of application including local on card regulation for elimination of distribution problems associated wide single point regulation.

FEATURES

- Output current in excess of 100 mA.
- Low noise.
- High Ripple Rejection.
- Internal output transistor safe area protection.
- Internal thermal overload protection.
- Internal short circuit current limiting.

ORDER INFORMATION

Type Number	Output Voltage	Package	Quality Grade
μ PC78L05J	5 V	TO-92	Standard
μ PC78L05T		SOT-89	
μ PC78L06J	6 V	TO-92	
μ PC78L06T		SOT-89	
μ PC78L07J	7 V	TO-92	
μ PC78L07T		SOT-89	
μ PC78L08J	8 V	TO-92	
μ PC78L08T		SOT-89	
μ PC78L10J	10 V	TO-92	
μ PC78L10T		SOT-89	
μ PC78L12J	12 V	TO-92	
μ PC78L12T		SOT-89	
μ PC78L15J	15 V	TO-92	
μ PC78L15T		SOT-89	

CONNECTION DIAGRAM

μ PC78L00J Series

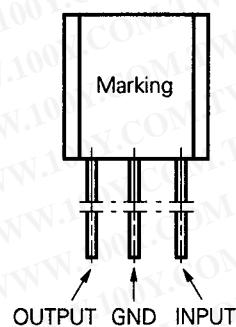

μ PC78L00T Series

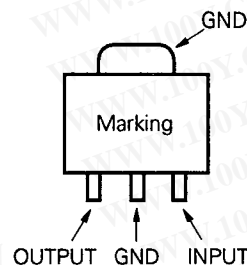

Please refer to "Quality grade on NEC Semiconductor Devices" (Document number IEI-1209) published by NEC Corporation to know the specification of quality grade on the devices and its recommended applications.

勝特力材料 886-3-5753170
 勝特力电子(上海) 86-21-54151736
 勝特力电子(深圳) 86-755-83298787
[Http://www.100y.com.tw](http://www.100y.com.tw)

EQUIVALENT CIRCUIT

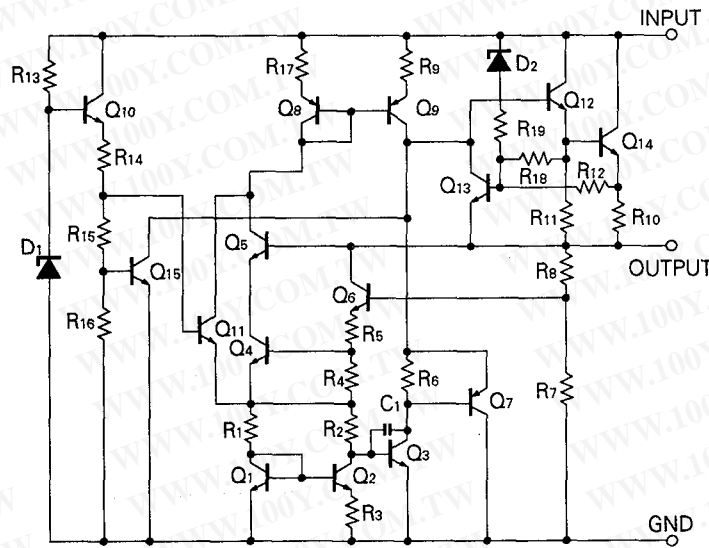

ABSOLUTE MAXIMUM RATINGS (T_a = 25 °C)

PARAMETER	SYMBOL	RATINGS		UNIT
		μPC78L00J Series	μPC78L00T Series	
Input Voltage	V _{IN}	30/35 (Note1)		V
Internal Power Dissipation	P _T	700	400/2000 (Note2)	mW
Operating Ambient Temperature Range	T _{opt}	-20 to +85		°C
Operating Junction Temperature Range	T _{opt(j)}	-20 to +150		°C
Storage Temperature Range	T _{stg}	-55 to +150		°C
Thermal Resistance (junction to ambient)	R _{th(j-a)}	180	315/62.5 (Note2)	°C/W

(Note 1) μPC78L05, 06, 07, 08 : 30 V, μPC78L10, 12, 15 : 35 V

(Note 2) with 2.5 cm² × 0.7 mm ceramic substrate

TYPICAL CONNECTION

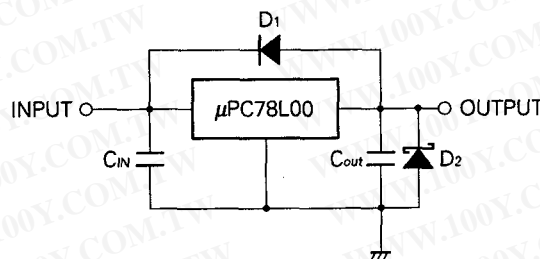

C₁: Required if regulator is located an appreciable distance from power supply filter

C₂: More than 0.1 μF

D₁: Needed for V_{IN} < V_o

D₂: Needed for V_o < GND

勝特力材料 886-3-5753170
 勝特力电子(上海) 86-21-54151736
 勝特力电子(深圳) 86-755-83298787
[Http://www.100y.com.tw](http://www.100y.com.tw)

RECOMMENDED OPERATING CONDITIONS

CHARACTERISTIC	SYMBOL	TYPE NUMBER	MIN.	TYP.	MAX.	UNIT
Input Voltage	V _{IN}	μPC78L05	7	10	20	V
		μPC78L06	8.5	11	21	
		μPC78L07	9.5	12	22	
		μPC78L08	10.5	14	23	
		μPC78L10	12.5	17	25	
		μPC78L12	14.5	19	27	
Output Current	I _o	All	0	40	70	mA
Operating Temperature Range	T _{opt}	All	-20		+85	°C
Operating Junction Temperature Range	T _{opt (j)}	All	-20		+125	°C

ELECTRICAL CHARACTERISTICS μPC78L05

(V_{IN} = 10 V, I_o = 40 mA, 0 °C ≤ T_j ≤ + 125 °C, C_{IN} = 0.33 μF, C_{OUT} = 0.1 μF)

CHARACTERISTIC	SYMBOL	TEST CONDITIONS	MIN.	TYP.	MAX.	UNIT	
Output Voltage	V _o	T _j = 25 °C	4.8	5.0	5.2	V	
		7 V ≤ V _{IN} ≤ 20 V, 1 mA ≤ I _o ≤ 40 mA	4.75		5.25		
		V _{IN} = 10 V, 1 mA ≤ I _o ≤ 70 mA	4.75		5.25		
Line Regulation	REG _{IN}	T _j = 25 °C, 7 V ≤ V _{IN} ≤ 20 V		6	150	mV	
		T _j = 25 °C, 8 V ≤ V _{IN} ≤ 20 V		4	100		
Load Regulation	REG _L	T _j = 25 °C, 1 mA ≤ I _o ≤ 100 mA		9	60	mV	
		T _j = 25 °C, 1 mA ≤ I _o ≤ 40 mA		4	30		
Quiescent Current	I _{BIAS}	T _j = 25 °C		2.3	5.5	mA	
Quiescent Current Change	ΔI _{BIAS}	8 V ≤ V _{IN} ≤ 20 V, I _o = 40 mA			1.5	mA	
		V _{IN} = 10 V, 1 mA ≤ I _o ≤ 40 mA			0.1		
Output Noise Voltage	V _n	T _j = 25 °C, 10 Hz ≤ f ≤ 100 kHz		45	120	μV _{r.m.s.}	
Ripple Rejection	R · R	T _j = 25 °C, f = 120 Hz, 8 V ≤ V _{IN} ≤ 18 V	55	75		dB	
Dropout Voltage	V _{DIF}	T _j = 25 °C		1.7		V	
Short Circuit Current	I _{Oshort}	T _j = 25 °C, V _{IN} = 20 V		88		mA	
Peak Output Current	I _{Opeak}	T _j = 25 °C		125	160	205	mA
Temperature coefficient of Output Voltage	ΔV _o /ΔT	I _o = 5 mA		0.4		mV/°C	

勝特力材料 886-3-5753170
 勝特力电子(上海) 86-21-54151736
 勝特力电子(深圳) 86-755-83298787
[Http://www.100y.com.tw](http://www.100y.com.tw)

ELECTRICAL CHARACTERISTICS μ PC78L06

($V_{IN} = 11\text{ V}$, $I_o = 40\text{ mA}$, $0\text{ }^\circ\text{C} \leq T_j \leq +125\text{ }^\circ\text{C}$, $C_{IN} = 0.33\text{ }\mu\text{F}$, $C_{OUT} = 0.1\text{ }\mu\text{F}$)

CHARACTERISTIC	SYMBOL	TEST CONDITIONS	MIN.	TYP.	MAX.	UNIT
Output Voltage	V_o	$T_j = 25\text{ }^\circ\text{C}$	5.76	6.0	6.24	V
		$8.5\text{ V} \leq V_{IN} \leq 21\text{ V}$, $1\text{ mA} \leq I_o \leq 40\text{ mA}$	5.70		6.30	
		$V_{IN} = 11\text{ V}$, $1\text{ mA} \leq I_o \leq 70\text{ mA}$	5.70		6.30	
Line Regulation	REG _{IN}	$T_j = 25\text{ }^\circ\text{C}$, $8.5\text{ V} \leq V_{IN} \leq 21\text{ V}$		6	155	mV
		$T_j = 25\text{ }^\circ\text{C}$, $9\text{ V} \leq V_{IN} \leq 21\text{ V}$		4	105	
Load Regulation	REG _L	$T_j = 25\text{ }^\circ\text{C}$, $1\text{ mA} \leq I_o \leq 100\text{ mA}$		10	65	mV
		$T_j = 25\text{ }^\circ\text{C}$, $1\text{ mA} \leq I_o \leq 40\text{ mA}$		4	35	
Quiescent Current	I _{BIAS}	$T_j = 25\text{ }^\circ\text{C}$		2.3	5.5	mA
Quiescent Current Change	ΔI_{BIAS}	$9\text{ V} \leq V_{IN} \leq 21\text{ V}$, $I_o = 40\text{ mA}$			1.5	mA
		$V_{IN} = 11\text{ V}$, $1\text{ mA} \leq I_o \leq 40\text{ mA}$			0.1	
Output Noise Voltage	V_n	$T_j = 25\text{ }^\circ\text{C}$, $10\text{ Hz} \leq f \leq 100\text{ kHz}$		55	145	$\mu\text{V}_{r.m.s.}$
Ripple Rejection	R · R	$T_j = 25\text{ }^\circ\text{C}$, $f = 120\text{ Hz}$, $9\text{ V} \leq V_{IN} \leq 19\text{ V}$	54	75		dB
Dropout Voltage	V _{DIF}	$T_j = 25\text{ }^\circ\text{C}$		1.7		V
Short Circuit Current	I _{short}	$T_j = 25\text{ }^\circ\text{C}$, $V_{IN} = 21\text{ V}$		85		mA
Peak Output Current	I _{peak}	$T_j = 25\text{ }^\circ\text{C}$	125	160	205	mA
Temperature coefficient of Output Voltage	$\Delta V_o / \Delta T$	$I_o = 5\text{ mA}$		0.5		mV/°C

ELECTRICAL CHARACTERISTICS μ PC78L07

($V_{IN} = 12\text{ V}$, $I_o = 40\text{ mA}$, $0\text{ }^\circ\text{C} \leq T_j \leq +125\text{ }^\circ\text{C}$, $C_{IN} = 0.33\text{ }\mu\text{F}$, $C_{OUT} = 0.1\text{ }\mu\text{F}$)

CHARACTERISTIC	SYMBOL	TEST CONDITIONS	MIN.	TYP.	MAX.	UNIT
Output Voltage	V_o	$T_j = 25\text{ }^\circ\text{C}$	6.72	7.0	7.28	V
		$9.5\text{ V} \leq V_{IN} \leq 22\text{ V}$, $1\text{ mA} \leq I_o \leq 40\text{ mA}$	6.65		7.35	
		$V_{IN} = 12\text{ V}$, $1\text{ mA} \leq I_o \leq 70\text{ mA}$	6.65		7.35	
Line Regulation	REG _{IN}	$T_j = 25\text{ }^\circ\text{C}$, $9.5\text{ V} \leq V_{IN} \leq 22\text{ V}$		8	165	mV
		$T_j = 25\text{ }^\circ\text{C}$, $10\text{ V} \leq V_{IN} \leq 22\text{ V}$		5	115	
Load Regulation	REG _L	$T_j = 25\text{ }^\circ\text{C}$, $1\text{ mA} \leq I_o \leq 100\text{ mA}$		12	75	mV
		$T_j = 25\text{ }^\circ\text{C}$, $1\text{ mA} \leq I_o \leq 40\text{ mA}$		5	35	
Quiescent Current	I _{BIAS}	$T_j = 25\text{ }^\circ\text{C}$		2.3	5.5	mA
Quiescent Current Change	ΔI_{BIAS}	$10\text{ V} \leq V_{IN} \leq 22\text{ V}$, $I_o = 40\text{ mA}$			1.5	mA
		$V_{IN} = 12\text{ V}$, $1\text{ mA} \leq I_o \leq 40\text{ mA}$			0.1	
Output Noise Voltage	V_n	$T_j = 25\text{ }^\circ\text{C}$, $10\text{ Hz} \leq f \leq 100\text{ kHz}$		70	180	$\mu\text{V}_{r.m.s.}$
Ripple Rejection	R · R	$T_j = 25\text{ }^\circ\text{C}$, $f = 120\text{ Hz}$, $10\text{ V} \leq V_{IN} \leq 20\text{ V}$	52	74		dB
Dropout Voltage	V _{DIF}	$T_j = 25\text{ }^\circ\text{C}$		1.7		V
Short Circuit Current	I _{short}	$T_j = 25\text{ }^\circ\text{C}$, $V_{IN} = 22\text{ V}$		83		mA
Peak Output Current	I _{peak}	$T_j = 25\text{ }^\circ\text{C}$	125	160	205	mA
Temperature coefficient of Output Voltage	$\Delta V_o / \Delta T$	$I_o = 5\text{ mA}$		0.6		mV/°C

勝特力材料 886-3-5753170
 勝特力电子(上海) 86-21-54151736
 勝特力电子(深圳) 86-755-83298787
[Http://www.100y.com.tw](http://www.100y.com.tw)

ELECTRICAL CHARACTERISTICS μPC78L08

($V_{IN} = 14\text{ V}$, $I_o = 40\text{ mA}$, $0\text{ °C} \leq T_j \leq +125\text{ °C}$, $C_{IN} = 0.33\text{ }\mu\text{F}$, $C_{OUT} = 0.1\text{ }\mu\text{F}$)

CHARACTERISTIC	SYMBOL	TEST CONDITIONS	MIN.	TYP.	MAX.	UNIT
Output Voltage	V_o	$T_j = 25\text{ °C}$	7.7	8.0	8.3	V
		$10.5\text{ V} \leq V_{IN} \leq 23\text{ V}$, $1\text{ mA} \leq I_o \leq 40\text{ mA}$	7.6		8.4	
		$V_{IN} = 14\text{ V}$, $1\text{ mA} \leq I_o \leq 70\text{ mA}$	7.6		8.4	
Line Regulation	REG _{IN}	$T_j = 25\text{ °C}$, $10.5\text{ V} \leq V_{IN} \leq 23\text{ V}$		10	175	mV
		$T_j = 25\text{ °C}$, $11\text{ V} \leq V_{IN} \leq 23\text{ V}$		6	125	
Load Regulation	REG _L	$T_j = 25\text{ °C}$, $1\text{ mA} \leq I_o \leq 100\text{ mA}$		14	80	mV
		$T_j = 25\text{ °C}$, $1\text{ mA} \leq I_o \leq 40\text{ mA}$		6	40	
Quiescent Current	I _{BIAS}	$T_j = 25\text{ °C}$		2.4	5.5	mA
Quiescent Current Change	ΔI_{BIAS}	$12\text{ V} \leq V_{IN} \leq 23\text{ V}$, $I_o = 40\text{ mA}$			1.5	mA
		$V_{IN} = 14\text{ V}$, $1\text{ mA} \leq I_o \leq 40\text{ mA}$			0.1	
Output Noise Voltage	V_n	$T_j = 25\text{ °C}$, $10\text{ Hz} \leq f \leq 100\text{ kHz}$		85	190	μV _{r.m.s.}
Ripple Rejection	R · R	$T_j = 25\text{ °C}$, $f = 120\text{ Hz}$, $12\text{ V} \leq V_{IN} \leq 22\text{ V}$	51	73		dB
Dropout Voltage	V _{DIF}	$T_j = 25\text{ °C}$		1.7		V
Short Circuit Current	I _{oshort}	$T_j = 25\text{ °C}$, $V_{IN} = 23\text{ V}$		80		mA
Peak Output Current	I _{Opeak}	$T_j = 25\text{ °C}$	125	160	205	mA
Temperature coefficient of Output Voltage	$\Delta V_o / \Delta T$	$I_o = 5\text{ mA}$		0.6		mV/°C

ELECTRICAL CHARACTERISTICS μPC78L10

($V_{IN} = 17\text{ V}$, $I_o = 40\text{ mA}$, $0\text{ °C} \leq T_j \leq +125\text{ °C}$, $C_{IN} = 0.33\text{ }\mu\text{F}$, $C_{OUT} = 0.1\text{ }\mu\text{F}$)

CHARACTERISTIC	SYMBOL	TEST CONDITIONS	MIN.	TYP.	MAX.	UNIT
Output Voltage	V_o	$T_j = 25\text{ °C}$	9.6	10	10.4	V
		$12.5\text{ V} \leq V_{IN} \leq 25\text{ V}$, $1\text{ mA} \leq I_o \leq 40\text{ mA}$	9.5		10.5	
		$V_{IN} = 17\text{ V}$, $1\text{ mA} \leq I_o \leq 70\text{ mA}$	9.5		10.5	
Line Regulation	REG _{IN}	$T_j = 25\text{ °C}$, $12.5\text{ V} \leq V_{IN} \leq 25\text{ V}$		12	200	mV
		$T_j = 25\text{ °C}$, $13\text{ V} \leq V_{IN} \leq 25\text{ V}$		8	150	
Load Regulation	REG _L	$T_j = 25\text{ °C}$, $1\text{ mA} \leq I_o \leq 100\text{ mA}$		18	90	mV
		$T_j = 25\text{ °C}$, $1\text{ mA} \leq I_o \leq 40\text{ mA}$		8	45	
Quiescent Current	I _{BIAS}	$T_j = 25\text{ °C}$		2.5	5.5	mA
Quiescent Current Change	ΔI_{BIAS}	$13\text{ V} \leq V_{IN} \leq 25\text{ V}$, $I_o = 40\text{ mA}$			1.5	mA
		$V_{IN} = 17\text{ V}$, $1\text{ mA} \leq I_o \leq 40\text{ mA}$			0.1	
Output Noise Voltage	V_n	$T_j = 25\text{ °C}$, $10\text{ Hz} \leq f \leq 100\text{ kHz}$		100	230	μV _{r.m.s.}
Ripple Rejection	R · R	$T_j = 25\text{ °C}$, $f = 120\text{ Hz}$, $14\text{ V} \leq V_{IN} \leq 24\text{ V}$	49	69		dB
Dropout Voltage	V _{DIF}	$T_j = 25\text{ °C}$		1.7		V
Short Circuit Current	I _{oshort}	$T_j = 25\text{ °C}$, $V_{IN} = 25\text{ V}$		70		mA
Peak Output Current	I _{Opeak}	$T_j = 25\text{ °C}$	125	160	205	mA
Temperature coefficient of Output Voltage	$\Delta V_o / \Delta T$	$I_o = 5\text{ mA}$		0.8		mV/°C

勝特力材料 886-3-5753170
 勝特力电子(上海) 86-21-54151736
 勝特力电子(深圳) 86-755-83298787
[Http://www.100y.com.tw](http://www.100y.com.tw)

ELECTRICAL CHARACTERISTICS μPC78L12

($V_{IN} = 19\text{ V}$, $I_o = 40\text{ mA}$, $0\text{ °C} \leq T_j \leq +125\text{ °C}$, $C_{IN} = 0.33\text{ }\mu\text{F}$, $C_{OUT} = 0.1\text{ }\mu\text{F}$)

CHARACTERISTIC	SYMBOL	TEST CONDITIONS	MIN.	TYP.	MAX.	UNIT
Output Voltage	Vo	$T_j = 25\text{ °C}$	11.5	12	12.5	V
		$14\text{ V} \leq V_{IN} \leq 27\text{ V}$, $1\text{ mA} \leq I_o \leq 40\text{ mA}$	11.4		12.6	
		$V_{IN} = 19\text{ V}$, $1\text{ mA} \leq I_o \leq 70\text{ mA}$	11.4		12.6	
Line Regulation	REG _{IN}	$T_j = 25\text{ °C}$, $14.5\text{ V} \leq V_{IN} \leq 27\text{ V}$		14	250	mV
		$T_j = 25\text{ °C}$, $16\text{ V} \leq V_{IN} \leq 27\text{ V}$		10	200	
Load Regulation	REG _L	$T_j = 25\text{ °C}$, $1\text{ mA} \leq I_o \leq 100\text{ mA}$		20	100	mV
		$T_j = 25\text{ °C}$, $1\text{ mA} \leq I_o \leq 40\text{ mA}$		10	50	
Quiescent Current	I _{BIAS}	$T_j = 25\text{ °C}$		2.6	5.5	mA
Quiescent Current Change	ΔI _{BIAS}	$16\text{ V} \leq V_{IN} \leq 27\text{ V}$, $I_o = 40\text{ mA}$			1.5	mA
		$V_{IN} = 19\text{ V}$, $1\text{ mA} \leq I_o \leq 40\text{ mA}$			0.1	
Output Noise Voltage	V _n	$T_j = 25\text{ °C}$, $10\text{ Hz} \leq f \leq 100\text{ kHz}$		115	280	μV _{r.m.s.}
Ripple Rejection	R · R	$T_j = 25\text{ °C}$, $f = 120\text{ Hz}$, $15\text{ V} \leq V_{IN} \leq 25\text{ V}$	47	66		dB
Dropout Voltage	V _{DIF}	$T_j = 25\text{ °C}$		1.7		V
Short Circuit Current	I _{oshort}	$T_j = 25\text{ °C}$, $V_{IN} = 27\text{ V}$		64		mA
Peak Output Current	I _{Opeak}	$T_j = 25\text{ °C}$	125	160	205	mA
Temperature coefficient of Output Voltage	ΔVo/ΔT	$I_o = 5\text{ mA}$		1.1		mV/°C

ELECTRICAL CHARACTERISTICS μPC78L15

($V_{IN} = 23\text{ V}$, $I_o = 40\text{ mA}$, $0\text{ °C} \leq T_j \leq +125\text{ °C}$, $C_{IN} = 0.33\text{ }\mu\text{F}$, $C_{OUT} = 0.1\text{ }\mu\text{F}$)

CHARACTERISTIC	SYMBOL	TEST CONDITIONS	MIN.	TYP.	MAX.	UNIT
Output Voltage	Vo	$T_j = 25\text{ °C}$	14.4	15	15.6	V
		$17.5\text{ V} \leq V_{IN} \leq 30\text{ V}$, $1\text{ mA} \leq I_o \leq 40\text{ mA}$	14.25		15.75	
		$V_{IN} = 23\text{ V}$, $1\text{ mA} \leq I_o \leq 70\text{ mA}$	14.25		15.75	
Line Regulation	REG _{IN}	$T_j = 25\text{ °C}$, $17.5\text{ V} \leq V_{IN} \leq 30\text{ V}$		18	300	mV
		$T_j = 25\text{ °C}$, $20\text{ V} \leq V_{IN} \leq 30\text{ V}$		13	250	
Load Regulation	REG _L	$T_j = 25\text{ °C}$, $1\text{ mA} \leq I_o \leq 100\text{ mA}$		25	150	mV
		$T_j = 25\text{ °C}$, $1\text{ mA} \leq I_o \leq 40\text{ mA}$		12	75	
Quiescent Current	I _{BIAS}	$T_j = 25\text{ °C}$		2.7	5.5	mA
Quiescent Current Change	ΔI _{BIAS}	$20\text{ V} \leq V_{IN} \leq 30\text{ V}$, $I_o = 40\text{ mA}$			1.5	mA
		$V_{IN} = 23\text{ V}$, $1\text{ mA} \leq I_o \leq 40\text{ mA}$			0.1	
Output Noise Voltage	V _n	$T_j = 25\text{ °C}$, $10\text{ Hz} \leq f \leq 100\text{ kHz}$		135	350	μV _{r.m.s.}
Ripple Rejection	R · R	$T_j = 25\text{ °C}$, $f = 120\text{ Hz}$, $18.5\text{ V} \leq V_{IN} \leq 28.5\text{ V}$	45	61		dB
Dropout Voltage	V _{DIF}	$T_j = 25\text{ °C}$		1.7		V
Short Circuit Current	I _{oshort}	$T_j = 25\text{ °C}$, $V_{IN} = 30\text{ V}$		53		mA
Peak Output Current	I _{Opeak}	$T_j = 25\text{ °C}$	125	160	205	mA
Temperature coefficient of Output Voltage	ΔVo/ΔT	$I_o = 5\text{ mA}$		1.4		mV/°C

勝特力材料 886-3-5753170
 勝特力电子(上海) 86-21-54151736
 勝特力电子(深圳) 86-755-83298787
[Http://www.100y.com.tw](http://www.100y.com.tw)

TYPICAL CHARACTERISTICS (T_a = 25 °C)

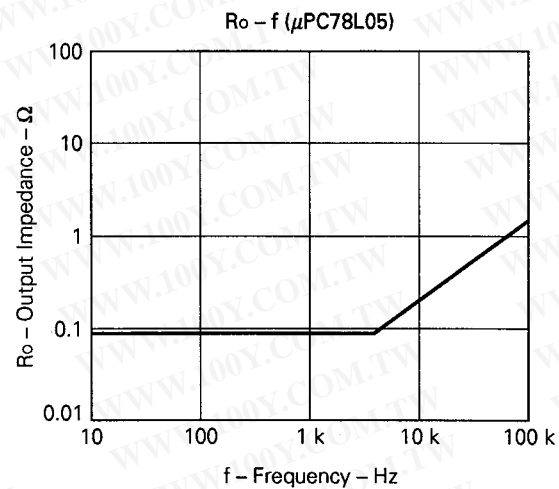
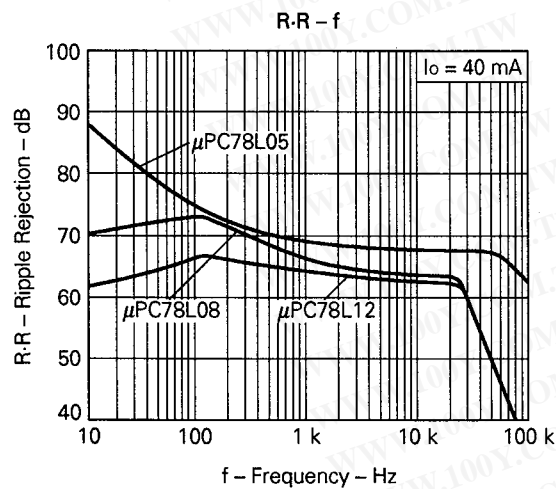
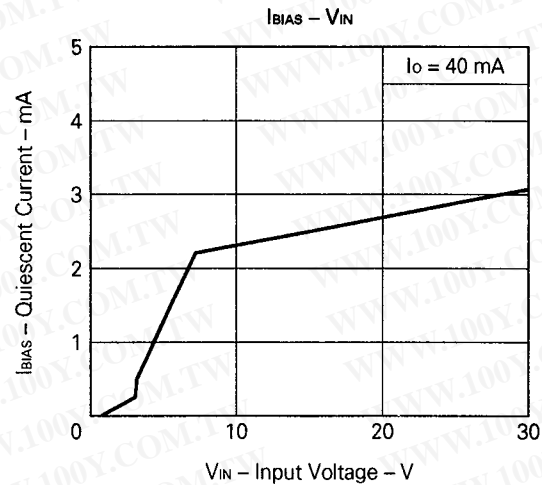
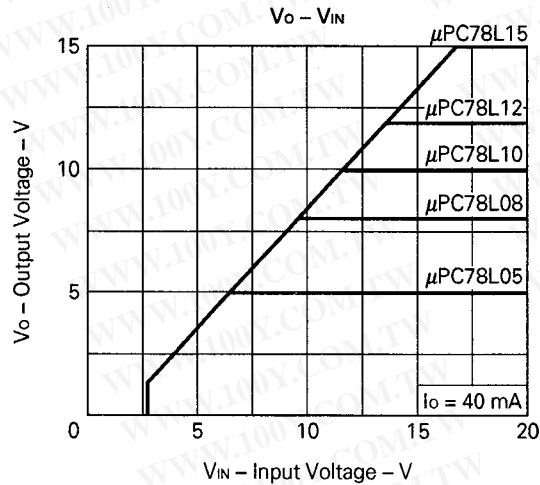
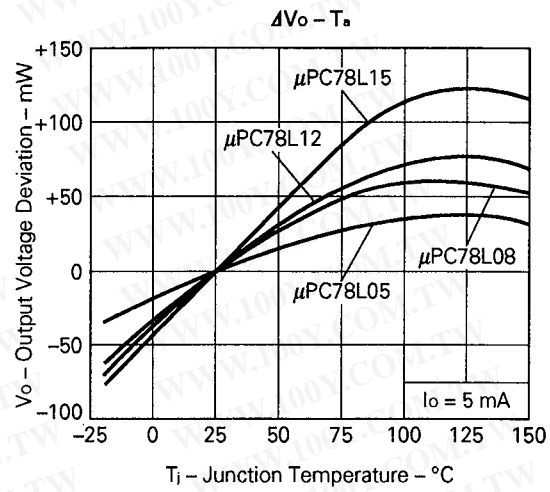
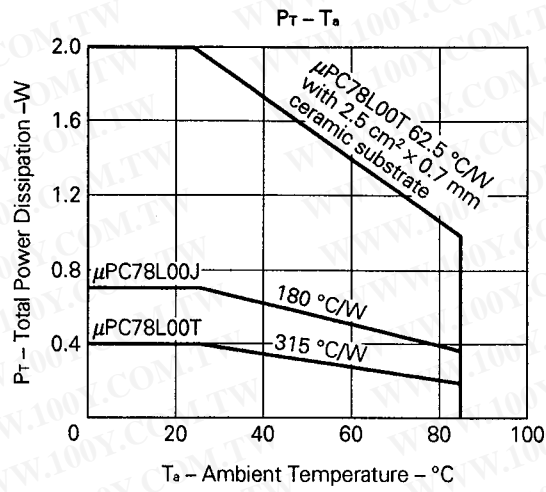

勝特力材料 886-3-5753170
 勝特力电子(上海) 86-21-54151736
 勝特力电子(深圳) 86-755-83298787
[Http://www.100y.com.tw](http://www.100y.com.tw)

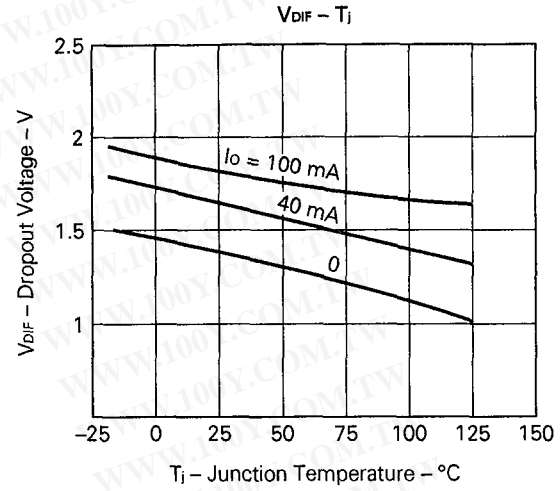
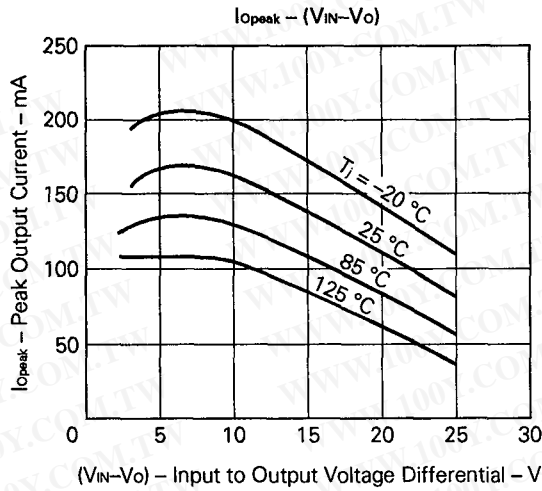

LINE TRANSIENT RESPONSE

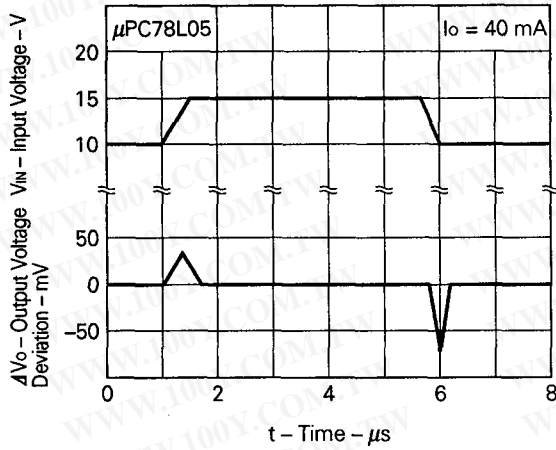

LOAD TRANSIENT RESPONSE

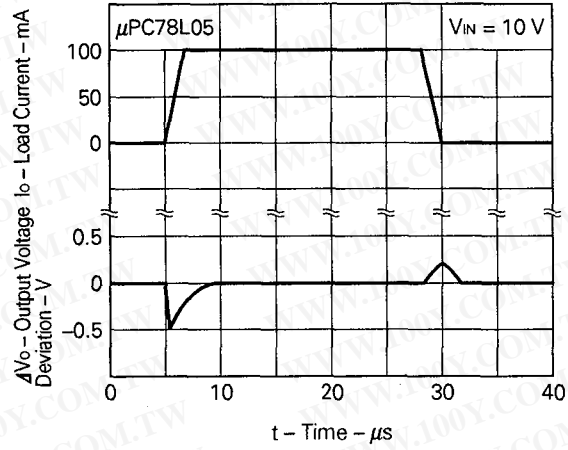

勝特力材料 886-3-5753170
 勝特力电子(上海) 86-21-54151736
 勝特力电子(深圳) 86-755-83298787
[Http://www.100y.com.tw](http://www.100y.com.tw)

PACKAGE DIMENSIONS (Unit: mm)

μPC78L00J Series

3 PIN PLASTIC SIP (TO-92)

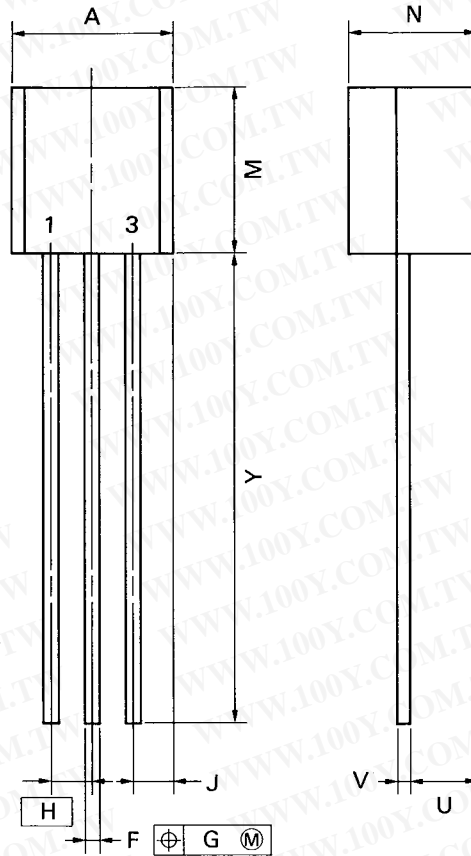

P3J-127B

NOTE

Each lead centerline is located within 0.12 mm (0.005 inch) of its true position (T.P.) at maximum material condition.

ITEM	MILLIMETERS	INCHES
A	5.2 MAX.	0.205 MAX.
F	0.5 ^{+0.1} _{-0.05}	0.02 ^{+0.004} _{-0.002}
G	0.12	0.005
H	1.27	0.05
J	1.33 MAX.	0.053 MAX.
M	5.5 MAX.	0.217 MAX.
N	4.2 MAX.	0.166 MAX.
U	2.8 MAX.	0.111 MAX.
V	0.5 ^{+0.1}	0.02 ^{+0.004}
Y	15.0 ^{+0.7}	0.591 ^{+0.028}

勝特力材料 886-3-5753170
 勝特力电子(上海) 86-21-54151736
 勝特力电子(深圳) 86-755-83298787
[Http://www.100y.com.tw](http://www.100y.com.tw)

μPC78L00T Series

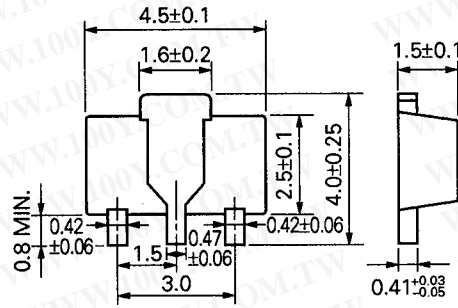

勝特力材料 886-3-5753170
 勝特力电子(上海) 86-21-54151736
 勝特力电子(深圳) 86-755-83298787
[Http://www.100y.com.tw](http://www.100y.com.tw)

RECOMMENDED SOLDERING CONDITIONS

The following conditions (see table below) must be met when soldering this product.

Please consult with our sales offices in case other soldering process is used, or in case soldering is done under different conditions.

<TYPES OF SURFACE MOUNT DEVICE>

For more details, refer to our document "SMT MANUAL" (IEI-1207).

[μPC78L00T Series]

Soldering process	Soldering condition	Symbol
Infrared ray reflow	Peak package's surface temperature: 230 °C or below, Reflow time: 30 seconds or below (210 °C or higher), Number of reflow process: 1, Exposure limit*: None	IR30-00
VPS	Peak package's surface temperature: 215 °C or below, Reflow time: 40 seconds or below (200 °C or higher), Number of reflow process: 1, Exposure limit*: None	VP15-00

*: Exposure limit before soldering after dry-pack package is opened. Storage conditions: 25 °C and relative humidity at 65% or less.

Note: Do not apply more than a single process at once, except for "Partial heating method".

<TYPES OF THROUGH HOLE MOUNT DEVICE>

[μPC78L00J Series]

Soldering process	Soldering condition	Symbol
Wave soldering	Solder temperature: 260 °C or below, Flow time: 10 seconds or below	

勝特力材料 886-3-5753170
 勝特力电子(上海) 86-21-54151736
 勝特力电子(深圳) 86-755-83298787
[Http://www.100y.com.tw](http://www.100y.com.tw)

Reference

Application note name	No.
Quality control of NEC semiconductor devices	TEI-1202
Quality control guide of semiconductor devices	MEI-1202
Assembly manual of semiconductor devices	IEI-1207
NEC semiconductor device reliability/quality control system	IEI-1212

勝特力材料 886-3-5753170
勝特力电子(上海) 86-21-54151736
勝特力电子(深圳) 86-755-83298787
[Http://www.100y.com.tw](http://www.100y.com.tw)

No part of this document may be copied or reproduced in any form or by any means without the prior written consent of NEC Corporation. NEC Corporation assumes no responsibility for any errors which may appear in this document.

NEC Corporation does not assume any liability for infringement of patents, copyrights or other intellectual property rights of third parties by or arising from use of a device described herein or any other liability arising from use of such device. No license, either express, implied or otherwise, is granted under any patents, copyrights or other intellectual property rights of NEC Corporation or others.

The devices listed in this document are not suitable for use in aerospace equipment, submarine cables, nuclear reactor control systems and life support systems. If customers intend to use NEC devices for above applications or they intend to use "Standard" quality grade NEC devices for applications not intended by NEC, please contact our sales people in advance.

Application examples recommended by NEC Corporation.

Standard: Computer, Office equipment, Communication equipment, Test and Measurement equipment, Machine tools, Industrial robots, Audio and Visual equipment, Other consumer products, etc.

Special: Automotive and Transportation equipment, Traffic control systems, Antidisaster systems, Anticrime systems, etc.