

THREE TERMINAL NEGATIVE VOLTAGE REGULATOR

DESCRIPTION

μ PC79N00 series are monolithic three terminal positive regulators which employ internally current limiting, thermal shut-down, output transistor safe operating area protection make them essentially indestructible.

They are intended as fixed voltage regulators in a wide range of application including local on card regulation for elimination of distribution problems associated wide single point regulation.

FEATURES

- Output current in excess of 300 mA.
- Built-in some protection circuits.
(over current protection, SOA protection and thermal shut-down)
- Small package, TO-126.

勝特力材料 886-3-5753170
 勝特力电子(上海) 86-21-54151736
 勝特力电子(深圳) 86-755-83298787
[Http://www.100y.com.tw](http://www.100y.com.tw)

ORDER INFORMATION

TYPE NUMBER	OUTPUT VOLTAGE	PACKAGE	QUALITY GRADE
μ PC79N05H	-5 V	TO-126	Standard
μ PC79N08H	-8 V		
μ PC79N12H	-12 V		
μ PC79N15H	-15 V		
μ PC79N18H	-18 V		
μ PC79N24H	-24 V		

Please refer to "Quality grade on NEC Semiconductor Devices" (Document number IEI-1209) published by NEC Corporation to know the specification of quality grade on the devices and its recommended applications.

EQUIVALENT CIRCUIT

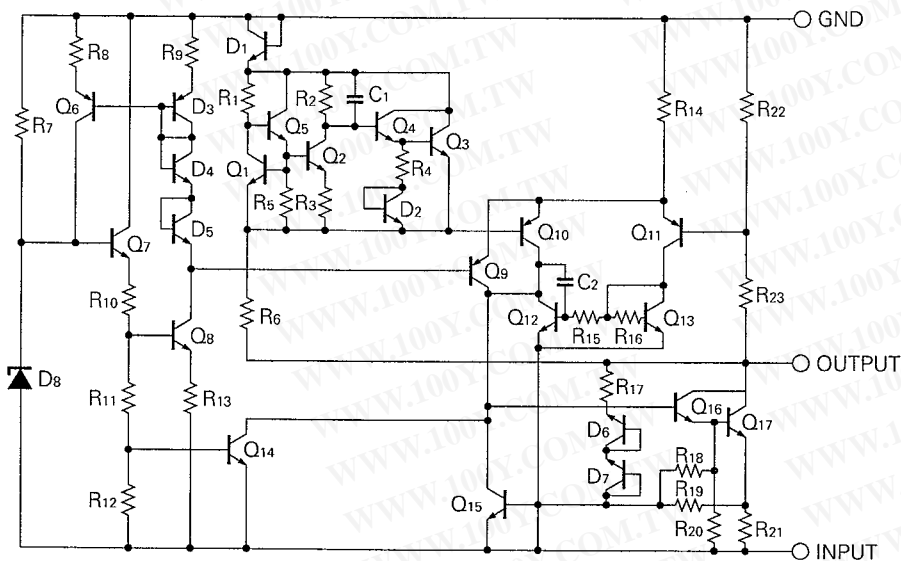

CONNECTION DIAGRAM

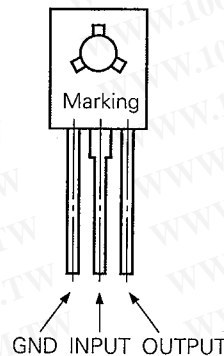

ABSOLUTE MAXIMUM RATINGS (T_a = 25 °C)

CHARACTERISTIC	SYMBOL	RATING	UNIT
Input Voltage	V _{IN}	-35/-40 (Note1)	V
Internal Power Dissipation	P _T	12.5 (Note2)	W
Operating Ambient Temperature Range	T _{opt}	-20 to +85	°C
Operating Junction Temperature Range	T _{opt (j)}	-20 to +150	°C
Storage Temperature Range	T _{stg}	-55 to +150	°C
Thermal Resistance (junction to case)	R _{th (j-c)}	10	°C/W
Thermal Resistance (junction to ambient)	R _{th (j-a)}	110	°C/W

(Note 1) μPC79N05, 08, 12, 15, 18 : -35 V, μPC79N24 : -40 V

(Note 2) Internally limited

TYPICAL CONNECTION

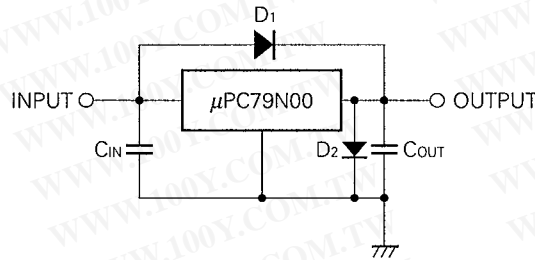

C_{IN}: More than 2.2 μF.

C_{OUT}: More than 1 μF.

D₁: Needed for V_{IN} > V_O.

D₂: Needed for V_O > GND.

RECOMMENDED OPERATING CONDITIONS

CHARACTERISTIC	SYMBOL	TYPE NUMBER	MIN.	TYP.	MAX.	UNIT
Input Voltage	V _{IN}	μPC79N05H	-7	-10	-25	V
		μPC79N08H	-10.5	-14	-25	
		μPC79N12H	-14.5	-19	-30	
		μPC79N15H	-17.5	-23	-30	
		μPC79N18H	-21	-27	-30	
		μPC79N24H	-27	-33	-38	
Output Current	I _O	All	5		300	mA
Operating Junction Temperature Range	T _{opt (j)}	All	-20		+125	°C

勝特力材料 886-3-5753170
 勝特力电子(上海) 86-21-54151736
 勝特力电子(深圳) 86-755-83298787
[Http://www.100y.com.tw](http://www.100y.com.tw)

ELECTRICAL CHARACTERISTICS μPC79N05

($V_{IN} = -10\text{ V}$, $I_o = 200\text{ mA}$, $0\text{ }^\circ\text{C} \leq T_j \leq +125\text{ }^\circ\text{C}$, $C_{IN} = 2.2\text{ }\mu\text{F}$, $C_{OUT} = 1\text{ }\mu\text{F}$)

ITEM	SYMBOL	TEST CONDITIONS	MIN.	TYP.	MAX.	UNIT
Output Voltage	V_o	$T_j = 25\text{ }^\circ\text{C}$	-4.8	-5.0	-5.2	V
		$-7\text{ V} \leq V_{IN} \leq -25\text{ V}$, $5\text{ mA} \leq I_o \leq 200\text{ mA}$	-4.75		-5.25	
Line Regulation	REG _{IN}	$T_j = 25\text{ }^\circ\text{C}$, $-7\text{ V} \leq V_{IN} \leq -25\text{ V}$		7	50	mV
		$T_j = 25\text{ }^\circ\text{C}$, $-8\text{ V} \leq V_{IN} \leq -18\text{ V}$		4	30	
Load Regulation	REG _L	$T_j = 25\text{ }^\circ\text{C}$, $5\text{ mA} \leq I_o \leq 300\text{ mA}$		25	100	mV
		$T_j = 25\text{ }^\circ\text{C}$, $5\text{ mA} \leq I_o \leq 200\text{ mA}$		17		
Quiescent Current	I_{BIAS}	$T_j = 25\text{ }^\circ\text{C}$		4.7	6.0	mA
Quiescent Current Change	ΔI_{BIAS}	$-8\text{ V} \leq V_{IN} \leq -25\text{ V}$			0.5	mA
		$5\text{ mA} \leq I_o \leq 200\text{ mA}$			0.4	
Output Noise Voltage	V_n	$T_j = 25\text{ }^\circ\text{C}$, $10\text{ Hz} \leq f \leq 100\text{ kHz}$		45	200	$\mu\text{V}_{r.m.s.}$
Ripple Rejection	R-R	$T_j = 25\text{ }^\circ\text{C}$, $f = 120\text{ Hz}$, $-8\text{ V} \leq V_{IN} \leq -18\text{ V}$, $I_o = 50\text{ mA}$	54	74		dB
Dropout Voltage	V_{DIF}	$T_j = 25\text{ }^\circ\text{C}$		1.1		V
Short Circuit Current	$I_{o\text{ short}}$	$T_j = 25\text{ }^\circ\text{C}$, $V_{IN} = -25\text{ V}$		310		mA
Peak Output Current	$I_{o\text{ peak}}$	$T_j = 25\text{ }^\circ\text{C}$	390	540	640	mA
Temperature Coefficient of Output Voltage	$\Delta V_o/\Delta T$	$I_o = 5\text{ mA}$		0.1		mV/°C

ELECTRICAL CHARACTERISTICS μPC79N08

($V_{IN} = -14\text{ V}$, $I_o = 200\text{ mA}$, $0\text{ }^\circ\text{C} \leq T_j \leq +125\text{ }^\circ\text{C}$, $C_{IN} = 2.2\text{ }\mu\text{F}$, $C_{OUT} = 1\text{ }\mu\text{F}$)

ITEM	SYMBOL	TEST CONDITIONS	MIN.	TYP.	MAX.	UNIT
Output Voltage	V_o	$T_j = 25\text{ }^\circ\text{C}$	-7.7	-8.0	-8.3	V
		$-10.5\text{ V} \leq V_{IN} \leq -25\text{ V}$, $5\text{ mA} \leq I_o \leq 200\text{ mA}$	-7.6		-8.4	
Line Regulation	REG _{IN}	$T_j = 25\text{ }^\circ\text{C}$, $-10.5\text{ V} \leq V_{IN} \leq -25\text{ V}$		10	80	mV
		$T_j = 25\text{ }^\circ\text{C}$, $-11\text{ V} \leq V_{IN} \leq -21\text{ V}$		5	50	
Load Regulation	REG _L	$T_j = 25\text{ }^\circ\text{C}$, $5\text{ mA} \leq I_o \leq 300\text{ mA}$		30	160	mV
		$T_j = 25\text{ }^\circ\text{C}$, $5\text{ mA} \leq I_o \leq 200\text{ mA}$		20		
Quiescent Current	I_{BIAS}	$T_j = 25\text{ }^\circ\text{C}$		4.8	6.0	mA
Quiescent Current Change	ΔI_{BIAS}	$-10.5\text{ V} \leq V_{IN} \leq -25\text{ V}$			0.5	mA
		$5\text{ mA} \leq I_o \leq 200\text{ mA}$			0.4	
Output Noise Voltage	V_n	$T_j = 25\text{ }^\circ\text{C}$, $10\text{ Hz} \leq f \leq 100\text{ kHz}$		72	220	$\mu\text{V}_{r.m.s.}$
Ripple Rejection	R-R	$T_j = 25\text{ }^\circ\text{C}$, $-11.5\text{ V} \leq V_{IN} \leq -21.5\text{ V}$, $f = 120\text{ Hz}$, $I_o = 50\text{ mA}$	54	69		dB
Dropout Voltage	V_{DIF}	$T_j = 25\text{ }^\circ\text{C}$		1.1		V
Short Circuit Current	$I_{o\text{ short}}$	$T_j = 25\text{ }^\circ\text{C}$, $V_{IN} = -25\text{ V}$		310		mA
Peak Output Current	$I_{o\text{ peak}}$	$T_j = 25\text{ }^\circ\text{C}$	390	540	640	mA
Temperature Coefficient of Output Voltage	$\Delta V_o/\Delta T$	$I_o = 5\text{ mA}$		0.2		mV/°C

勝特力材料 886-3-5753170
 勝特力电子(上海) 86-21-54151736
 勝特力电子(深圳) 86-755-83298787
[Http://www.100y.com.tw](http://www.100y.com.tw)

ELECTRICAL CHARACTERISTICS μPC79N12

($V_{IN} = -19\text{ V}$, $I_o = 200\text{ mA}$, $0\text{ °C} \leq T_j \leq +125\text{ °C}$, $C_{IN} = 2.2\text{ }\mu\text{F}$, $C_{OUT} = 1\text{ }\mu\text{F}$)

ITEM	SYMBOL	TEST CONDITIONS	MIN.	TYP.	MAX.	UNIT
Output Voltage	V_o	$T_j = 25\text{ °C}$	-11.5	-12	-12.5	V
		$-14.5\text{ V} \leq V_{IN} \leq -30\text{ V}$, $5\text{ mA} \leq I_o \leq 200\text{ mA}$	-11.4		-12.6	
Line Regulation	REG _{IN}	$T_j = 25\text{ °C}$, $-14.5\text{ V} \leq V_{IN} \leq -30\text{ V}$		12	80	mV
		$T_j = 25\text{ °C}$, $-15\text{ V} \leq V_{IN} \leq -25\text{ V}$		6	50	
Load Regulation	REG _L	$T_j = 25\text{ °C}$, $5\text{ mA} \leq I_o \leq 300\text{ mA}$		45	240	mV
		$T_j = 25\text{ °C}$, $5\text{ mA} \leq I_o \leq 200\text{ mA}$		30		
Quiescent Current	I _{BIAS}	$T_j = 25\text{ °C}$		5	6.0	mA
Quiescent Current Change	ΔI_{BIAS}	$-14.5\text{ V} \leq V_{IN} \leq -30\text{ V}$			0.5	mA
		$5\text{ mA} \leq I_o \leq 200\text{ mA}$			0.4	
Output Noise Voltage	V_n	$T_j = 25\text{ °C}$, $10\text{ Hz} \leq f \leq 100\text{ kHz}$		110	280	$\mu\text{V}_{r.m.s.}$
Ripple Rejection	R-R	$T_j = 25\text{ °C}$, $f = 120\text{ Hz}$, $-15\text{ V} \leq V_{IN} \leq -25\text{ V}$, $I_o = 50\text{ mA}$	54	62		dB
Dropout Voltage	V_{DIF}	$T_j = 25\text{ °C}$		1.1		V
Short Circuit Current	$I_{O\text{ short}}$	$T_j = 25\text{ °C}$, $V_{IN} = -30\text{ V}$		220		mA
Peak Output Current	$I_{O\text{ peak}}$	$T_j = 25\text{ °C}$	390	540	640	mA
Temperature Coefficient of Output Voltage	$\Delta V_o/\Delta T$	$I_o = 5\text{ mA}$		0.4		mV/°C

ELECTRICAL CHARACTERISTICS μPC79N15

($V_{IN} = -23\text{ V}$, $I_o = 200\text{ mA}$, $0\text{ °C} \leq T_j \leq +125\text{ °C}$, $C_{IN} = 2.2\text{ }\mu\text{F}$, $C_{OUT} = 1\text{ }\mu\text{F}$)

ITEM	SYMBOL	TEST CONDITIONS	MIN.	TYP.	MAX.	UNIT
Output Voltage	V_o	$T_j = 25\text{ °C}$	-14.4	-15	-15.6	V
		$-17.5\text{ V} \leq V_{IN} \leq -30\text{ V}$, $5\text{ mA} \leq I_o \leq 200\text{ mA}$	-14.25		-15.75	
Line Regulation	REG _{IN}	$T_j = 25\text{ °C}$, $-17.5\text{ V} \leq V_{IN} \leq -30\text{ V}$		15	80	mV
		$T_j = 25\text{ °C}$, $-18\text{ V} \leq V_{IN} \leq -28\text{ V}$		8	50	
Load Regulation	REG _L	$T_j = 25\text{ °C}$, $5\text{ mA} \leq I_o \leq 300\text{ mA}$		55	240	mV
		$T_j = 25\text{ °C}$, $5\text{ mA} \leq I_o \leq 200\text{ mA}$		36		
Quiescent Current	I _{BIAS}	$T_j = 25\text{ °C}$		5	6.0	mA
Quiescent Current Change	ΔI_{BIAS}	$-17.5\text{ V} \leq V_{IN} \leq -30\text{ V}$			0.5	mA
		$5\text{ mA} \leq I_o \leq 200\text{ mA}$			0.4	
Output Noise Voltage	V_n	$T_j = 25\text{ °C}$, $10\text{ Hz} \leq f \leq 100\text{ kHz}$		140	360	$\mu\text{V}_{r.m.s.}$
Ripple Rejection	R-R	$T_j = 25\text{ °C}$, $f = 120\text{ Hz}$, $-18.5\text{ V} \leq V_{IN} \leq -28.5\text{ V}$, $I_o = 50\text{ mA}$	52	59		dB
Dropout Voltage	V_{DIF}	$T_j = 25\text{ °C}$		1.1		V
Short Circuit Current	$I_{O\text{ short}}$	$T_j = 25\text{ °C}$, $V_{IN} = -30\text{ V}$		210		mA
Peak Output Current	$I_{O\text{ peak}}$	$T_j = 25\text{ °C}$	390	540	640	mA
Temperature Coefficient of Output Voltage	$\Delta V_o/\Delta T$	$I_o = 5\text{ mA}$		0.4		mV/°C

勝特力材料 886-3-5753170
 勝特力电子(上海) 86-21-54151736
 勝特力电子(深圳) 86-755-83298787
[Http://www.100y.com.tw](http://www.100y.com.tw)

ELECTRICAL CHARACTERISTICS μ PC79N18

($V_{IN} = -27\text{ V}$, $I_o = 200\text{ mA}$, $0\text{ }^\circ\text{C} \leq T_j \leq +125\text{ }^\circ\text{C}$, $C_{IN} = 2.2\text{ }\mu\text{F}$, $C_{OUT} = 1\text{ }\mu\text{F}$)

ITEM	SYMBOL	TEST CONDITIONS	MIN.	TYP.	MAX.	UNIT
Output Voltage	V_o	$T_j = 25\text{ }^\circ\text{C}$	-17.3	-18	-18.7	V
		$-21\text{ V} \leq V_{IN} \leq -33\text{ V}$, $5\text{ mA} \leq I_o \leq 200\text{ mA}$	-17.1		-18.9	
Line Regulation	REG _{IN}	$T_j = 25\text{ }^\circ\text{C}$, $-21\text{ V} \leq V_{IN} \leq -33\text{ V}$		18	80	mV
		$T_j = 25\text{ }^\circ\text{C}$, $-24\text{ V} \leq V_{IN} \leq -33\text{ V}$		10	50	
Load Regulation	REG _L	$T_j = 25\text{ }^\circ\text{C}$, $5\text{ mA} \leq I_o \leq 300\text{ mA}$		65	300	mV
		$T_j = 25\text{ }^\circ\text{C}$, $5\text{ mA} \leq I_o \leq 200\text{ mA}$		43		
Quiescent Current	I_{BIAS}	$T_j = 25\text{ }^\circ\text{C}$		5	6.0	mA
Quiescent Current Change	ΔI_{BIAS}	$-21\text{ V} \leq V_{IN} \leq -33\text{ V}$			0.5	mA
		$5\text{ mA} \leq I_o \leq 200\text{ mA}$			0.4	
Output Noise Voltage	V_n	$T_j = 25\text{ }^\circ\text{C}$, $10\text{ Hz} \leq f \leq 100\text{ kHz}$		170	440	$\mu\text{V}_{r.m.s.}$
Ripple Rejection	R-R	$T_j = 25\text{ }^\circ\text{C}$, $f = 120\text{ Hz}$, $-22\text{ V} \leq V_{IN} \leq -32\text{ V}$, $I_o = 50\text{ mA}$	50	56		dB
Dropout Voltage	V_{DIF}	$T_j = 25\text{ }^\circ\text{C}$		1.1		V
Short Circuit Current	$I_{o\text{ short}}$	$T_j = 25\text{ }^\circ\text{C}$, $V_{IN} = -33\text{ V}$		150		mA
Peak Output Current	$I_{o\text{ peak}}$	$T_j = 25\text{ }^\circ\text{C}$	390	540	640	mA
Temperature Coefficient of Output Voltage	$\Delta V_o/\Delta T$	$I_o = 5\text{ mA}$		0.6		mV/ $^\circ\text{C}$

ELECTRICAL CHARACTERISTICS μ PC79N24

($V_{IN} = -33\text{ V}$, $I_o = 200\text{ mA}$, $0\text{ }^\circ\text{C} \leq T_j \leq +125\text{ }^\circ\text{C}$, $C_{IN} = 2.2\text{ }\mu\text{F}$, $C_{OUT} = 1\text{ }\mu\text{F}$)

ITEM	SYMBOL	TEST CONDITIONS	MIN.	TYP.	MAX.	UNIT
Output Voltage	V_o	$T_j = 25\text{ }^\circ\text{C}$	-23.0	-24	-25.0	V
		$-27\text{ V} \leq V_{IN} \leq -38\text{ V}$, $5\text{ mA} \leq I_o \leq 200\text{ mA}$	-22.8		-25.2	
Line Regulation	REG _{IN}	$T_j = 25\text{ }^\circ\text{C}$, $-27\text{ V} \leq V_{IN} \leq -38\text{ V}$		25	80	mV
		$T_j = 25\text{ }^\circ\text{C}$, $-30\text{ V} \leq V_{IN} \leq -36\text{ V}$		15	50	
Load Regulation	REG _L	$T_j = 25\text{ }^\circ\text{C}$, $5\text{ mA} \leq I_o \leq 300\text{ mA}$		80	360	mV
		$T_j = 25\text{ }^\circ\text{C}$, $5\text{ mA} \leq I_o \leq 200\text{ mA}$		53		
Quiescent Current	I_{BIAS}	$T_j = 25\text{ }^\circ\text{C}$		5.1	6.0	mA
Quiescent Current Change	ΔI_{BIAS}	$-27\text{ V} \leq V_{IN} \leq -38\text{ V}$			0.5	mA
		$5\text{ mA} \leq I_o \leq 200\text{ mA}$			0.4	
Output Noise Voltage	V_n	$T_j = 25\text{ }^\circ\text{C}$, $10\text{ Hz} \leq f \leq 100\text{ kHz}$		230	600	$\mu\text{V}_{r.m.s.}$
Ripple Rejection	R-R	$T_j = 25\text{ }^\circ\text{C}$, $f = 120\text{ Hz}$, $-28\text{ V} \leq V_{IN} \leq -38\text{ V}$, $I_o = 50\text{ mA}$	46	53		dB
Dropout Voltage	V_{DIF}	$T_j = 25\text{ }^\circ\text{C}$		1.1		V
Short Circuit Current	$I_{o\text{ short}}$	$T_j = 25\text{ }^\circ\text{C}$, $V_{IN} = -38\text{ V}$		70		mA
Peak Output Current	$I_{o\text{ peak}}$	$T_j = 25\text{ }^\circ\text{C}$	390	540	640	mA
Temperature Coefficient of Output Voltage	$\Delta V_o/\Delta T$	$I_o = 5\text{ mA}$		0.8		mV/ $^\circ\text{C}$

勝特力材料 886-3-5753170
 勝特力电子(上海) 86-21-54151736
 勝特力电子(深圳) 86-755-83298787
[Http://www.100y.com.tw](http://www.100y.com.tw)

TYPICAL CHARACTERISTICS ($T_a = 25^\circ\text{C}$)

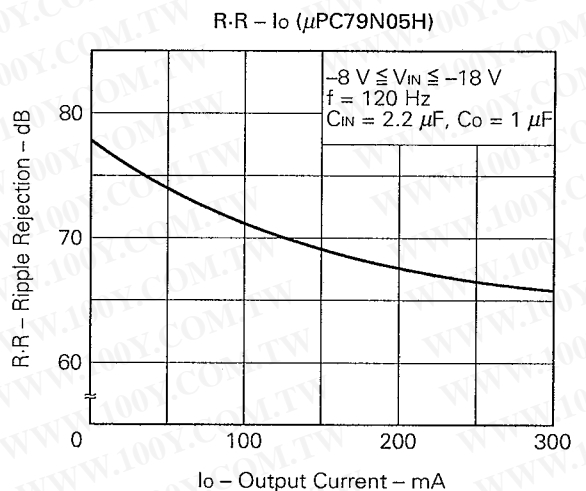
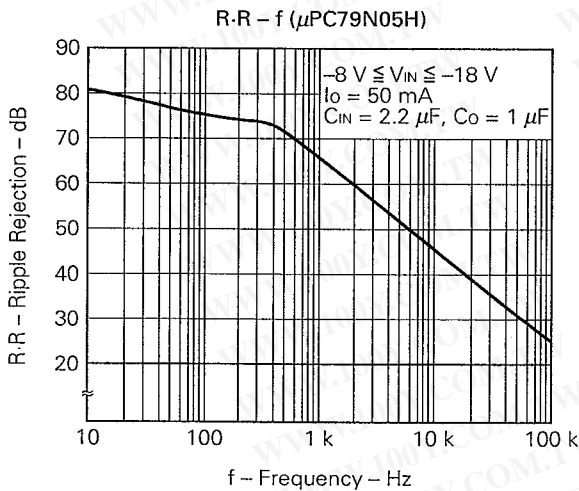
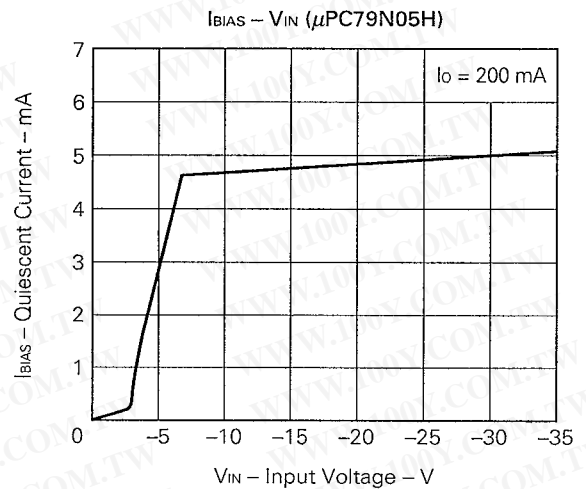
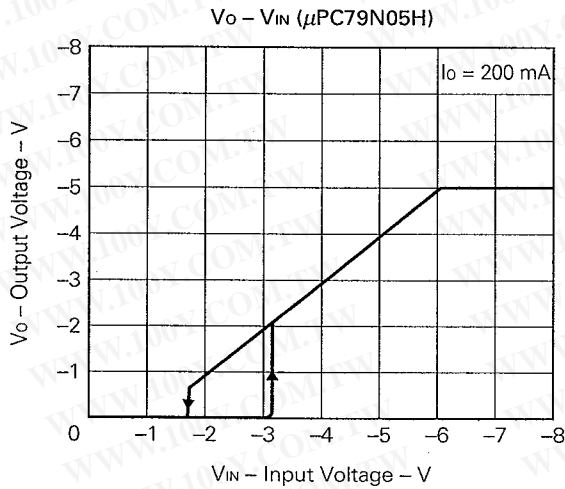
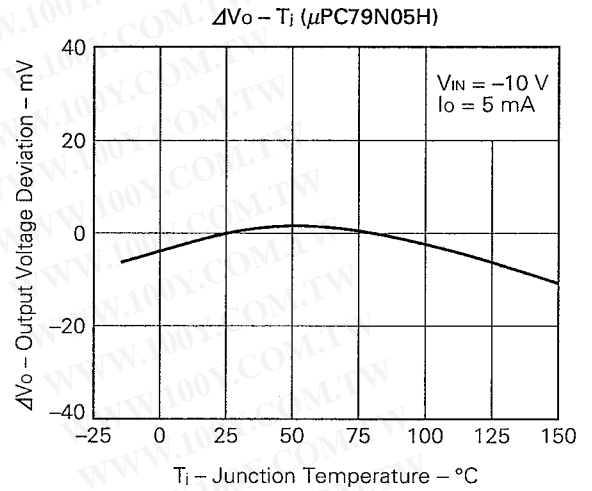
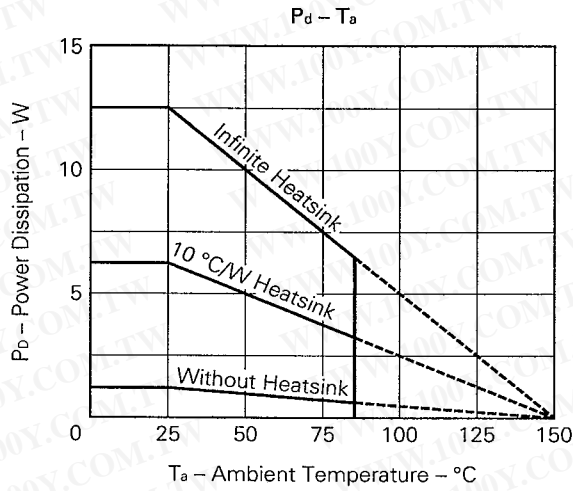

勝特力材料 886-3-5753170
 勝特力电子(上海) 86-21-54151736
 勝特力电子(深圳) 86-755-83298787
[Http://www.100y.com.tw](http://www.100y.com.tw)

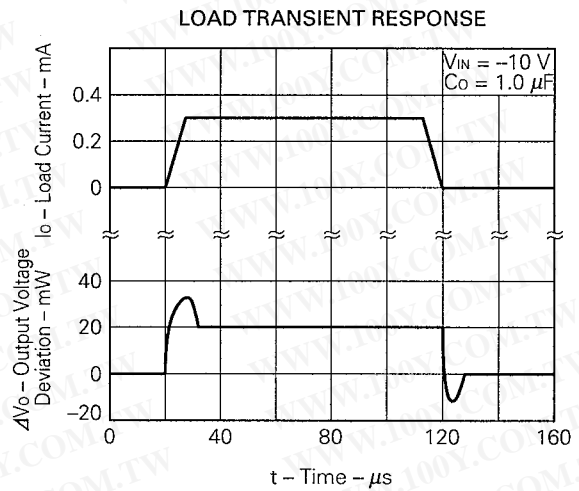
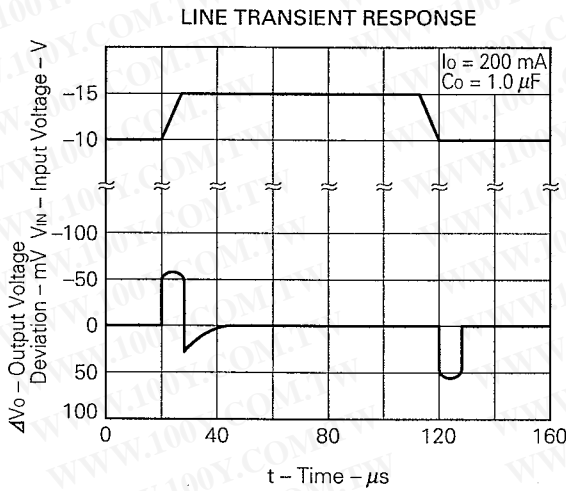
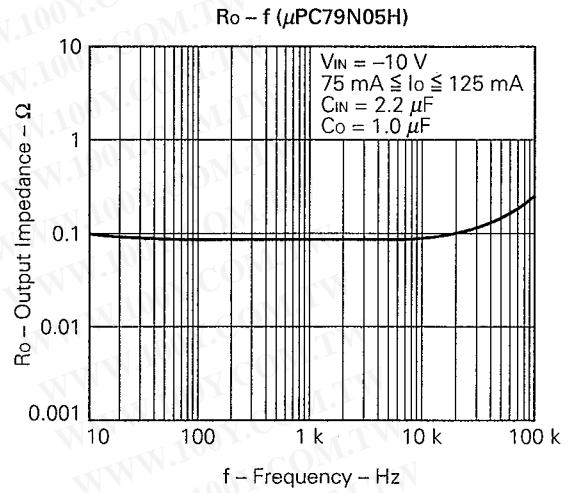
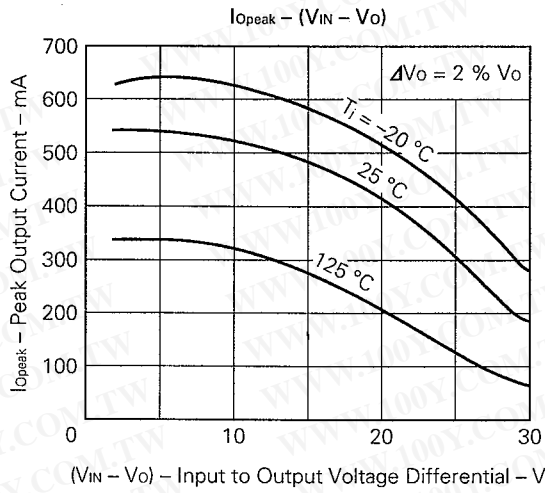

勝特力材料 886-3-5753170
 勝特力电子(上海) 86-21-54151736
 勝特力电子(深圳) 86-755-83298787
[Http://www.100y.com.tw](http://www.100y.com.tw)

PACKAGE DIMENSIONS
3 PIN PLASTIC SIP (TO-126)

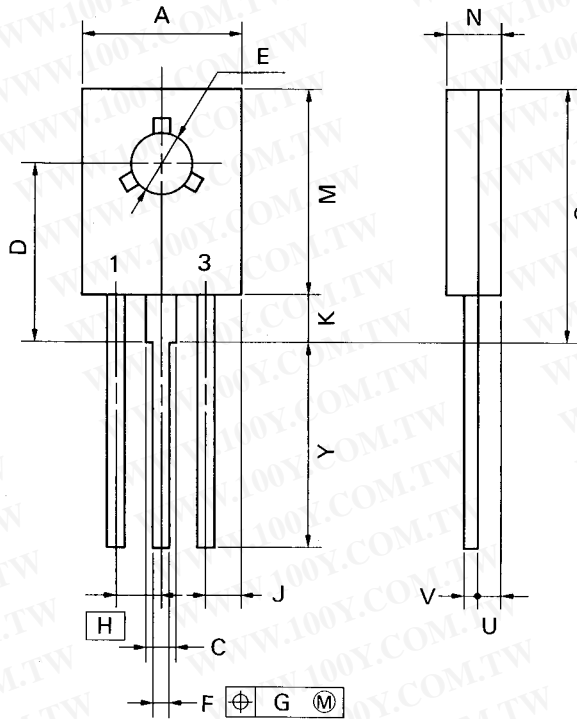

P3HP-230B

NOTE

Each lead centerline is located within 0.23 mm (0.009 inch) of its true position (T.P.) at maximum material condition.

ITEM	MILLIMETERS	INCHES
A	8.5 MAX.	0.335 MAX.
C	1.1 MIN.	0.043 MIN.
D	9.7 ^{+0.3}	0.382 ^{±0.012}
E	φ3.2 ^{±0.1}	φ0.126 ^{±0.004}
F	0.80 ^{±0.1}	0.031 ^{±0.004}
G	0.23	0.009
H	2.3	0.091
J	1.95 MAX.	0.077 MAX.
K	2.3 MIN.	0.09 MIN.
M	11.5 MAX.	0.453 MAX.
N	2.7 ^{±0.2}	0.106 ^{±0.008}
Q	14.5 MAX.	0.571 MAX.
U	1.7 MAX.	0.067 MAX.
V	0.55 ^{±0.1}	0.022 ^{±0.005}
Y	13.5 ^{±0.7}	0.531 ^{±0.028}

勝特力材料 886-3-5753170
 勝特力电子(上海) 86-21-54151736
 勝特力电子(深圳) 86-755-83298787
[Http://www.100y.com.tw](http://www.100y.com.tw)

RECOMMENDED SOLDERING CONDITIONS

The following conditions (see table below) must be met when soldering this product.

Please consult with our sales offices in case other soldering process is used, or in case soldering is done under different conditions.

TYPES OF THROUGH HOLE MOUNT DEVICE

μPC79N00H Series

Soldering process	Soldering conditions	Symbol
Wave soldering	Solder temperature: 260 °C or below. Flow time: 10 seconds or below.	

勝特力材料 886-3-5753170
勝特力电子(上海) 86-21-54151736
勝特力电子(深圳) 86-755-83298787
Http://www.100y.com.tw

Reference

Application note name	No.
Quality control of NEC semiconductor devices	TEM-1202
Quality control guide of semiconductor devices	MEI-1202
Assembly manual of semiconductor devices	IEI-1207
NEC semiconductor device reliability/quality control system	IEI-1212

勝特力材料 886-3-5753170
 勝特力电子(上海) 86-21-54151736
 勝特力电子(深圳) 86-755-83298787
[Http://www.100y.com.tw](http://www.100y.com.tw)

No part of this document may be copied or reproduced in any form or by any means without the prior written consent of NEC Corporation. NEC Corporation assumes no responsibility for any errors which may appear in this document.

NEC Corporation does not assume any liability for infringement of patents, copyrights or other intellectual property rights of third parties by or arising from use of a device described herein or any other liability arising from use of such device. No license, either express, implied or otherwise, is granted under any patents, copyrights or other intellectual property rights of NEC Corporation or others.

The devices listed in this document are not suitable for use in aerospace equipment, submarine cables, nuclear reactor control systems and life support systems. If customers intend to use NEC devices for above applications or they intend to use "Standard" quality grade NEC devices for applications not intended by NEC, please contact our sales people in advance.

Application examples recommended by NEC Corporation.

Standard: Computer, Office equipment, Communication equipment, Test and Measurement equipment, Machine tools, Industrial robots, Audio and Visual equipment, Other consumer products, etc.

Special: Automotive and Transportation equipment, Traffic control systems, Antidisaster systems, Anticrime systems, etc.