

NZL5V6AXV3T1 Series

Preferred Devices

Dual Common Anode ESD Protection Diodes

SC-89 Package

These dual monolithic silicon ESD protection diodes are intended for use in voltage- and ESD-sensitive equipment such as computers, printers, business machines, communication systems, medical equipment and other applications. Their dual junction common anode design protects two separate lines using only one package. These devices are ideal for situations where board space is at a premium.

Specification Features:

- SC-89 Package Allows Either Two Separate Unidirectional Configurations or a Single Bidirectional Configuration
- ESD Rating of Class N (exceeding 16 kV) per the Human Body Model
- Meets IEC61000-4-2 Level 4
- Low Leakage < 5.0 μ A
- These are Pb-Free Devices

Mechanical Characteristics:

CASE: Void-free, Transfer-molded, Thermosetting Plastic Epoxy Meets UL 94, V-0

LEAD FINISH: 100% Matte Sn (Tin)

MOUNTING POSITION: Any

QUALIFIED MAX REFLOW TEMPERATURE:

260°C Device Meets MSL 1 Requirements



ON Semiconductor®

<http://onsemi.com>

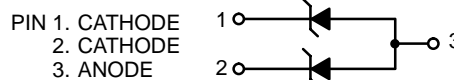

MARKING DIAGRAM



SC-89
CASE 463C
STYLE 4

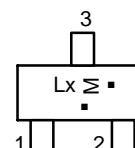

- L = Device Code
- x = Specific Device
- M = Date Code
- = Pb-Free Package

(Note: Microdot may be in either location)

ORDERING INFORMATION

| Device | Package | Shipping† |
|---------------|---------|-------------------|
| NZL5V6AXV3T1 | SC-89* | 3000/Tape & Reel |
| NZL5V6AXV3T1G | SC-89* | 3000/Tape & Reel |
| NZL6V8AXV3T1 | SC-89* | 3000/Tape & Reel |
| NZL6V8AXV3T1G | SC-89* | 3000/Tape & Reel |
| NZL6V8AXV3T3G | SC-89* | 10000/Tape & Reel |
| NZL7V5AXV3T1 | SC-89* | 3000/Tape & Reel |
| NZL7V5AXV3T1G | SC-89* | 3000/Tape & Reel |

†For information on tape and reel specifications, including part orientation and tape sizes, please refer to our Tape and Reel Packaging Specification Brochure, BRD8011/D.

*This package is inherently Pb-Free.

DEVICE MARKING INFORMATION

See specific marking information in the device marking column of the table on page 2 of this data sheet.

Preferred devices are recommended choices for future use and best overall value.

NZL5V6AXV3T1 Series

MAXIMUM RATINGS

| Rating | Symbol | Value | Unit |
|--|-----------------|-------------|----------------------------|
| Total Power Dissipation on FR-5 Board (Note 1) @ $T_A = 25^\circ\text{C}$ Derate above 25°C | P_D | 240 1.9 | mW mW/ $^\circ\text{C}$ |
| Thermal Resistance Junction to Ambient | $R_{\theta JA}$ | 525 | $^\circ\text{C/W}$ |
| Junction and Storage Temperature Range | T_J, T_{stg} | -55 to +150 | $^\circ\text{C}$ |
| Lead Solder Temperature – Maximum (10 Second Duration) | T_L | 260 | $^\circ\text{C}$ |
| IEC61000-4-2 (Contact) | | 10 | kV |

Stresses exceeding Maximum Ratings may damage the device. Maximum Ratings are stress ratings only. Functional operation above the Recommended Operating Conditions is not implied. Extended exposure to stresses above the Recommended Operating Conditions may affect device reliability.

1. FR-5 board with minimum recommended mounting pad.

*Other voltages may be available upon request.

ELECTRICAL CHARACTERISTICS

($T_A = 25^\circ\text{C}$ unless otherwise noted)

UNIDIRECTIONAL (Circuit tied to Pins 1 and 3 or 2 and 3)

| Symbol | Parameter |
|-----------|---|
| V_{RWM} | Working Peak Reverse Voltage |
| I_R | Maximum Reverse Leakage Current @ V_{RWM} |
| V_{BR} | Breakdown Voltage @ I_T |
| I_T | Test Current |
| I_F | Forward Current |
| V_F | Forward Voltage @ I_F |

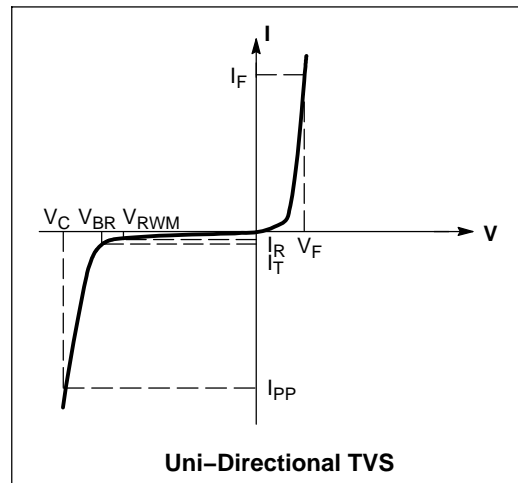

ELECTRICAL CHARACTERISTICS ($T_A = 25^\circ\text{C}$ unless otherwise noted, $V_F = 0.9\text{ V Max}$ @ $I_F = 10\text{ mA}$ for all types)

UNIDIRECTIONAL (Circuit tied to Pins 1 and 3 or Pins 2 and 3)

| Device | Device Marking | V_{RWM} V | I_R @ V_{RWM} μA | Breakdown Voltage | | | | Surge | | | |
|--------------|----------------|----------------|------------------------------------|-----------------------|-----|------|------------------|--|---|-----------------------------|--------------------------------|
| | | | | V_{BR} (Note 2) (V) | | | $@ I_{zT}$ mA | V_C (V) @ $I_{PP} = 1.0\text{ A}^\dagger$ Typ | V_C (V) @ $\text{Max } I_{PP}^\dagger$ Max | Max I_{PP} (A) † | P_{pk} (W) † Typ |
| | | | | Min | Nom | Max | | | | | |
| NZL5V6AXV3T1 | L0 | 3.0 | 5.0 | 5.32 | 5.6 | 5.88 | 5.0 | 7.0 | 10.1 | 4.8 | 50 |
| NZL6V8AXV3T1 | L2 | 4.5 | 1.0 | 6.46 | 6.8 | 7.14 | 5.0 | 7.9 | 11.9 | 6.7 | 73 |
| NZL6V8AXV3T3 | L2 | 4.5 | 1.0 | 6.46 | 6.8 | 7.14 | 5.0 | 7.9 | 11.9 | 6.7 | 73 |
| NZL7V5AXV3T1 | L3 | 5.0 | 1.0 | 7.12 | 7.5 | 7.88 | 5.0 | 8.8 | 13.5 | 5.7 | 75 |

2. V_{BR} measured at pulse test current I_T at an ambient temperature of 25°C .

† Surge current waveform per Figure 5.

NZL5V6AXV3T1 Series

TYPICAL CHARACTERISTICS

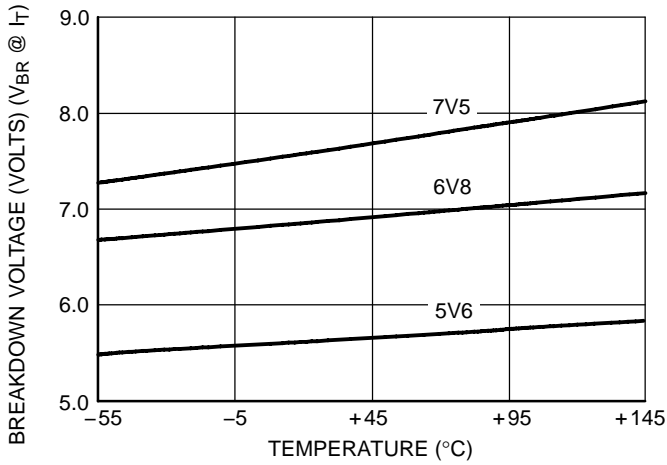

Figure 1. Typical Breakdown Voltage versus Temperature

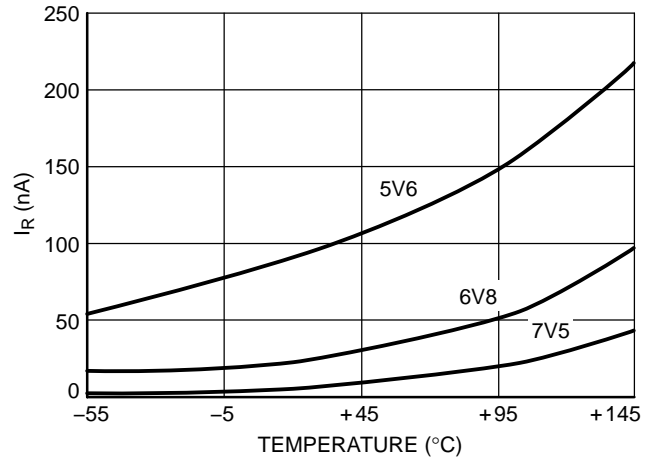

Figure 2. Typical Leakage Current versus Temperature

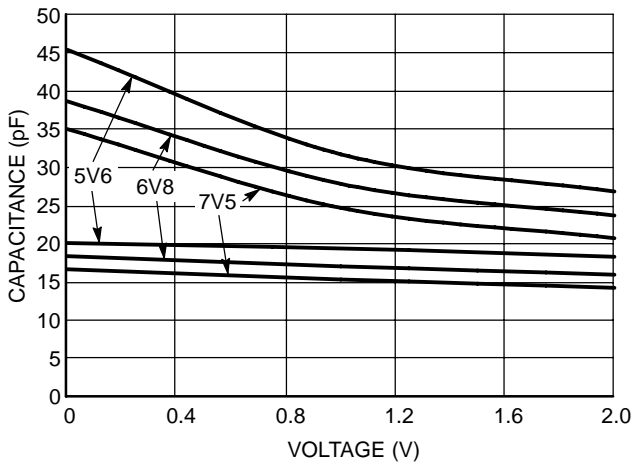

Figure 3. Typical Capacitance versus Bias Voltage
(Upper curve for each part is unidirectional mode, lower curve is bidirectional mode)

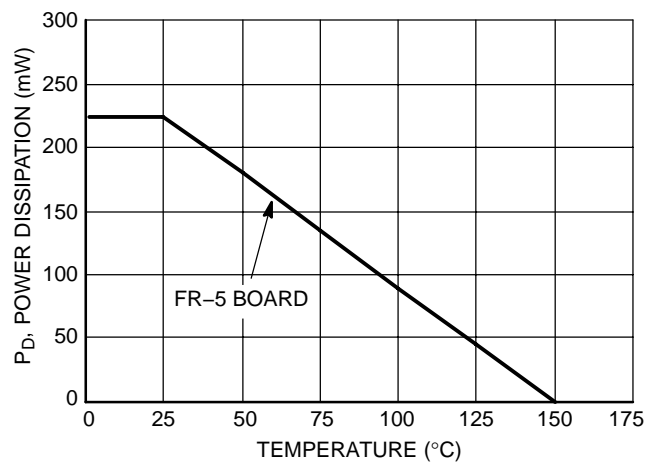

Figure 4. Steady State Power Derating Curve

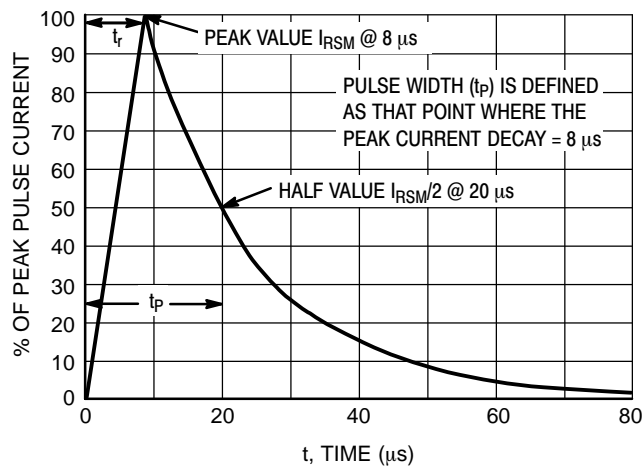

Figure 5. 8 X 20 μs Pulse Waveform

NZL5V6AXV3T1 Series

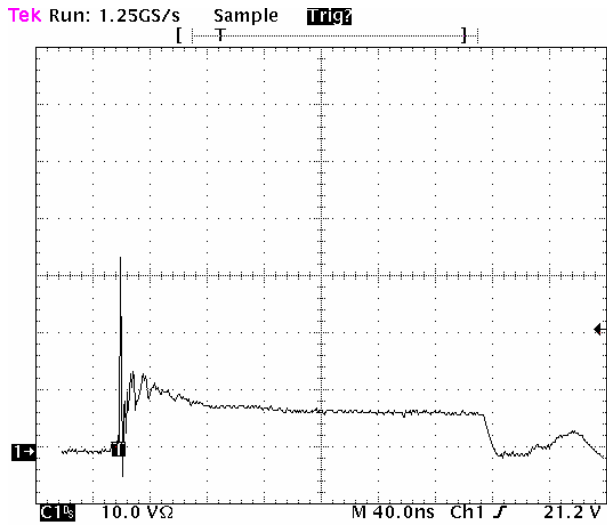

Figure 6. Positive 8 kV contact per IEC 6100-4-2
- NZL6V8AXV3T1G

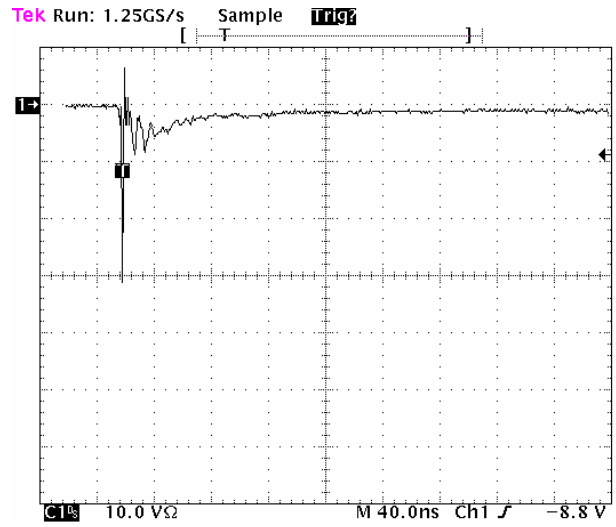

Figure 7. Negative 8 kV contact per IEC 6100-4-2
- NZL6V8AXV3T1G

NZL5V6AXV3T1 Series

TYPICAL COMMON ANODE APPLICATIONS

A dual junction common anode design in an SC-89 package protects two separate lines using only one package. This adds flexibility and creativity to PCB design especially

when board space is at a premium. Two simplified examples of TVS applications are illustrated below.

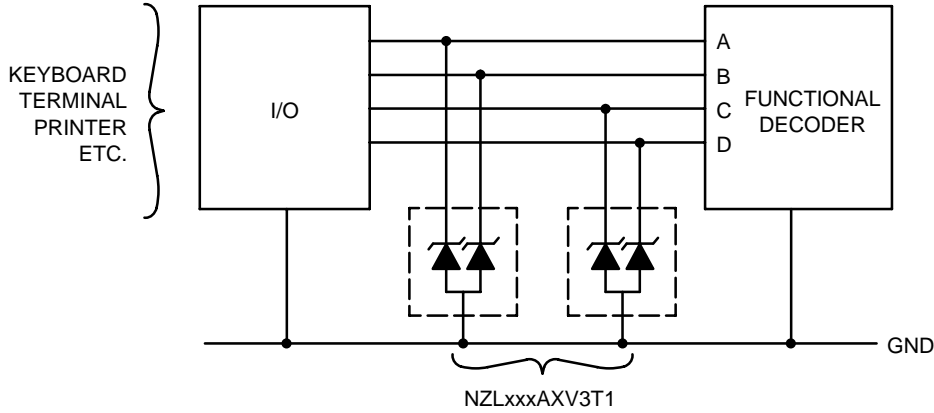

Figure 8. Computer Interface Protection

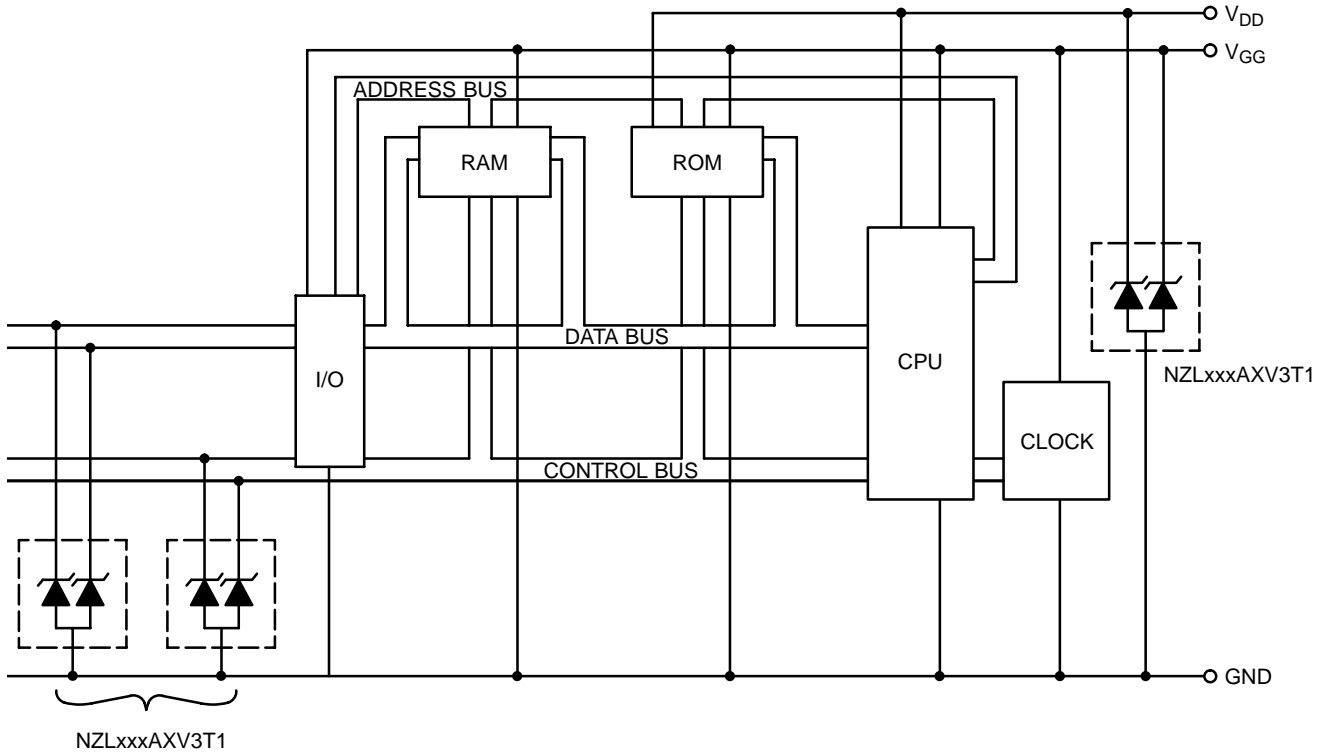
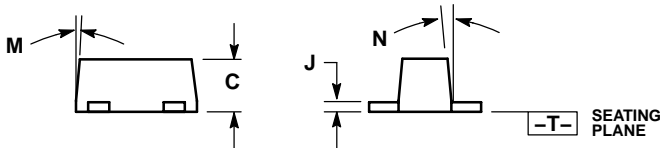
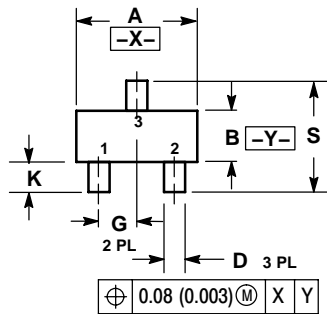

Figure 9. Microprocessor Protection

NZL5V6AXV3T1 Series

PACKAGE DIMENSIONS

SC-89, 3-LEAD
CASE 463C-03
ISSUE C



NOTES:

1. DIMENSIONING AND TOLERANCING PER ANSI Y14.5M, 1982.
2. CONTROLLING DIMENSION: MILLIMETERS
3. MAXIMUM LEAD THICKNESS INCLUDES LEAD FINISH THICKNESS. MINIMUM LEAD THICKNESS IS THE MINIMUM THICKNESS OF BASE MATERIAL.
4. 463C-01 OBSOLETE, NEW STANDARD 463C-02.

| DIM | MILLIMETERS | | | INCHES | | |
|-----|-------------|------|------|-----------|-------|-------|
| | MIN | NOM | MAX | MIN | NOM | MAX |
| A | 1.50 | 1.60 | 1.70 | 0.059 | 0.063 | 0.067 |
| B | 0.75 | 0.85 | 0.95 | 0.030 | 0.034 | 0.040 |
| C | 0.60 | 0.70 | 0.80 | 0.024 | 0.028 | 0.031 |
| D | 0.23 | 0.28 | 0.33 | 0.009 | 0.011 | 0.013 |
| G | 0.50 BSC | | | 0.020 BSC | | |
| H | 0.53 REF | | | 0.021 REF | | |
| J | 0.10 | 0.15 | 0.20 | 0.004 | 0.006 | 0.008 |
| K | 0.30 | 0.40 | 0.50 | 0.012 | 0.016 | 0.020 |
| L | 1.10 REF | | | 0.043 REF | | |
| M | --- | --- | 10 | --- | --- | 10 |
| N | --- | --- | 10 | --- | --- | 10 |
| S | 1.50 | 1.60 | 1.70 | 0.059 | 0.063 | 0.067 |

STYLE 4:

1. CATHODE
2. CATHODE
3. ANODE

SOLDERING FOOTPRINT

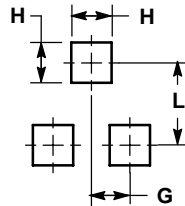

RECOMMENDED PATTERN OF SOLDER PADS

ON Semiconductor and are registered trademarks of Semiconductor Components Industries, LLC (SCILLC). SCILLC reserves the right to make changes without further notice to any products herein. SCILLC makes no warranty, representation or guarantee regarding the suitability of its products for any particular purpose, nor does SCILLC assume any liability arising out of the application or use of any product or circuit, and specifically disclaims any and all liability, including without limitation special, consequential or incidental damages. "Typical" parameters which may be provided in SCILLC data sheets and/or specifications can and do vary in different applications and actual performance may vary over time. All operating parameters, including "Typicals" must be validated for each customer application by customer's technical experts. SCILLC does not convey any license under its patent rights nor the rights of others. SCILLC products are not designed, intended, or authorized for use as components in systems intended for surgical implant into the body, or other applications intended to support or sustain life, or for any other application in which the failure of the SCILLC product could create a situation where personal injury or death may occur. Should Buyer purchase or use SCILLC products for any such unintended or unauthorized application, Buyer shall indemnify and hold SCILLC and its officers, employees, subsidiaries, affiliates, and distributors harmless against all claims, costs, damages, and expenses, and reasonable attorney fees arising out of, directly or indirectly, any claim of personal injury or death associated with such unintended or unauthorized use, even if such claim alleges that SCILLC was negligent regarding the design or manufacture of the part. SCILLC is an Equal Opportunity/Affirmative Action Employer. This literature is subject to all applicable copyright laws and is not for resale in any manner.

PUBLICATION ORDERING INFORMATION

LITERATURE FULFILLMENT:
Literature Distribution Center for ON Semiconductor
P.O. Box 5163, Denver, Colorado 80217 USA
Phone: 303-675-2175 or 800-344-3860 Toll Free USA/Canada
Fax: 303-675-2176 or 800-344-3867 Toll Free USA/Canada
Email: orderlit@onsemi.com

N. American Technical Support: 800-282-9855 Toll Free
USA/Canada
Europe, Middle East and Africa Technical Support:
Phone: 421 33 790 2910
Japan Customer Focus Center
Phone: 81-3-5773-3850

ON Semiconductor Website: www.onsemi.com

Order Literature: <http://www.onsemi.com/orderlit>

For additional information, please contact your local Sales Representative

Mouser Electronics

Authorized Distributor

Click to View Pricing, Inventory, Delivery & Lifecycle Information:

[ON Semiconductor:](#)

[NZL5V6AXV3T1G](#) [NZL6V8AXV3T1G](#) [NZL7V5AXV3T1G](#)