

勝特力材料 886-3-5753170
 勝特力电子(上海) 86-21-54151736
 勝特力电子(深圳) 86-755-83298787
[Http://www.100y.com.tw](http://www.100y.com.tw)

NTP2955

Power MOSFET

-60 V, -12 A, Single P-Channel, TO-220



ON Semiconductor®

<http://onsemi.com>

Features

- Low $R_{DS(on)}$
- Rugged Performance
- Fast Switching
- Pb-Free Package is Available*

Applications

- Industrial
- Automotive
- Power Supplies

$V_{(BR)DSS}$	$R_{DS(on)}$ Typ	I_D MAX
-60 V	156 mΩ @ -10 V	-12 A

MAXIMUM RATINGS ($T_J = 25^\circ\text{C}$ unless otherwise noted)

Parameter	Symbol	Value	Unit
Drain-to-Source Voltage	V_{DSS}	-60	V
Gate-to-Source Voltage	V_{GS}	±20	V
Continuous Drain Current (Note 1)	Steady State	$T_C = 25^\circ\text{C}$	I_D -12 A
		$T_C = 85^\circ\text{C}$	-9.0
Power Dissipation (Note 1)		$T_C = 25^\circ\text{C}$	P_D 62.5 W
Continuous Drain Current (Note 1)	Steady State	$T_A = 25^\circ\text{C}$	I_D -2.4 A
		$T_A = 85^\circ\text{C}$	-1.8
Power Dissipation (Note 1)		$T_A = 25^\circ\text{C}$	P_D 2.4 W
Pulsed Drain Current	$t_p = 10 \mu\text{s}$	I_{DM}	-42 A
Operating Junction and Storage Temperature	T_J, T_{STG}	-55 to 175	°C
Source Current (Body Diode)	I_S	-12	A
Single Pulse Drain-to-Source Avalanche Energy ($V_{DD} = -30 \text{ V}, V_G = -10 \text{ V}, I_{PK} = -12 \text{ A}, L = 3.0 \text{ mH}, R_G = 3.0 \Omega$)	EAS	216	mJ
Lead Temperature for Soldering Purposes (1/8" from case for 10 s)	T_L	260	°C

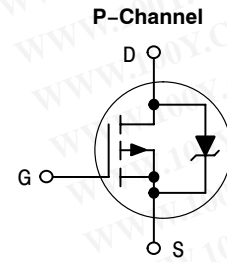

MARKING DIAGRAM & PIN ASSIGNMENT

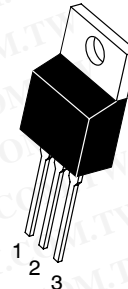

TO-220
CASE 221A
STYLE 5

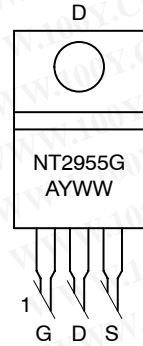

- A = Assembly Location
- Y = Year
- WW = Work Week
- G = Pb-Free Package

THERMAL RESISTANCE RATINGS

Parameter	Symbol	Max	Unit
Junction-to-Case	$R_{\theta JC}$	2.4	°C/W
Junction-to-Ambient - Steady State (Note 1)	$R_{\theta JA}$	62.5	

Stresses exceeding Maximum Ratings may damage the device. Maximum Ratings are stress ratings only. Functional operation above the Recommended Operating Conditions is not implied. Extended exposure to stresses above the Recommended Operating Conditions may affect device reliability.

- When surface mounted to an FR4 board using 1 in pad size (Cu. area = 1.127 in sq [1 oz] including traces).

*For additional information on our Pb-Free strategy and soldering details, please download the ON Semiconductor Soldering and Mounting Techniques Reference Manual, SOLDERRM/D.

ORDERING INFORMATION

Device	Package	Shipping
NTP2955	TO-220	50 Units / Rail
NTP2955G	TO-220 (Pb-Free)	50 Units / Rail

ELECTRICAL CHARACTERISTICS ($T_J=25^\circ\text{C}$ unless otherwise stated)

Parameter	Symbol	Test Condition	Min	Typ	Max	Unit
OFF CHARACTERISTICS						
Drain-to-Source Breakdown Voltage	$V_{(BR)DSS}$	$V_{GS} = 0\text{ V}, I_D = -250\ \mu\text{A}$	-60			V
Drain-to-Source Breakdown Voltage Temperature Coefficient	$V_{(BR)DSS}/T_J$			67		mV/°C
Zero Gate Voltage Drain Current	I_{DSS}	$V_{GS} = 0\text{ V}, V_{DS} = -48\text{ V}$			-1.0	μA
					-10	
Gate-to-Source Leakage Current	I_{GSS}	$V_{DS} = 0\text{ V}, V_{GS} = \pm 20\text{ V}$			± 100	nA

ON CHARACTERISTICS (Note 2)

Gate Threshold Voltage	$V_{GS(TH)}$	$V_{GS} = V_{DS}, I_D = -250\ \mu\text{A}$	-2.0		-4.0	V
Negative Threshold Temperature Coefficient	$V_{GS(TH)}/T_J$			56		mV/°C
Drain-to-Source On Resistance	$R_{DS(on)}$	$V_{GS} = -10\text{ V}, I_D = -12\text{ A}$		156	196	m Ω
Forward Transconductance	g_{FS}	$V_{DS} = -60\text{ V}, I_D = -12\text{ A}$		6.0		S

CHARGES AND CAPACITANCES

Input Capacitance	C_{ISS}	$V_{GS} = 0\text{ V}, f = 1.0\text{ MHz}, V_{DS} = -25\text{ V}$		507	700	pF
Output Capacitance	C_{OSS}			150	250	
Reverse Transfer Capacitance	C_{RSS}			48	98	
Total Gate Charge	$Q_{G(TOT)}$	$V_{GS} = -10\text{ V}, V_{DS} = -48\text{ V}, I_D = -12\text{ A}$		14		nC
Threshold Gate Charge	$Q_{G(TH)}$			1.6	2.5	
Gate-to-Source Charge	Q_{GS}			3.4		
Gate-to-Drain Charge	Q_{GD}			6.2		

SWITCHING CHARACTERISTICS (Note 3)

Turn-On Delay Time	$t_{d(on)}$	$V_{GS} = -10\text{ V}, V_{DD} = -30\text{ V}, I_D = -12\text{ A}, R_G = 9.1\ \Omega$		10	20	ns
Rise Time	t_r			41	80	
Turn-Off Delay Time	$t_{d(off)}$			27	47	
Fall Time	t_f			45	85	

DRAIN-SOURCE DIODE CHARACTERISTICS

Forward Diode Voltage	V_{SD}	$V_{GS} = 0\text{ V}, I_S = -12\text{ A}$	$T_J = 25^\circ\text{C}$		-1.6	-2.0	V
			$T_J = 125^\circ\text{C}$		-1.36		
Reverse Recovery Time	t_{RR}	$V_{GS} = 0\text{ V}, di_S/dt = 100\text{ A}/\mu\text{s}, I_S = -12\text{ A}$			53		ns
Charge Time	t_a				42		
Discharge Time	t_b				12		
Reverse Recovery Charge	Q_{RR}				126		

- Pulse Test: pulse width $\leq 300\ \mu\text{s}$, duty cycle $\leq 2\%$.
- Switching characteristics are independent of operating junction temperatures.

NTP2955

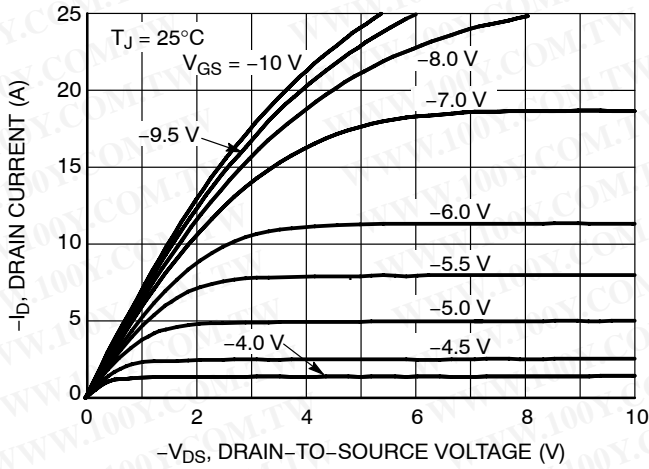

Figure 1. On-Region Characteristics

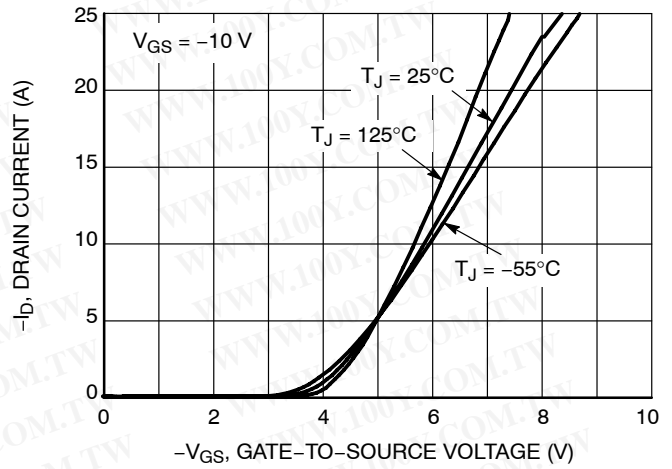

Figure 2. Transfer Characteristics

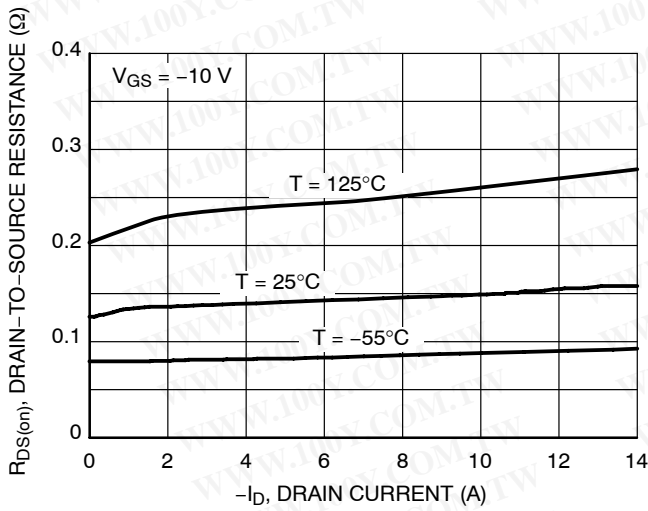

Figure 3. On-Resistance versus Drain Current and Temperature

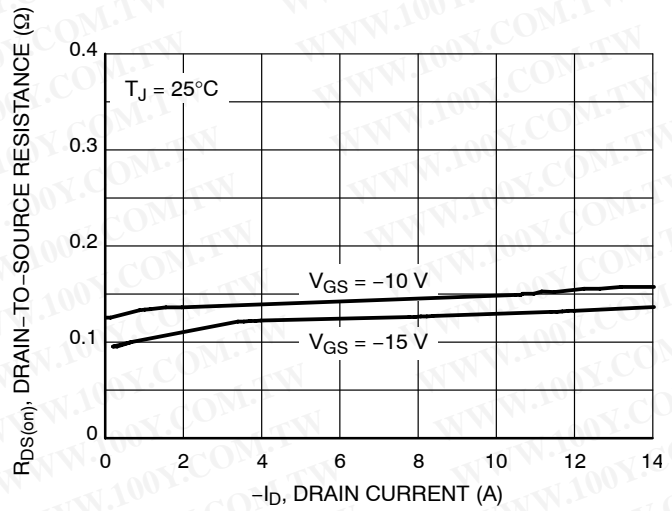

Figure 4. On-Resistance versus Drain Current and Gate Voltage

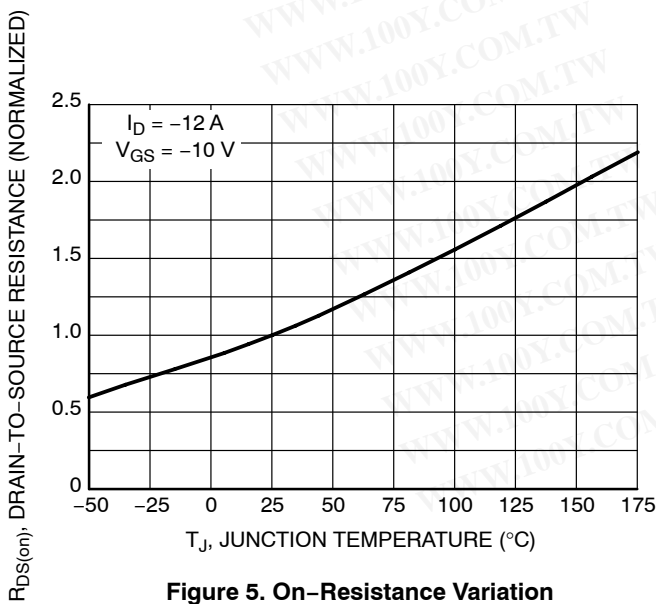

Figure 5. On-Resistance Variation with Temperature

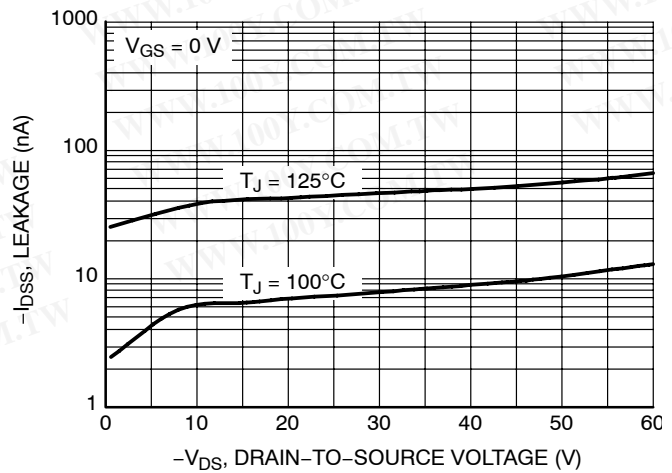

Figure 6. Drain-to-Source Leakage versus Voltage

NTP2955

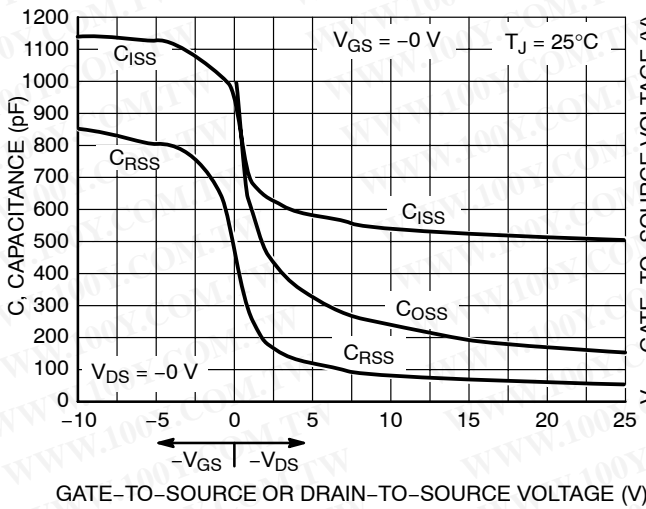

Figure 7. Capacitance Variation

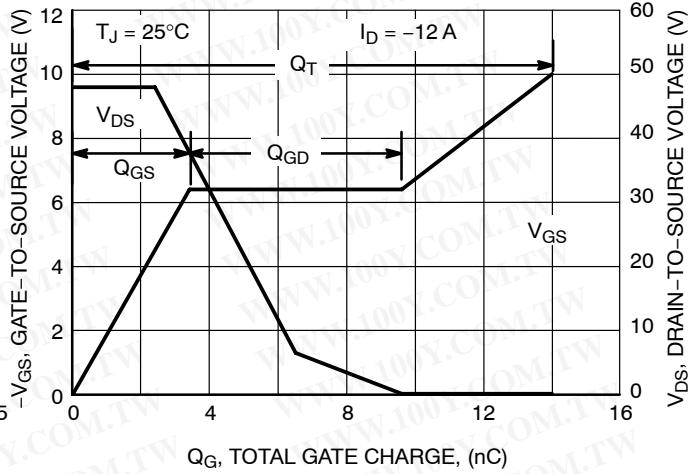

Figure 8. Gate-to-Source and Drain-to-Source Voltage versus Total Charge

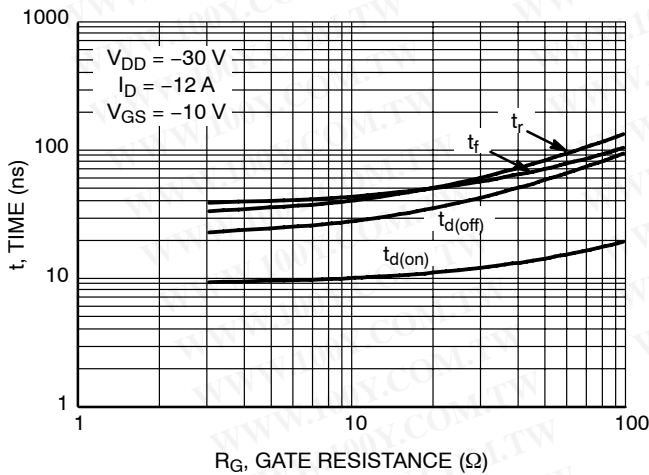

Figure 9. Resistive Switching Time Variation versus Gate Resistance

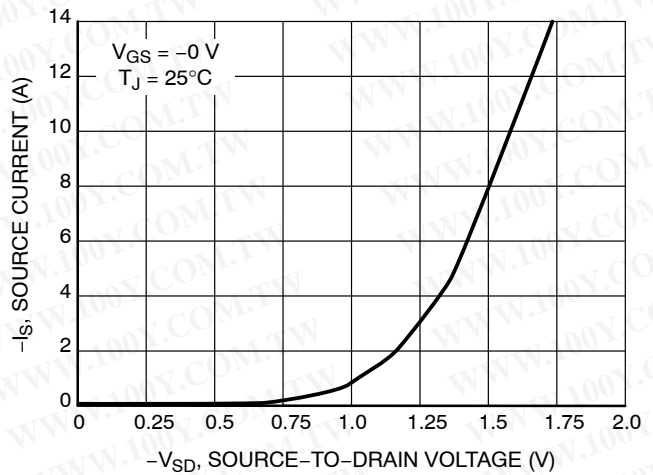

Figure 10. Diode Forward Voltage versus Current

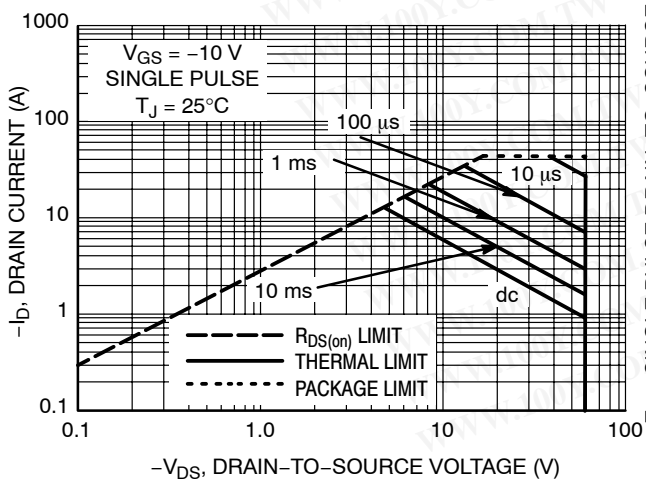

Figure 11. Maximum Rated Forward Biased Safe Operating Area

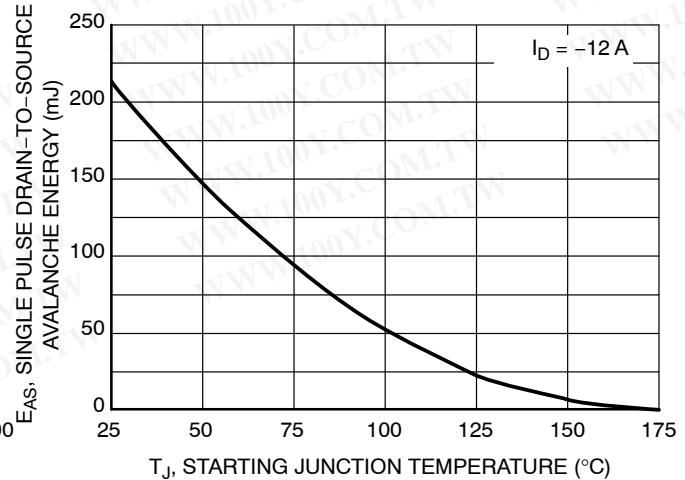

Figure 12. Maximum Avalanche Energy versus Starting Junction Temperature

NTP2955

PACKAGE DIMENSIONS

TO-220
T SUFFIX
PLASTIC PACKAGE
CASE 221A-09
ISSUE AA

勝特力材料 886-3-5753170
勝特力电子(上海) 86-21-54151736
勝特力电子(深圳) 86-755-83298787
[Http://www.100y.com.tw](http://www.100y.com.tw)

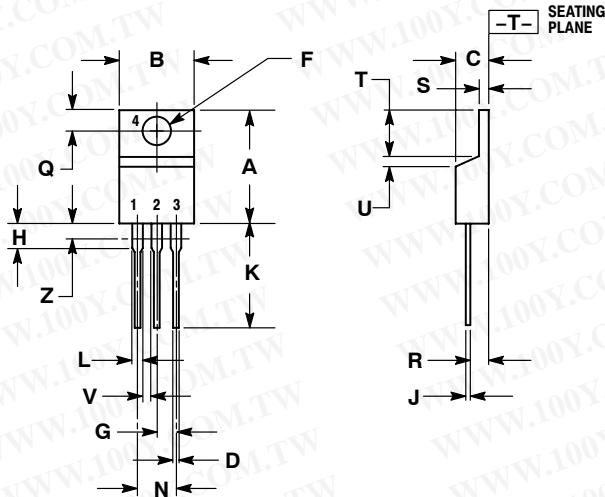

NOTES:

1. DIMENSIONING AND TOLERANCING PER ANSI Y14.5M, 1982.
2. CONTROLLING DIMENSION: INCH.
3. DIMENSION Z DEFINES A ZONE WHERE ALL BODY AND LEAD IRREGULARITIES ARE ALLOWED.

DIM	INCHES		MILLIMETERS	
	MIN	MAX	MIN	MAX
A	0.570	0.620	14.48	15.75
B	0.380	0.405	9.66	10.28
C	0.160	0.190	4.07	4.82
D	0.025	0.035	0.64	0.88
F	0.142	0.147	3.61	3.73
G	0.095	0.105	2.42	2.66
H	0.110	0.155	2.80	3.93
J	0.018	0.025	0.46	0.64
K	0.500	0.562	12.70	14.27
L	0.045	0.060	1.15	1.52
N	0.190	0.210	4.83	5.33
Q	0.100	0.120	2.54	3.04
R	0.080	0.110	2.04	2.79
S	0.045	0.055	1.15	1.39
T	0.235	0.255	5.97	6.47
U	0.000	0.050	0.00	1.27
V	0.045	---	1.15	---
Z	---	0.080	---	2.04

STYLE 5:

- PIN 1. GATE
2. DRAIN
3. SOURCE
4. DRAIN

ON Semiconductor and are registered trademarks of Semiconductor Components Industries, LLC (SCILLC). SCILLC reserves the right to make changes without further notice to any products herein. SCILLC makes no warranty, representation or guarantee regarding the suitability of its products for any particular purpose, nor does SCILLC assume any liability arising out of the application or use of any product or circuit, and specifically disclaims any and all liability, including without limitation special, consequential or incidental damages. "Typical" parameters which may be provided in SCILLC data sheets and/or specifications can and do vary in different applications and actual performance may vary over time. All operating parameters, including "Typicals" must be validated for each customer application by customer's technical experts. SCILLC does not convey any license under its patent rights nor the rights of others. SCILLC products are not designed, intended, or authorized for use as components in systems intended for surgical implant into the body, or other applications intended to support or sustain life, or for any other application in which the failure of the SCILLC product could create a situation where personal injury or death may occur. Should Buyer purchase or use SCILLC products for any such unintended or unauthorized application, Buyer shall indemnify and hold SCILLC and its officers, employees, subsidiaries, affiliates, and distributors harmless against all claims, costs, damages, and expenses, and reasonable attorney fees arising out of, directly or indirectly, any claim of personal injury or death associated with such unintended or unauthorized use, even if such claim alleges that SCILLC was negligent regarding the design or manufacture of the part. SCILLC is an Equal Opportunity/Affirmative Action Employer. This literature is subject to all applicable copyright laws and is not for resale in any manner.

PUBLICATION ORDERING INFORMATION

LITERATURE FULFILLMENT:

Literature Distribution Center for ON Semiconductor
P.O. Box 61312, Phoenix, Arizona 85082-1312 USA
Phone: 480-829-7710 or 800-344-3860 Toll Free USA/Canada
Fax: 480-829-7709 or 800-344-3867 Toll Free USA/Canada
Email: orderlit@onsemi.com

N. American Technical Support: 800-282-9855 Toll Free
USA/Canada

Japan: ON Semiconductor, Japan Customer Focus Center
2-9-1 Kamimeguro, Meguro-ku, Tokyo, Japan 153-0051
Phone: 81-3-5773-3850

ON Semiconductor Website: <http://onsemi.com>

Order Literature: <http://www.onsemi.com/litorder>

For additional information, please contact your local Sales Representative.