



Low Power, High Precision Operational Amplifier

勝特力材料 886-3-5753170
 勝特力电子(上海) 86-21-54151736
 勝特力电子(深圳) 86-755-83298787
 Http://www.100y.com.tw

OP-97

FEATURES

- Low Supply Current 600 μ A Max
- OP-07 Type Performance
 - Offset Voltage 20 μ V Max
 - Offset Voltage Drift 0.6 μ V/ $^{\circ}$ C Max
- Very Low Bias Current
 - 25 $^{\circ}$ C 100pA Max
 - 55 $^{\circ}$ C to +125 $^{\circ}$ C 250pA Max
- High Common-Mode Rejection 114dB Min
- Extended Industrial Temp. Range -40 $^{\circ}$ C to +85 $^{\circ}$ C
- Available in Die Form

GENERAL DESCRIPTION

The OP-97 is a low-power alternative to the industry-standard OP-07 precision amplifier. The OP-97 maintains the standards of performance set by the OP-07 while utilizing only 600 μ A supply current, less than 1/6 that of an OP-07. Offset voltage is an ultra-low 25 μ V, and drift over temperature is below 0.6 μ V/ $^{\circ}$ C. External offset trimming is not required in the majority of circuits.

ORDERING INFORMATION [†]

TO-99	PACKAGE		OPERATING TEMPERATURE RANGE
	CERDIP	PLASTIC	
OP97AJ*	OP97AZ*	-	MIL
OP97EJ	OP97EZ	OP97EP	XIND
OP97FJ	OP97FZ	OP97FP	XIND
-	-	OP97FS ^{††}	XIND

* For devices processed in total compliance to MIL-STD-883, add /883 after part number. Consult factory for 883 data sheet.

[†] Burn-in is available on commercial and industrial temperature range parts in CerDIP, plastic DIP, and TO-can packages.

^{††} For availability and burn-in information on SO and PLCC packages, contact your local sales office.

PIN CONNECTIONS

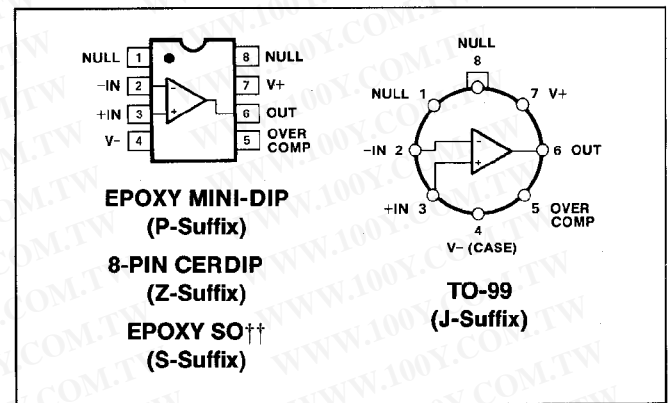

SIMPLIFIED SCHEMATIC

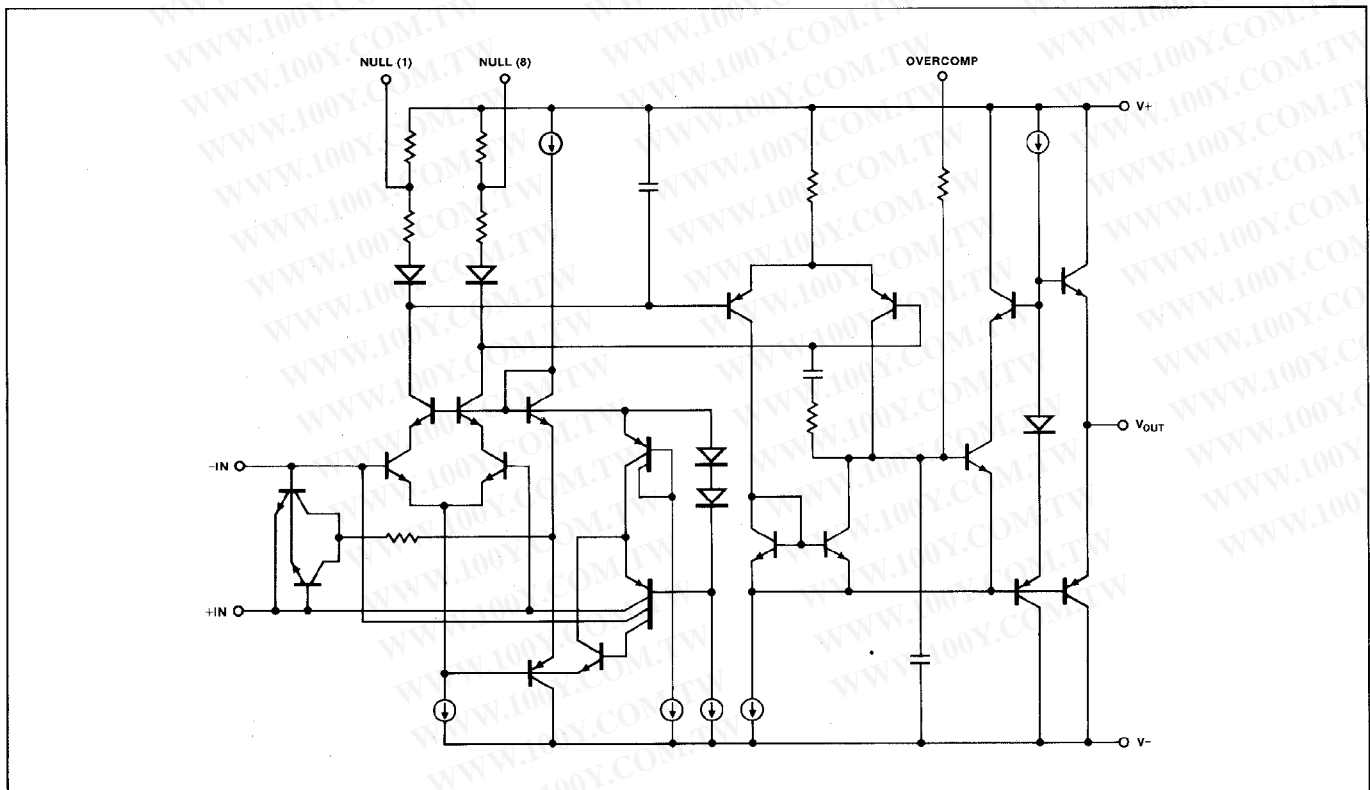

OP-97

Improvements have been made over OP-07 specifications in several areas. Notable is bias current, which remains below 250pA over the full military temperature range. The OP-97 is ideal for use in precision long-term integrators or sample-and-hold circuits that must operate at elevated temperatures.

Common-mode rejection and power-supply rejection are also improved with the OP-97, at 114dB minimum over wider ranges of common-mode or supply voltage. Outstanding PSR, a supply range specified from $\pm 2.25V$ to $\pm 20V$ and the OP-97's minimal power requirements combine to make the OP-97 a preferred device for portable and battery-powered instruments.

The OP-97 conforms to the OP-07 pinout, with the null potentiometer connected between pins 1 and 8 with the wiper to V+. The OP-97 will upgrade circuit designs using 725, OP05, OP07, OP12, and 1012 type amplifiers. It may replace 741-type amplifiers in circuits without nulling or where the nulling circuitry has been removed.

ABSOLUTE MAXIMUM RATINGS (Note 1)

Supply Voltage	$\pm 20V$
Input Voltage (Note 3)	$\pm 20V$
Differential Input Voltage (Note 4)	$\pm 1V$
Differential Input Current (Note 4)	$\pm 10mA$

Output Short-Circuit Duration	Indefinite
Operating Temperature Range	
OP-97A (J, Z)	$-55^{\circ}C$ to $+125^{\circ}C$
OP-97E, F (J, P, Z, S)	$-40^{\circ}C$ to $+85^{\circ}C$
Storage Temperature Range	$-65^{\circ}C$ to $+150^{\circ}C$
Junction Temperature Range	$-65^{\circ}C$ to $+150^{\circ}C$
Lead Temperature (Soldering, 60 sec)	$+300^{\circ}C$

PACKAGE TYPE	θ_{JA} (Note 2)	θ_{JC}	UNITS
TO-99 (J)	150	18	$^{\circ}C/W$
8-Pin Hermetic DIP (Z)	148	16	$^{\circ}C/W$
8-Pin Plastic DIP (P)	103	43	$^{\circ}C/W$
8-Pin SO (S)	158	43	$^{\circ}C/W$

NOTES:

1. Absolute maximum ratings apply to both DICE and packaged parts, unless otherwise noted.
2. θ_{JA} is specified for worst case mounting conditions, i.e., θ_{JA} is specified for device in socket for TO, CerDIP, and P-DIP packages; θ_{JA} is specified for device soldered to printed circuit board for SO package.
3. For supply voltages less than $\pm 20V$, the absolute maximum input voltage is equal to the supply voltage.
4. The OP-97's inputs are protected by back-to-back diodes. Current-limiting resistors are not used in order to achieve low noise. Differential input voltages greater than 1V will cause excessive current to flow through the input protection diodes unless limiting resistance is used.

ELECTRICAL CHARACTERISTICS at $V_S = \pm 15V$, $V_{CM} = 0V$, $T_A = +25^{\circ}C$, unless otherwise noted.

PARAMETER	SYMBOL	CONDITIONS	OP-97A/E			OP-97F			UNITS
			MIN	TYP	MAX	MIN	TYP	MAX	
Input Offset Voltage	V_{OS}		—	10	25	—	30	75	μV
Long-Term Offset Voltage Stability	$\Delta V_{OS}/Time$		—	0.3	—	—	0.3	—	$\mu V/Month$
Input Offset Current	I_{OS}		—	30	100	—	30	150	pA
Input Bias Current	I_B		—	± 30	± 100	—	± 30	± 150	pA
Input Noise Voltage	$e_{n\ p-p}$	0.1Hz to 10Hz	—	0.5	—	—	0.5	—	μV_{p-p}
Input Noise Voltage Density	e_n	$f_O = 10Hz$ (Note 2)	—	17	30	—	17	30	nV/\sqrt{Hz}
		$f_O = 1000Hz$ (Note 3)	—	14	22	—	14	22	nV/\sqrt{Hz}
Input Noise Current Density	i_N	$f_O = 10Hz$	—	20	—	—	20	—	fA/\sqrt{Hz}
Large-Signal Voltage Gain	A_{VO}	$V_O = \pm 10V$; $R_L = 2k\Omega$	300	2000	—	200	2000	—	V/mV
Common-Mode Rejection	CMR	$V_{CM} = \pm 13.5V$	114	132	—	110	132	—	dB
Power-Supply Rejection	PSR	$V_S = \pm 2V$ to $\pm 20V$	114	132	—	110	132	—	dB
Input Voltage Range	IVR	(Note 1)	± 13.5	± 14.0	—	± 13.5	± 14.0	—	V
Output Voltage Swing	V_O	$R_L = 10k\Omega$	± 13	± 14	—	± 13	± 14	—	V
Slew Rate	SR		0.1	0.2	—	0.1	0.2	—	$V/\mu s$

勝特力材料 886-3-5753170
 勝特力电子(上海) 86-21-54151736
 勝特力电子(深圳) 86-755-83298787
[Http://www.100y.com.tw](http://www.100y.com.tw)

ELECTRICAL CHARACTERISTICS at $V_S = \pm 15V$, $V_{CM} = 0V$, $T_A = +25^\circ C$, unless otherwise noted. (Continued.)

PARAMETER	SYMBOL	CONDITIONS	OP-97A/E			OP-97F			UNITS
			MIN	TYP	MAX	MIN	TYP	MAX	
Differential Input Resistance	R_{IN}	(Note 4)	30	—	—	30	—	—	$M\Omega$
Closed-Loop Bandwidth	BW	$A_{VCL} = +1$	0.4	0.9	—	0.4	0.9	—	MHz
Supply Current	I_{SY}		—	380	600	—	380	600	μA
Supply Voltage	V_S	Operating Range	± 2	± 15	± 20	± 2	± 15	± 20	V

NOTES:

1. Guaranteed by CMR test.
2. 10Hz noise voltage density is sample tested. Devices 100% tested for noise are available on request.
3. Sample tested.
4. Guaranteed by design.

ELECTRICAL CHARACTERISTICS at $V_S = \pm 15V$, $V_{CM} = 0V$, $-40^\circ C \leq T_A \leq +85^\circ C$ for the OP-97E/F and $-55^\circ C \leq T_A \leq +125^\circ C$ for the OP-97A, unless otherwise noted.

PARAMETER	SYMBOL	CONDITIONS	OP-97A/E			OP-97F			UNITS
			MIN	TYP	MAX	MIN	TYP	MAX	
Input Offset Voltage	V_{OS}		—	25	60	—	60	200	μV
Average Temperature Coefficient of V_{OS}	TCV_{OS}	S-Package	—	0.2	0.6	—	0.3	2.0	$\mu V/^\circ C$
Input Offset Current	I_{OS}		—	60	250	—	80	750	pA
Average Temperature Coefficient of I_{OS}	TCI_{OS}		—	0.4	2.5	—	0.6	7.5	$pA/^\circ C$
Input Bias Current	I_B		—	± 60	± 250	—	± 80	± 750	pA
Average Temperature Coefficient of I_B	TCI_B		—	0.4	2.5	—	0.6	7.5	$pA/^\circ C$
Large-Signal Voltage Gain	A_{VO}	$V_O = +10V$; $R_L = 2k\Omega$	200	1000	—	150	1000	—	V/mV
Common-Mode Rejection	CMR	$V_{CM} = \pm 13.5V$	108	128	—	108	128	—	dB
Power-Supply Rejection	PSR	$V_S = \pm 2.5V$ to $\pm 20V$	108	126	—	108	128	—	dB
Input Voltage Range	IVR	(Note 1)	± 13.5	± 14.0	—	± 13.5	± 14.0	—	V
Output Voltage Swing	V_O	$R_L = 10k\Omega$	± 13	± 14	—	± 13	± 14	—	V
Slew Rate	SR		0.05	0.15	—	0.05	0.15	—	V/ μs
Supply Current	I_{SY}		—	400	800	—	400	800	μA
Supply Voltage	V_S	Operating Range	± 2.5	± 15	± 20	± 2.5	± 15	± 20	V

NOTES:

1. Guaranteed by CMR test.

勝特力材料 886-3-5753170
 勝特力电子(上海) 86-21-54151736
 勝特力电子(深圳) 86-755-83298787
[Http://www.100y.com.tw](http://www.100y.com.tw)

OP-97

勝特力材料 886-3-5753170
 勝特力电子(上海) 86-21-54151736
 勝特力电子(深圳) 86-755-83298787
[Http://www.100y.com.tw](http://www.100y.com.tw)

DICE CHARACTERISTICS

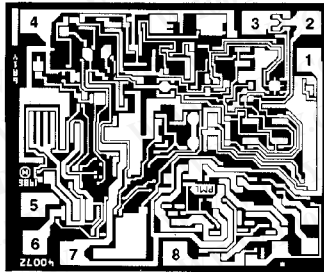

1. NULL
2. INVERTING INPUT
3. NONINVERTING INPUT
4. V-
5. OVERCOMPENSATION
6. OUTPUT
7. V+
8. NULL

DIE SIZE 0.063 × 0.074 inch, 4,662 sq. mils
 (1.60 × 1.88 mm, 3.01 sq. mm)

WAFER TEST LIMITS at $V_S = \pm 15V$, $V_{CM} = 0V$, $T_A = +25^\circ C$, unless otherwise noted.

PARAMETER	SYMBOL	CONDITIONS	OP-97N LIMITS	UNITS
Input Offset Voltage	V_{OS}		250	μV MAX
Input Offset Current	I_{OS}		150	pA MAX
Input Bias Current	I_B		± 150	pA MAX
Large-Signal Voltage Gain	A_{VO}	$V_{OUT} = \pm 10V$, $R_L = 2k\Omega$	120	V/mV MIN
Common-Mode Rejection	CMR	$V_{CM} = \pm 13.5$	110	dB MIN
Power-Supply Rejection	PSR	$V_S = \pm 2V$ to $\pm 20V$	110	dB MIN
Input-Voltage Range	IVR	(Note 1)	± 13.5	V MIN
Output Voltage Swing	V_O	$R_L = 10k\Omega$	± 13	V MIN
Slew Rate	SR		0.1	V/ μs MIN
Supply Current	I_{SY}	No Load	600	μA MAX

NOTES:

1. Guaranteed by CMR test.

Electrical tests are performed at wafer probe to the limits shown. Due to variations in assembly methods and normal yield loss, yield after packaging is not guaranteed for standard product dice. Consult factory to negotiate specifications based on dice lot qualification through sample lot assembly and testing.

TYPICAL PERFORMANCE CHARACTERISTICS

TYPICAL DISTRIBUTION OF INPUT OFFSET VOLTAGE

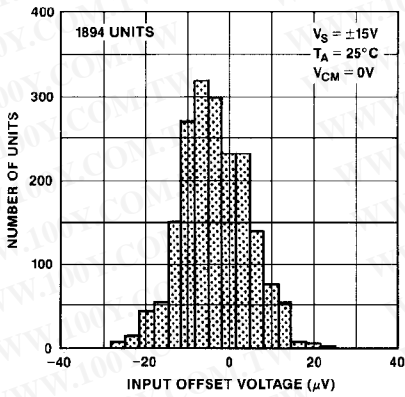

TYPICAL DISTRIBUTION OF INPUT BIAS CURRENT

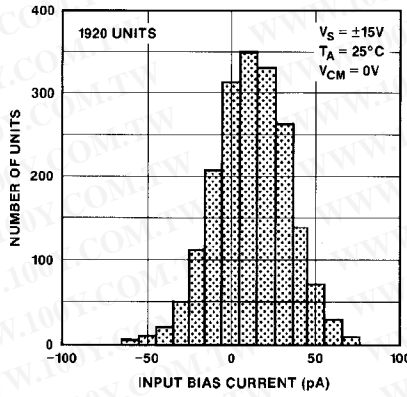

TYPICAL DISTRIBUTION OF INPUT OFFSET CURRENT

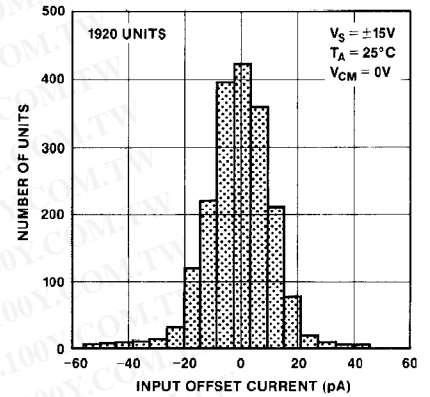

INPUT BIAS, OFFSET CURRENT vs TEMPERATURE

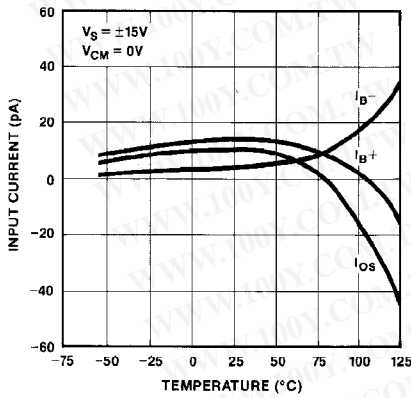

INPUT BIAS, OFFSET CURRENT vs COMMON-MODE VOLTAGE

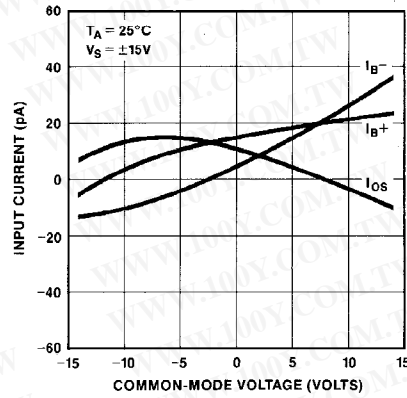

INPUT OFFSET VOLTAGE WARM-UP DRIFT

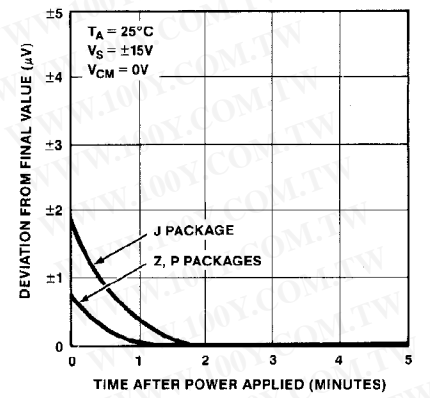

EFFECTIVE OFFSET VOLTAGE vs SOURCE RESISTANCE

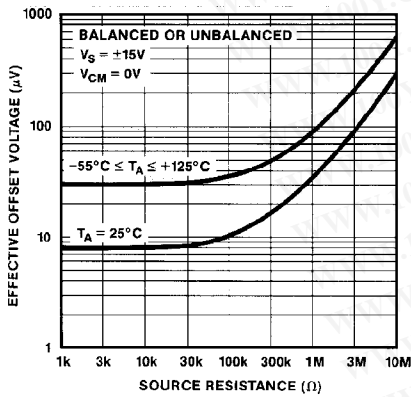

EFFECTIVE TCV_OS vs SOURCE RESISTANCE

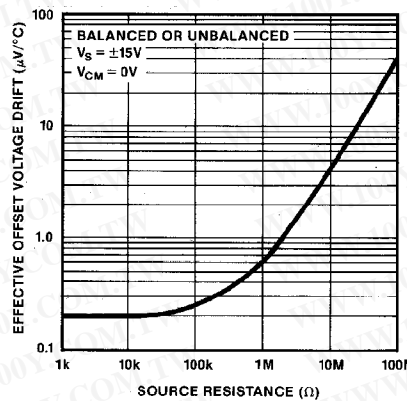

SHORT CIRCUIT CURRENT vs TIME, TEMPERATURE

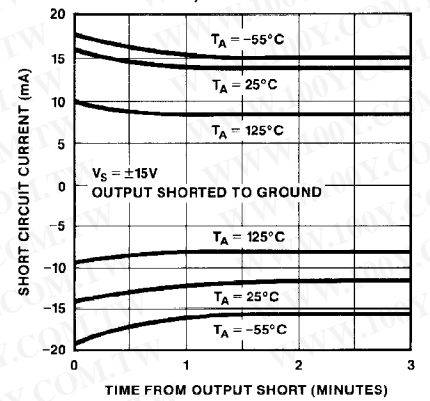

勝特力材料 886-3-5753170
 勝特力电子(上海) 86-21-54151736
 勝特力电子(深圳) 86-755-83298787
[Http://www.100y.com.tw](http://www.100y.com.tw)

TYPICAL PERFORMANCE CHARACTERISTICS

SUPPLY CURRENT vs SUPPLY VOLTAGE

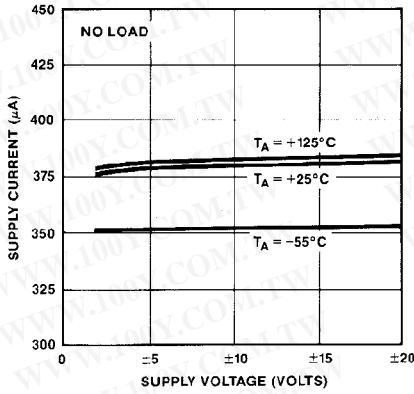

COMMON-MODE REJECTION vs FREQUENCY

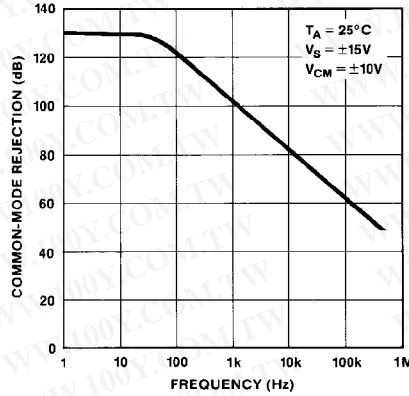

POWER-SUPPLY REJECTION vs FREQUENCY

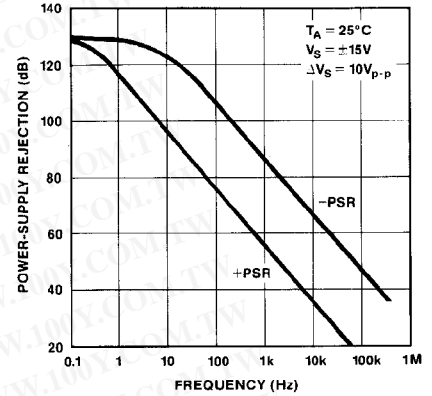

OPEN-LOOP GAIN vs LOAD RESISTANCE

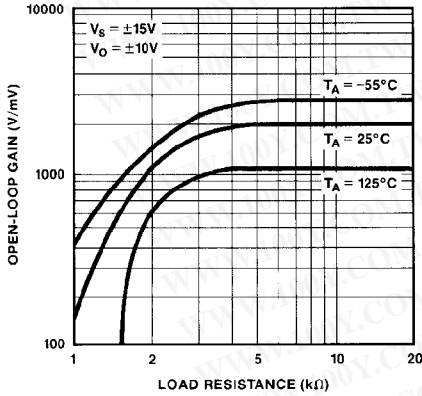

NOISE DENSITY vs FREQUENCY

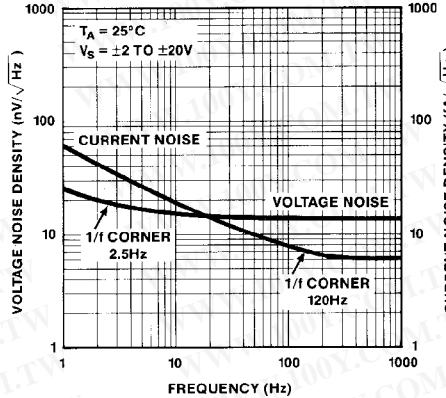

TOTAL NOISE DENSITY vs SOURCE RESISTANCE

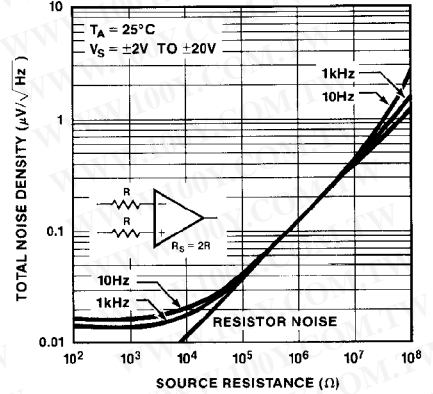

OPEN-LOOP GAIN LINEARITY

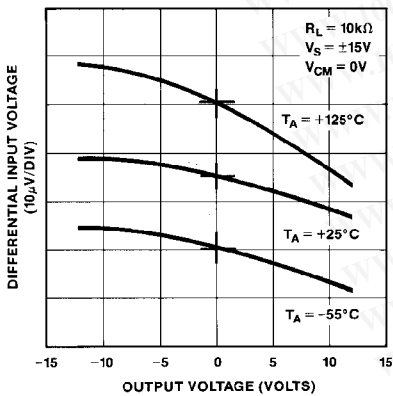

MAXIMUM OUTPUT SWING vs LOAD RESISTANCE

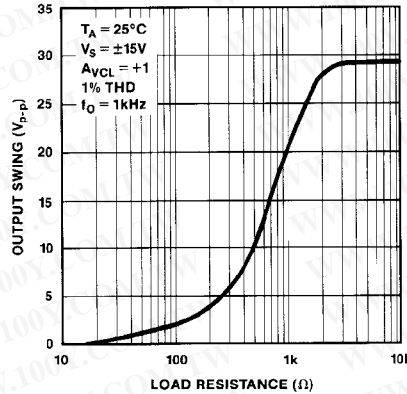

MAXIMUM OUTPUT SWING vs FREQUENCY

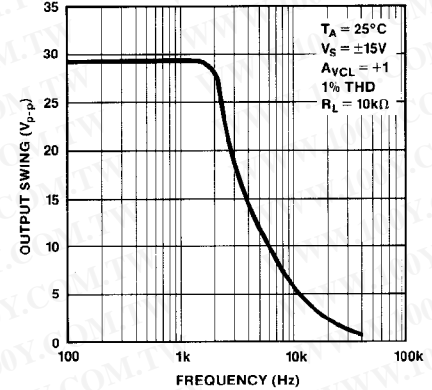

勝特力材料 886-3-5753170
 勝特力电子(上海) 86-21-54151736
 勝特力电子(深圳) 86-755-83298787
[Http://www.100y.com.tw](http://www.100y.com.tw)

TYPICAL PERFORMANCE CHARACTERISTICS

OPEN-LOOP GAIN, PHASE vs FREQUENCY
 ($C_{OC} = 0pF$)

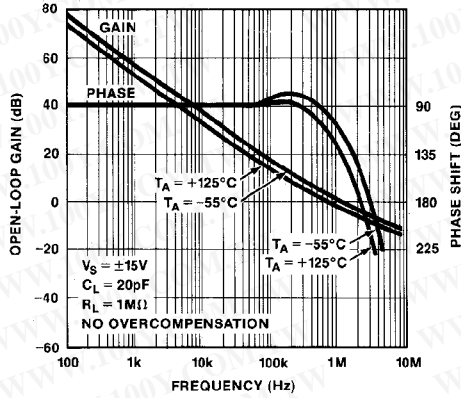

TOTAL HARMONIC DISTORTION PLUS NOISE vs FREQUENCY

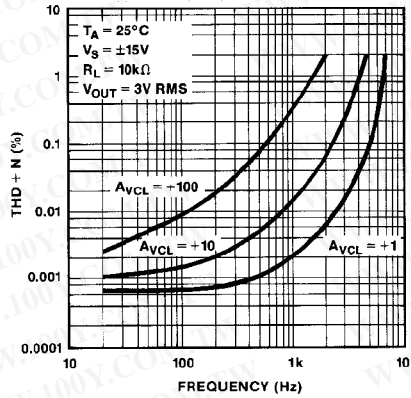

SMALL-SIGNAL OVERSHOOT vs CAPACITIVE LOAD

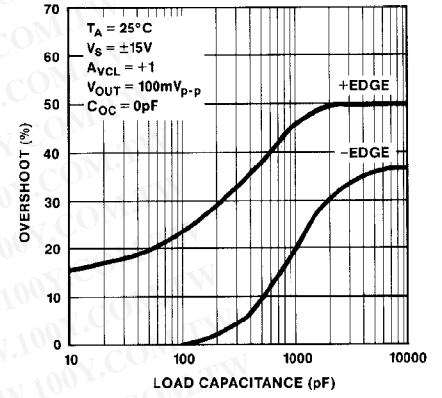

OPEN-LOOP GAIN, PHASE vs FREQUENCY
 ($C_{OC} = 100pF$)

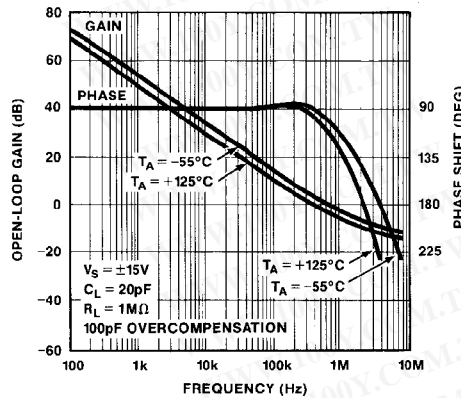

SLEW RATE vs OVERCOMPENSATION

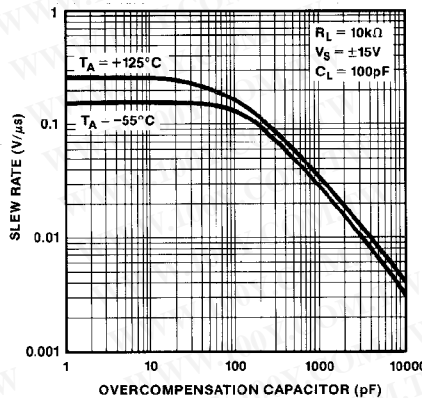

GAIN-BANDWIDTH PRODUCT vs OVERCOMPENSATION

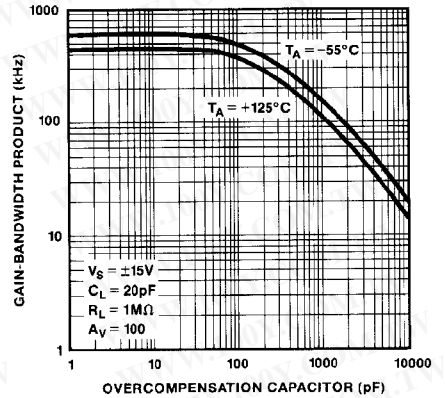

OPEN-LOOP GAIN, PHASE vs FREQUENCY
 ($C_{OC} = 1000pF$)

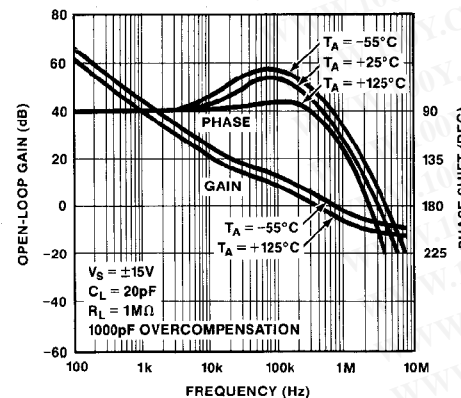

OPEN-LOOP GAIN, PHASE vs FREQUENCY
 ($C_{OC} = 10,000pF$)

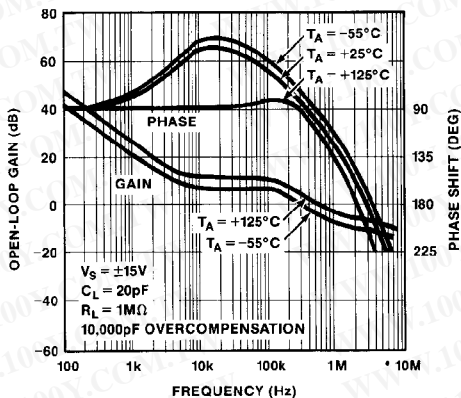

CLOSED-LOOP OUTPUT RESISTANCE vs FREQUENCY

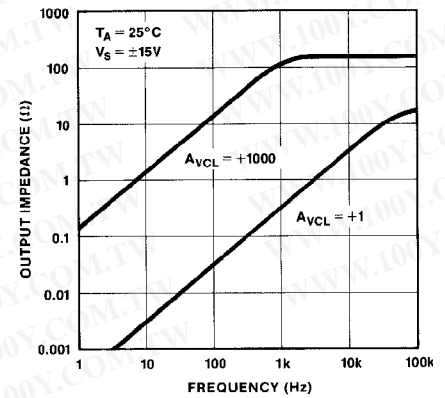

OP-97

勝特力材料 886-3-5753170
勝特力电子(上海) 86-21-54151736
勝特力电子(深圳) 86-755-83298787
[Http://www.100y.com.tw](http://www.100y.com.tw)

APPLICATIONS INFORMATION

The OP-97 is a low-power alternative to the industry standard precision op amp, the OP-07. The OP-97 may be substituted directly into OP-07, OP-77, 725, OP-05, 112/312, and 1012 sockets with improved performance and/or less power dissipation, and may be inserted into sockets conforming to the 741 pinout if nulling circuitry is not used. Generally, nulling circuitry used with earlier generation amplifiers is rendered superfluous by the OP-97's extremely low offset voltage, and may be removed without compromising circuit performance.

Extremely low bias current over the full military temperature range makes the OP-97 attractive for use in sample-and-hold amplifiers, peak detectors, and log amplifiers that must operate over a wide temperature range. Balancing input resistances is not necessary with the OP-97. Offset voltage and TCV_{OS} are degraded only minimally by high source resistance, even when unbalanced.

The input pins of the OP-97 are protected against large differential voltage by back-to-back diodes. Current-limiting resistors are not used so that low-noise performance is maintained. If differential voltages above $\pm 1V$ are expected at the inputs, series resistors must be used to limit the current flow to a maximum of 10mA. Common-mode voltages at the inputs are not restricted, and may vary over the full range of the supply voltages used.

The OP-97 requires very little operating headroom about the supply rails, and is specified for operation with supplies as low

as $\pm 2V$. Typically, the common-mode range extends to within one volt of either rail. The output typically swings to within one volt of the rails when using a 10k Ω load.

Offset nulling is achieved utilizing the same circuitry as an OP-07. A potentiometer between 5k Ω and 100k Ω is connected between pins 1 and 8 with the wiper connected to the positive supply. The trim range is between 300 μV and 850 μV , depending upon the internal trimming of the device.

AC PERFORMANCE

The OP-97's AC characteristics are highly stable over its full operating temperature range. Unity-gain small signal response is shown in Figure 2. Extremely tolerant of capacitive loading on the output, the OP-97 displays excellent response even with 1000pF loads (Figure 3). In large-signal applications, the input protection diodes effectively short the input to the output during the transients if the amplifier is connected in the usual unity-gain configuration. The output enters short-circuit current limit, with the flow going through the protection diodes. Improved large-signal transient response is obtained by using a feedback resistor between the output and the inverting input. Figure 4 shows the large-signal response of the OP-97 in unity-gain with a 10k Ω feedback resistor. The unity gain follower circuit is shown in Figure 5.

The overcompensation pin may be used to increase the phase margin of the OP-97, or to decrease gain-bandwidth product at gains greater than 10.

FIGURE 1: Optional Input Offset Voltage Nulling and Over-compensation Circuits

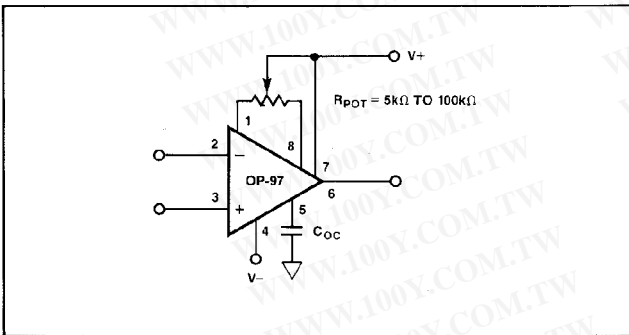

FIGURE 2: Small Signal Transient Response ($C_{LOAD} = 100pF, A_{VCL} = +1$)

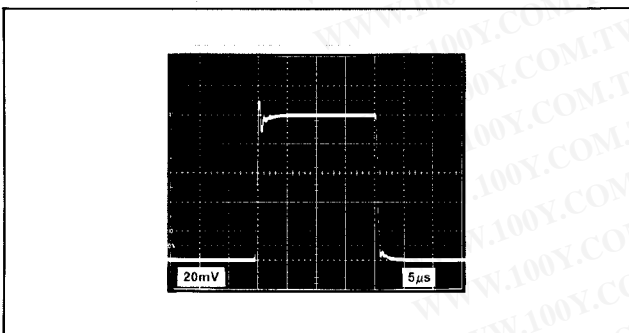

FIGURE 3: Small-Signal Transient Response ($C_{LOAD} = 1000pF, A_{VCL} = +1$)

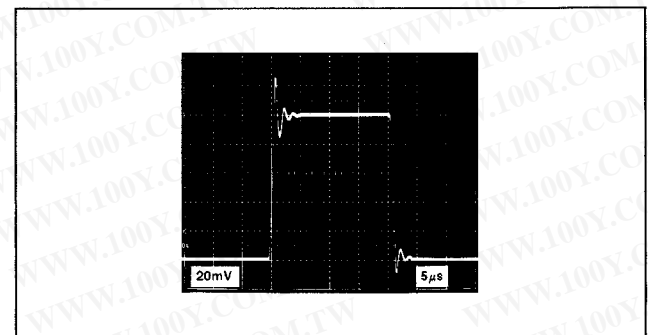

FIGURE 4: Large Signal Transient Response ($A_{VCL} = +1$)

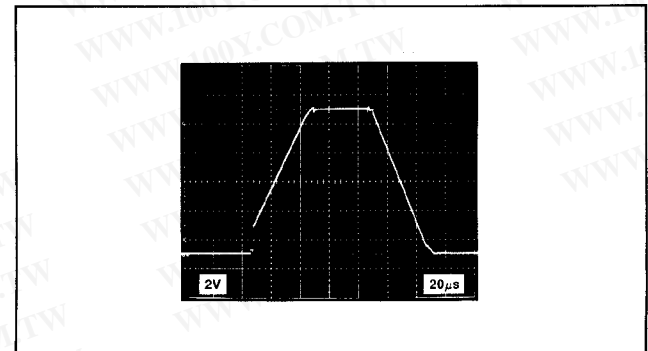

FIGURE 5: Unity-gain Follower

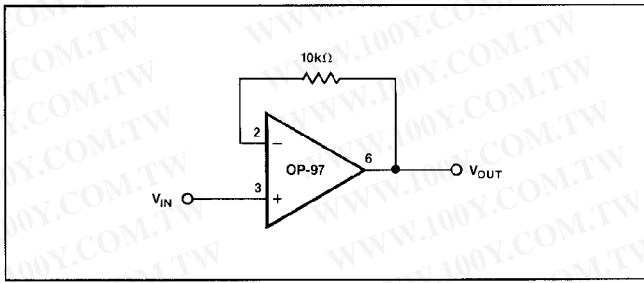
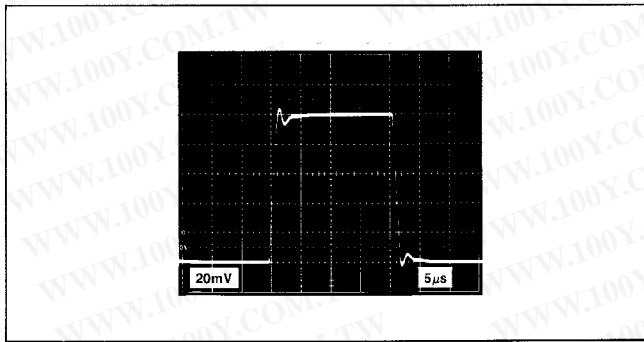

FIGURE 6: Small Signal Transient Response with Overcompensation ($C_{LOAD} = 1000\text{pF}$, $A_{VCL} = +1$, $C_{OC} = 220\text{pF}$)



GUARDING AND SHIELDING

To maintain the extremely high input impedances of the OP-97, care must be taken in circuit board layout and manufacturing. Board surfaces must be kept scrupulously clean and free of moisture. Conformal coating is recommended to provide a humidity barrier. Even a clean PC board can have 100pA of leakage currents between adjacent traces, so that guard rings

should be used around the inputs. Guard traces are operated at a voltage close to that on the inputs, so that leakage currents become minimal. In noninverting applications, the guard ring should be connected to the common-mode voltage at the inverting input (pin 2). In inverting applications, both inputs remain at ground, so that the guard trace should be grounded. Guard traces should be made on both sides of the circuit board.

FIGURE 8: DAC Output Amplifier

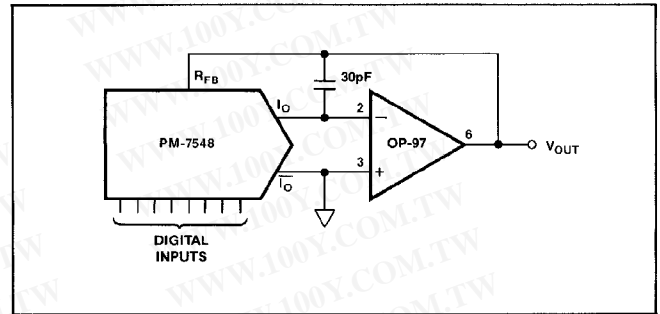

FIGURE 9: Current Monitor

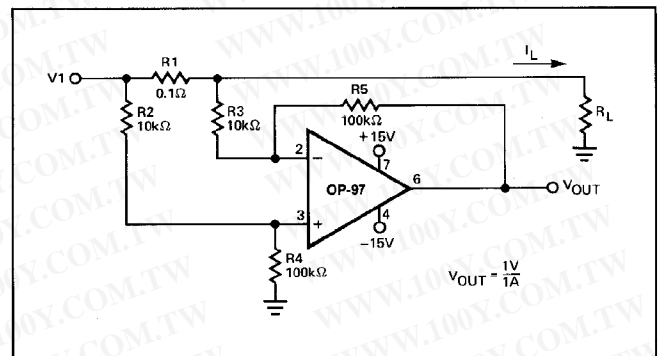

FIGURE 7: Guard Ring Layout and Connections

