

Reflective Object Sensor

OPB608A, OPB608B, OPB608C, OPB608R, OPB608V



Features:

- Phototransistor output
- Unfocused for sensing diffuse surface
- Low cost plastic housing
- Enhanced signal to noise ratio
- Reduced ambient light sensitivity

勝特力材料 886-3-5753170
 勝特力电子(上海) 86-21-54151736
 勝特力电子(深圳) 86-755-83298787
[Http://www.100y.com.tw](http://www.100y.com.tw)



Description:

OPB608 reflective switches consist of an infrared emitting device (LED or VCSEL) and a NPN silicon phototransistor mounted "side-by-side" on a parallel axis in a black opaque plastic housing. All OPB608's (**except OPB608R**) have an emitting device and a phototransistor that are encapsulated in a visible filtering epoxy. The phototransistor responds to radiation from the emitter only when a reflective object passes within its field of view. The phototransistor has enhanced low current roll-off to improve the contrast ratio and immunity to background irradiance. LED versions are designed for near-field applications. The VCSEL version is designed for longer distances.

OPB608A, OPB608B and **OPB608C** devices are designed for applications with reflective distances between 0.050" (1.270 mm) and 0.375" (9.525 mm). **OPB608V** is designed for applications with reflective distances between 0.050" (1.270 mm) and 1.500" (38.100 mm). All of these are designed for light patterns not visible to the human eye. By utilizing the night enhancement function of a camera, the near infrared light pattern can be seen. This allows a user to see the pattern shining on the reflective object.

OPB608R is designed for applications with reflective distances between 0.050" (1.270 mm) and 0.300" (7.620 mm). It is designed for light patterns visible to the human eye. The efficiency of this sensor is lower for optical wavelengths in the visible range, thus reducing the distance that can be used.

Reflective distances are dependent upon the drive current for the light emitting device, the wavelength of the light source, and the type of reflective material; therefore, each application should be checked for the ability to meet each requirement.

Custom electrical, wire and cabling and connectors are available. Contact your local representative or OPTEK for more information.

Applications:

- Non-contact reflective object sensor
- Assembly line automation
- Machine automation
- Machine safety
- End of travel sensor
- Door sensor

Ordering Information

Part Number	LED Peak Wavelength	Sensor	Reflection Distance Inch (mm)	Lead Length
OPB608A	890 nm	Rbe Transistor	See Graph on Page 4	0.18" (Min)
OPB608B				
OPB608C				
OPB608R				
OPB608V				



RoHS

OPTEK reserves the right to make changes at any time in order to improve design and to supply the best product possible.



Additional laser safety information can be found on the Optek website. See application #221. Classification is not marked on the device due to space limitations. See package outline for centerline of optical radiance. Operating devices beyond maximum rating may cause devices to exceed rated classification

Reflective Object Sensor

OPB608A, OPB608B, OPB608C, OPB608R, OPB608V



Absolute Maximum Ratings ($T_A=25^\circ\text{C}$ unless otherwise noted)

Storage Temperature Range		-40° C to +85° C
Operating Temperature Range	OPB608 A, B, C & R OPB608V	-40° C to +85° C 0° C to +70° C
Lead Soldering Temperature [1/16 inch (1.6mm) from the case for 5 sec. with soldering iron] ⁽¹⁾		260° C
Total Power Dissipation		100 mW

OPB608A, OPB608B, OPB608C (Infrared-LED — 890 nm)

Forward DC Current		50 mA
Peak Forward Current (1 μs pulse width, 300 pps)		3 A
Reverse DC Voltage		2 V

OPB608R (Visible Red-LED — 650 nm)

Forward DC Current		50 mA
Reverse DC Voltage		5 V

OPB608V (Infrared-VCSEL — 850 nm)

Forward DC Current		12 mA
Reverse DC Voltage		5 V

Phototransistor

Collector-Emitter Voltage		30 V
Emitter Reverse Current		10 mA
Collector DC Current		25 mA

Notes:

- (1) RMA flux is recommended. Duration can be extended to 10 seconds maximum when flow soldering.
- (2) Methanol or isopropanol are recommended as cleaning agents. The plastic housing is soluble in chlorinated hydrocarbons and keytones.

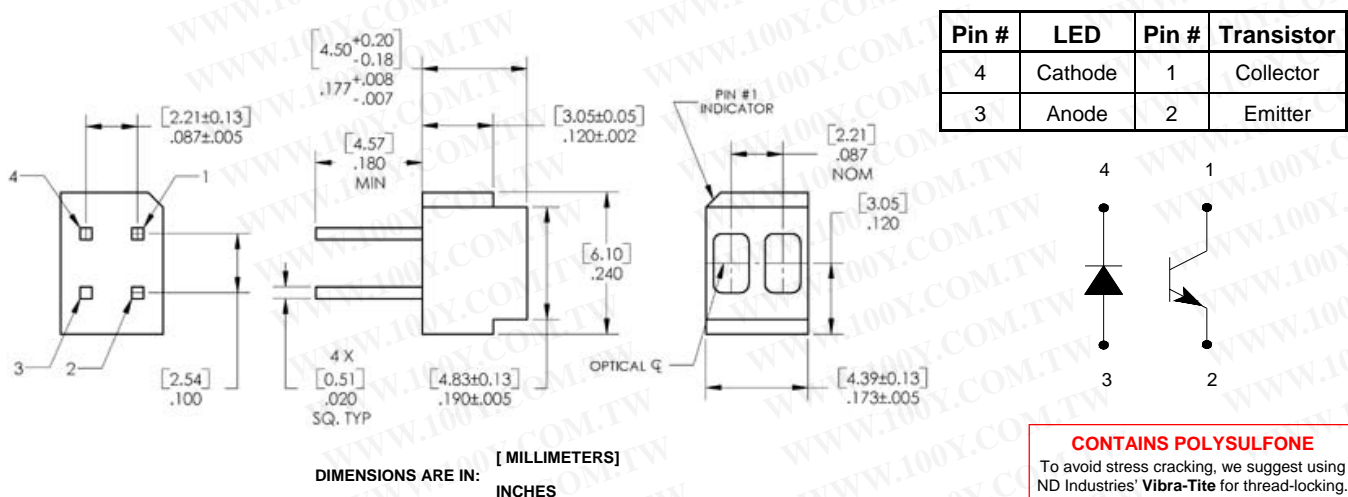

OPTEK reserves the right to make changes at any time in order to improve design and to supply the best product possible.

Electrical Characteristics ($T_A = 25^\circ\text{C}$ unless otherwise noted)

SYMBOL	PARAMETER	MIN	TYP	MAX	UNITS	TEST CONDITIONS
--------	-----------	-----	-----	-----	-------	-----------------

Infrared-LED (880 nm) (See OP240 for additional information)

V_F	Forward Voltage	-	-	1.7	V	$I_F = 20\text{ mA}$
I_R	Reverse Current	-	-	100	μA	$V_R = 2\text{ V}$

Infrared-LED (650 nm)

V_F	Forward Voltage	-	1.9	2.5	V	$I_F = 20\text{ mA}$
V_R	Reverse Voltage	5	-	-	V	$I_R = 10\ \mu\text{A}$

Infrared VCSEL (850 nm) (See OPV330 for additional information)

V_F	Forward Voltage	-	-	2.2	V	$I_F = 12\text{ mA}$
I_R	Reverse Current	-	-	30	nA	$V_R = 5\text{ V}$
I_{TH}	Threshold Current	2	-	5.5	mA	-
Θ	Beam Divergence	-	12	-	Deg.	$I_F = 12\text{ mA}$

Phototransistor (See OP705 for additional information)

$V_{(BR)CEO}$	Collector Emitter Breakdown Voltage	30	-	-	V	$I_C = 100\ \mu\text{A}$, $E_E = 0\ \mu\text{W}/\text{cm}^2$
$V_{(BR)ECO}$	Emitter Collector Breakdown Voltage	4	-	-	V	$I_E = 100\ \mu\text{A}$, $E_E = 0\ \mu\text{W}/\text{cm}^2$
$V_{CE(SAT)}$	Saturation Voltage	-	-	.40	V	$I_C = 100\ \mu\text{A}$, $I_F = 20\text{ mA}$, $d = 0.053''$
I_{CEO}	Collector Emitter Dark Current	-	-	100	nA	$V_{CE} = 5\text{ V}$, $E_E = \leq .10\ \mu\text{W}/\text{cm}^2$, $I_F = 0$

Combined

$I_{C(ON)}$	On-State Collector Current OPB608A OPB608B OPB608C OPB608R	2 1 0.5 1	- - - -	- 4 - 6	mA	$V_{CE} = 5\text{ V}$, $I_F = 20\text{ mA}$, $d = 0.053\text{ inch}$ (2.79 mm) ⁽¹⁾⁽²⁾
	OPB608V	5	-	-		
$I_{C(OFF)}$	Off-State Collector Current LED VCSEL	- -	- -	100 100	nA	No reflective surface, $V_{CE} = 5\text{ V}$ $I_F = 20\text{ mA}$ $I_F = 10\text{ mA}$

Notes:

- (1) Distance from the front of the lens to reflective surface.
- (2) Measured using Eastman Kodak gray card. The white side of the card is used as a 90% diffuse reflective surface. Reference Eastman Kodak catalog #E152 7795
- (3) All parameters are tested using pulse techniques.

勝特力材料 886-3-5753170
勝特力电子(上海) 86-21-54151736
勝特力电子(深圳) 86-755-83298787
[Http://www.100y.com.tw](http://www.100y.com.tw)

OPTEK reserves the right to make changes at any time in order to improve design and to supply the best product possible.

Kodak 90% Card Normalized Output vs Object Distance

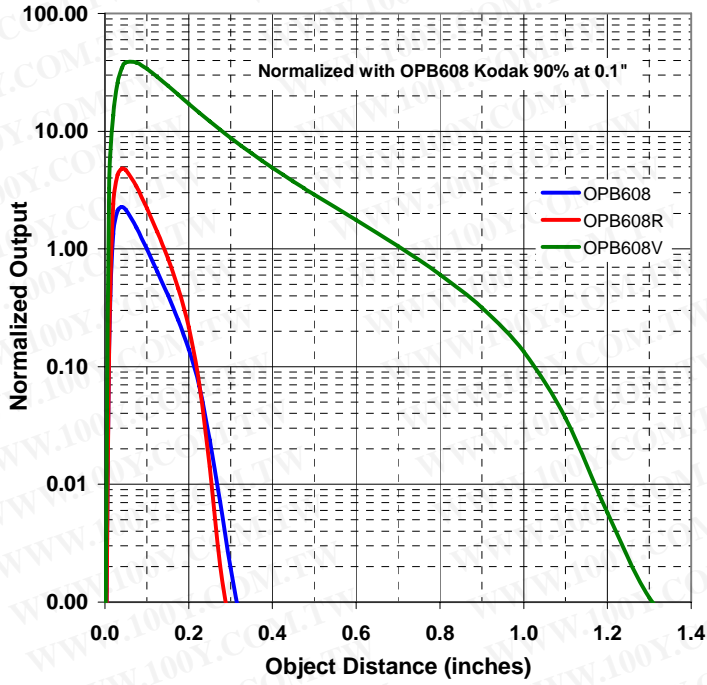

Collector Current vs Diode Forward Current

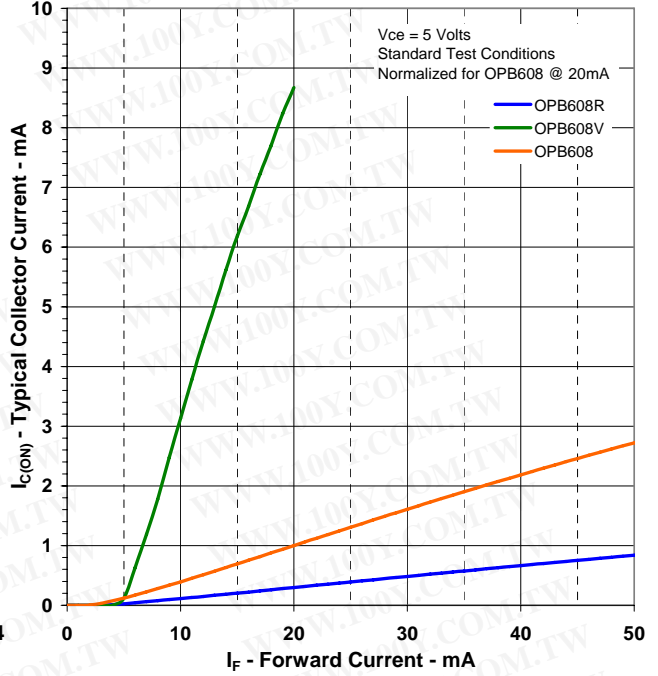

Rise and Fall vs Load Resistance

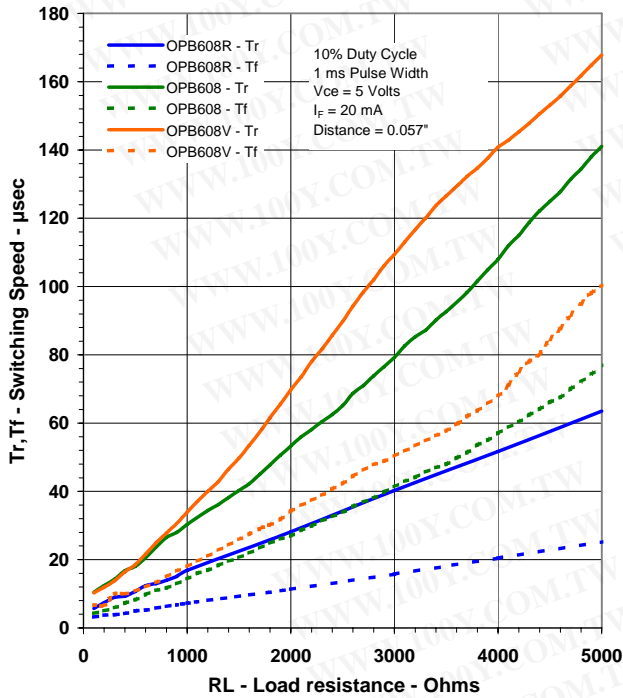

Collector Current vs Ambient Temp.

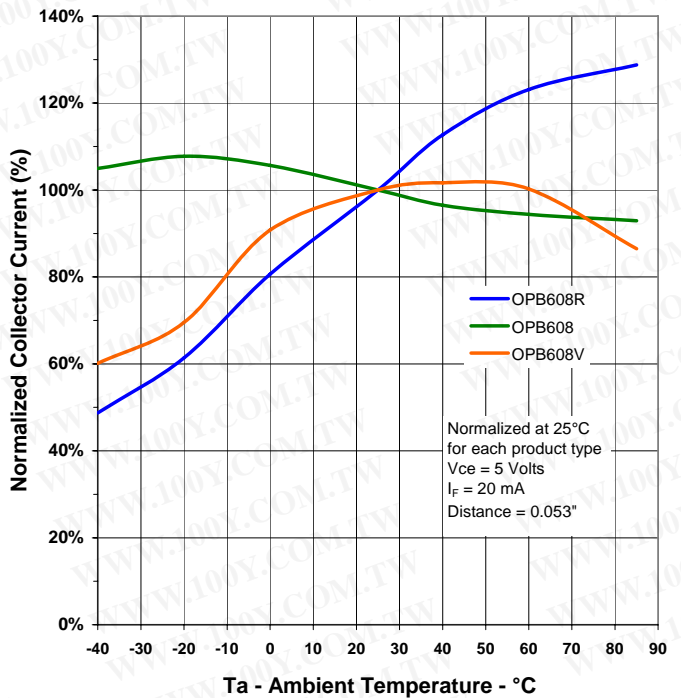

OPTEK reserves the right to make changes at any time in order to improve design and to supply the best product possible.

Reflective Response

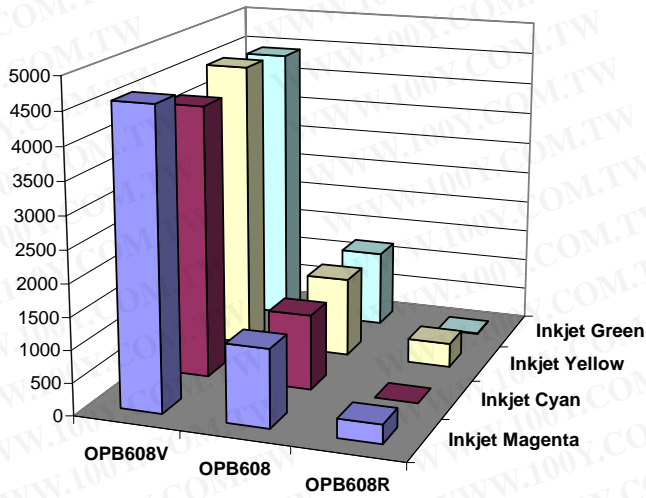

Reflective Response

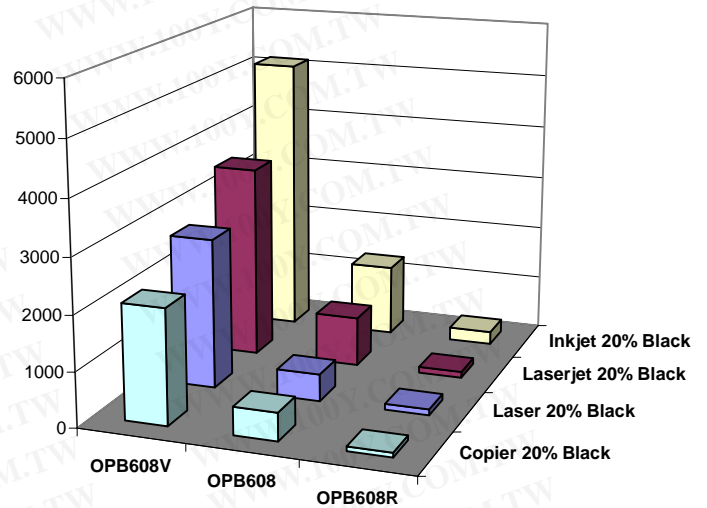

Reflective Response

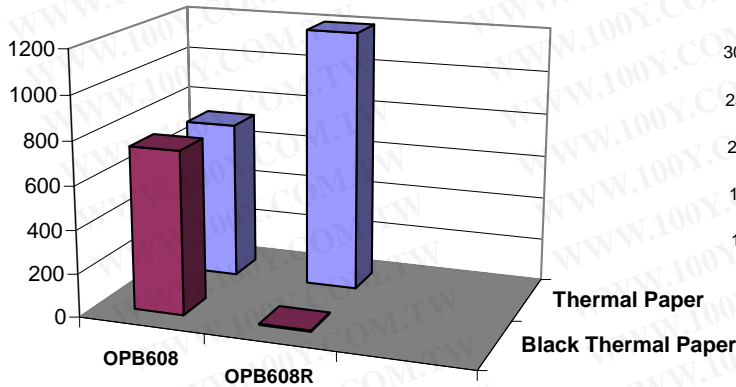

Reflective Response

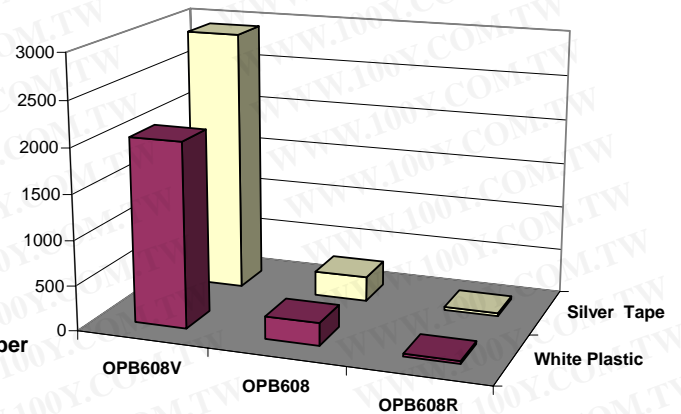

Reflective Response

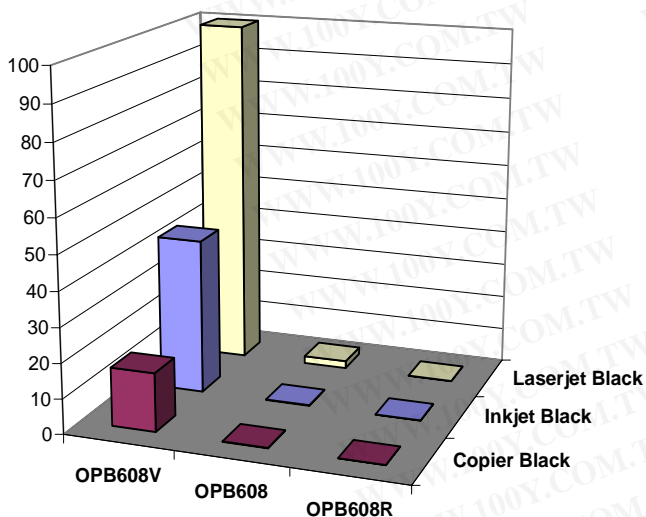

Relative Response

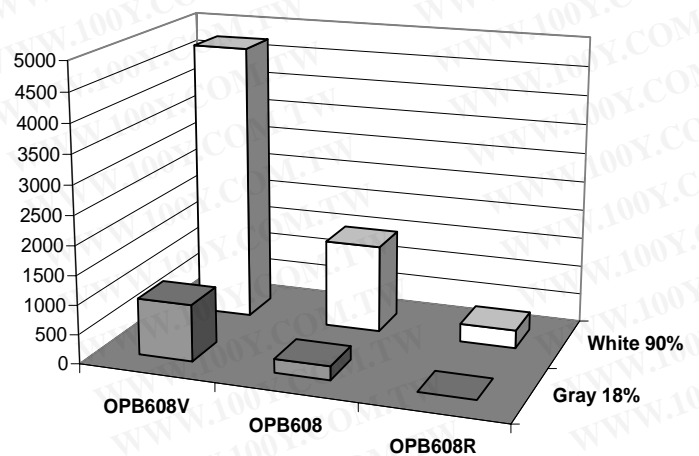

OPTEK reserves the right to make changes at any time in order to improve design and to supply the best product possible.