

Bushless version

## FEATURES

- Carbon resistive element
- Dust proof enclosure
- Polyester substrate
- Modular gang type (up to 4)
- Self extinguishable material UL 94-V0
- Upon request:
  - Metallic support
  - Stereo matching
  - Switch
  - Nut & washer
  - Bushless option available

## MECHANICAL SPECIFICATIONS

- Mechanical rotation angle:  $300^\circ \pm 5^\circ$
- Electrical rotation angle:  $280^\circ \pm 20^\circ$
- Torque: 0.5 to 1.5 Ncm. (0.7 to 2.1 in-oz)
- Stop torque:  $> 40$  Ncm. ( $>56$  in-oz)
- Max. torque nut (binding out):  $< 80$  Ncm. (112 in-oz)
- Thrust and pull in the shaft:  $> 25$  N

勝特力材料 886-3-5753170  
 勝特力电子(上海) 86-21-54151736  
 勝特力电子(深圳) 86-755-83298787  
[Http://www.100y.com.tw](http://www.100y.com.tw)

## ELECTRICAL SPECIFICATIONS

- Range of values (\*):  $100\Omega \leq R_n \leq 5\text{ M}$  (Decad. 1.0 - 2.0 - 2.2 - 2.5 - 4.7 - 5.0)
  - Tolerance (\*):  $100\Omega \leq R_n \leq 1\text{M}\Omega$  .....  $\pm 20\%$   
 $1\text{M}\Omega < R_n \leq 5\text{M}\Omega$  .....  $\pm 30\%$
  - Max. Voltage: 250 VDC (lin) 125 VDC (no lin)
  - Nominal Power  $50^\circ\text{C}$  ( $122^\circ\text{F}$ ) (see power rating curve)  
 $0.2\text{ W}$  (lin)  $0.1\text{ W}$  (no lin)
  - Taper (\*): (Log. & Alog. only  $R_n > 1\text{K}$ ) Lin ; Log; Alog.
  - Residual resistance:  $\leq 0.1\%$   $R_n$  ( $2\Omega$  min.)
  - Equivalent Noise Resistance:  $\leq 3\%$   $R_n$  ( $3\Omega$  min.)
  - Operating temperature\*\*:  $-25^\circ\text{C} + 70^\circ\text{C}$  ( $-13^\circ\text{F} + 158^\circ\text{F}$ )
- \* Others upon request      \*\* Up to  $85^\circ\text{C}$  depending on application

## HOW TO ORDER

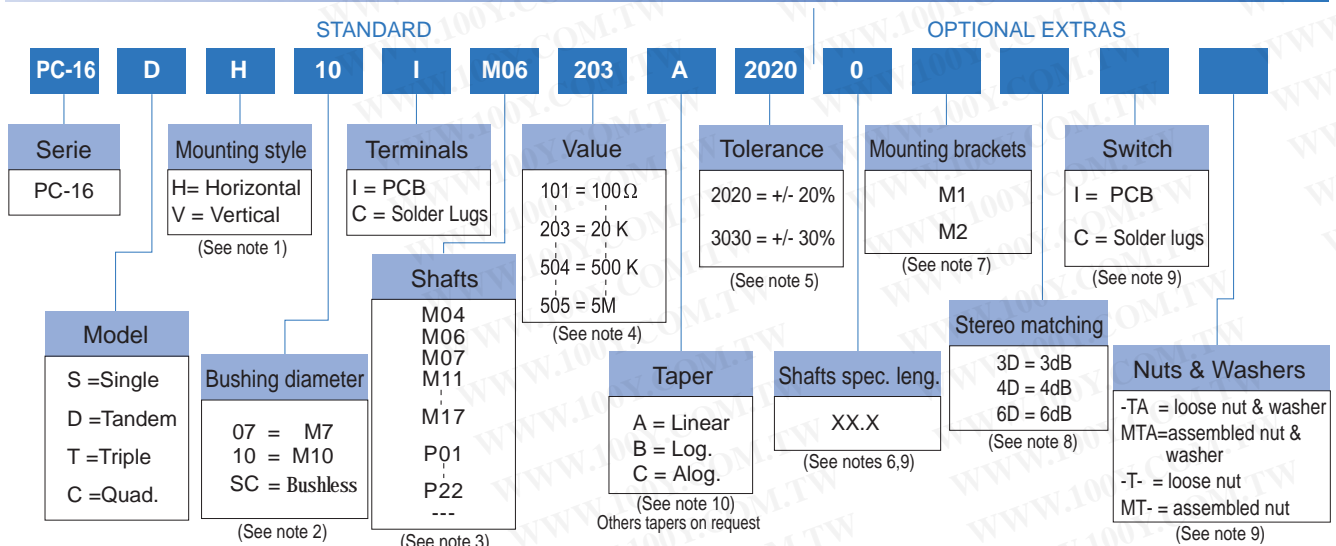

### NOTES:

- (1) Mounting style: Type "V" is only available in model "S" potentiometer and with printed circuit terminals.
- (2) Bushings: Type "10" has two parallel flat surfaces for avoiding rotation. Bushless option only available for single model.
- (3) M07 shaft is only available with M10 bushing. --- = no shaft
- (4) Value:
  - Code:  $10 \quad 1 \quad 100\Omega$ 
    - Number of zeros
    - 2 first digits of the value.
  - In models "D", "T", "C", with different values, they will be asked by drawings.
- (5) Tolerance (non standard), upon request. Example:  $+7\%$  Code:  $07 \quad 05$ 
  - negative tolerance
  - positive tolerance
- (6) Shaft special length:
  - Only for special length and plain shafts (not knurled). Example: Shaft  $\varnothing 6.35$  L= 24.5
  - NOTE: Maximum length recommended: L = 45
- (7) Mounting brackets: Only applicable for model "S", mounting "H" and without switch.
- (8) Stereo matching: not available for single models. Maximum will be: •3dB for model "D" •4dB for model "T" •6dB for model "C"
- (9) Not available for Bushless version.
- (10) Switch option not available with antilog taper.

NOTE: The information contained here should be used for reference purposes only.

## HOW TO ORDER CUSTOM DRAWING

PC-16 S V + DRAWING NUMBER (Max. 16 digits)

This way of ordering should be used for options which are not included in the "How to order" standard and optional extras.

## STANDARD OPTIONS

Shaft length ..... 0 Standard Length  
 Mounting brackets ..... Without mounting brackets  
 Stereo matching ..... Only on request (see note 8)  
 Switch ..... No switch  
 Nut & washer ..... Without nut and washer

## MODELS

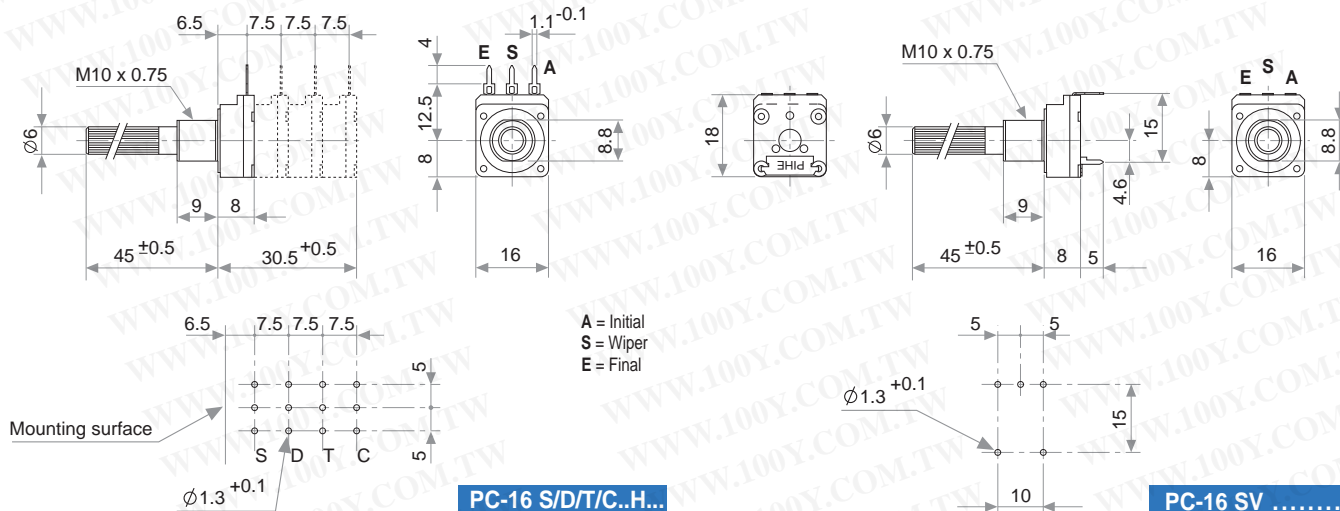

## METALLIC SUPPORT

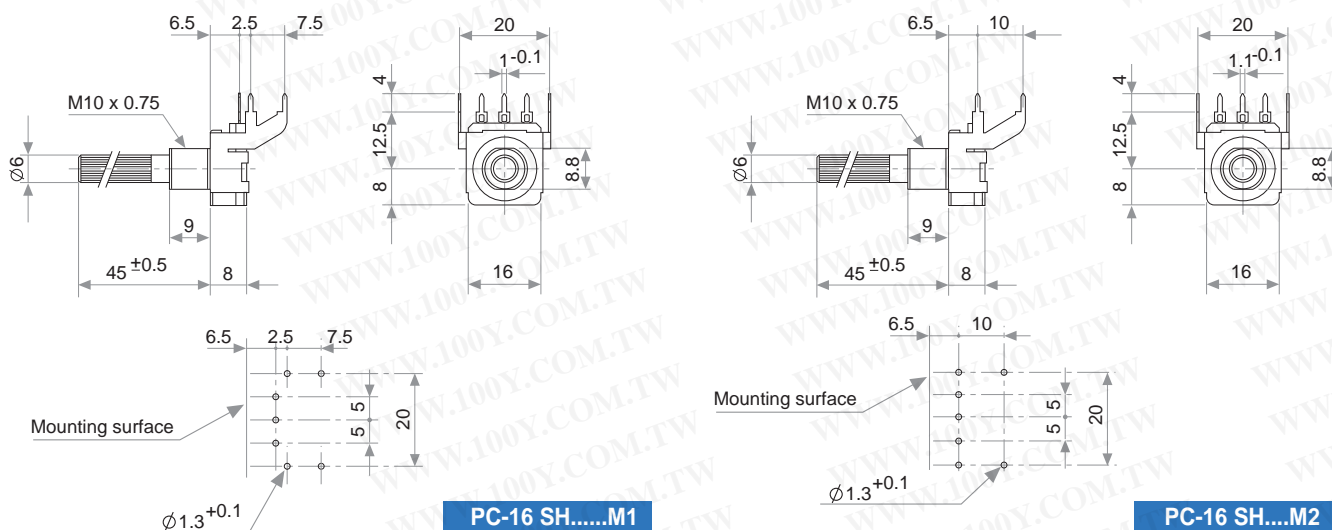

## BUSHINGS

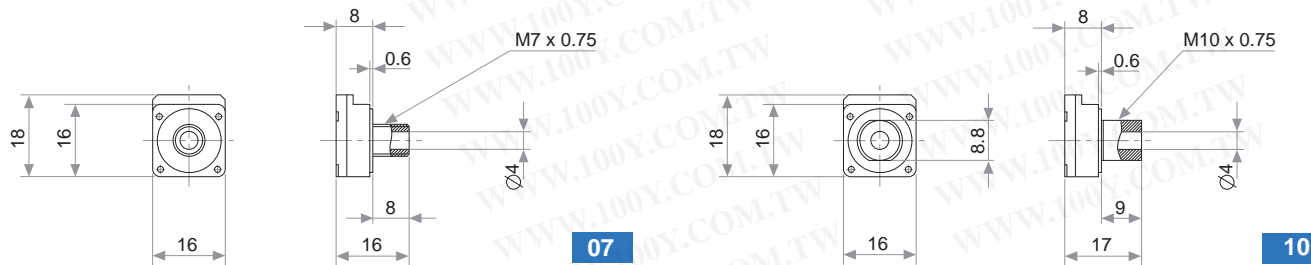

## EXAMPLES OF BUSHLESS VERSION

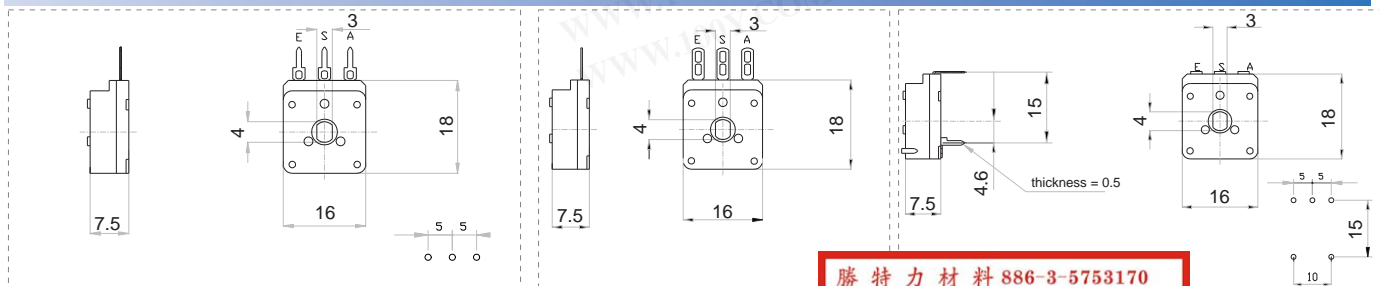

勝特力材料 886-3-5753170  
 勝特力电子(上海) 86-21-54151736  
 勝特力电子(深圳) 86-755-83298787  
[Http://www.100y.com.tw](http://www.100y.com.tw)



## TERMINALS

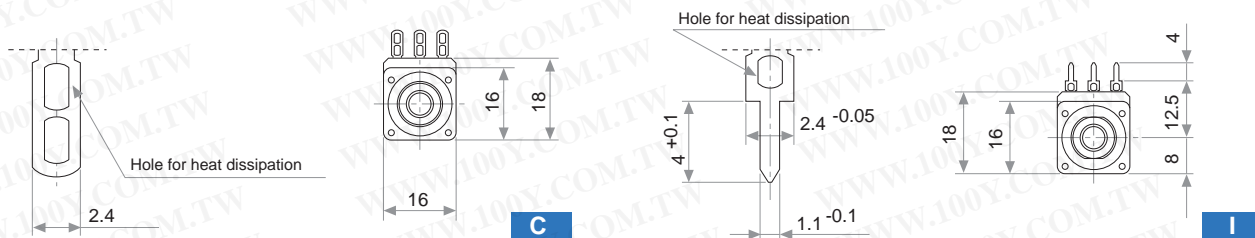

## TAPERS

Standard

A = Linear  
B = Log.  
C = Alog.

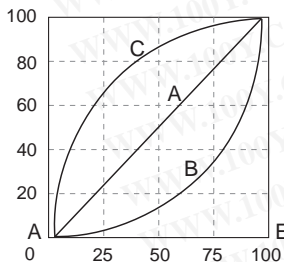

## POWER RATING CURVE

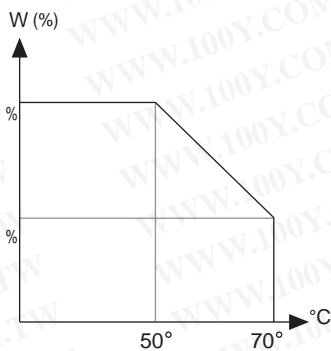

## NUTS & WASHERS

Bushing 10

Bushing 07

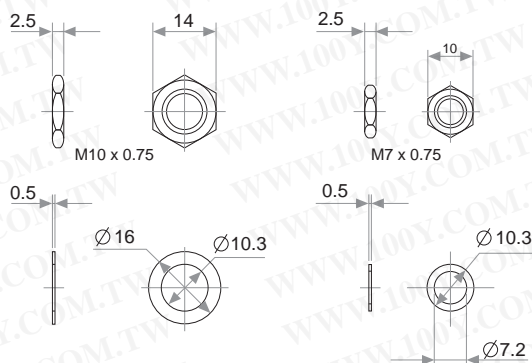

NOTE = Please note relative terminal positions when ordering non linear tapers.

## TESTS

## TYPICAL VARIATIONS

TESTS		TYPICAL VARIATIONS
ELECTRICAL LIFE	1.000 h. @ 50°C; 0.2 W	±5 %
MECHANICAL LIFE : POT. SWITCH	25.000 (10-15 CPM) 10.000 (1 A, 50 VAC)	±3 % (Rn < 1 MΩ)
TEMPERATURE COEFFICIENT	-25°C; +70°C	±300 ppm/°C (Rn < 100 KΩ)
THERMAL CYCLING	16 h. @ 85°C; 2h. @ -25°C	±2.5 %
DAMP HEAT	500 h. @ 40°C @ 95% HR	±5 %
VIBRATION (for each plane X,Y,Z)	2 h. @ 10 Hz. ... 55 Hz.	±2 %

## SWITCH

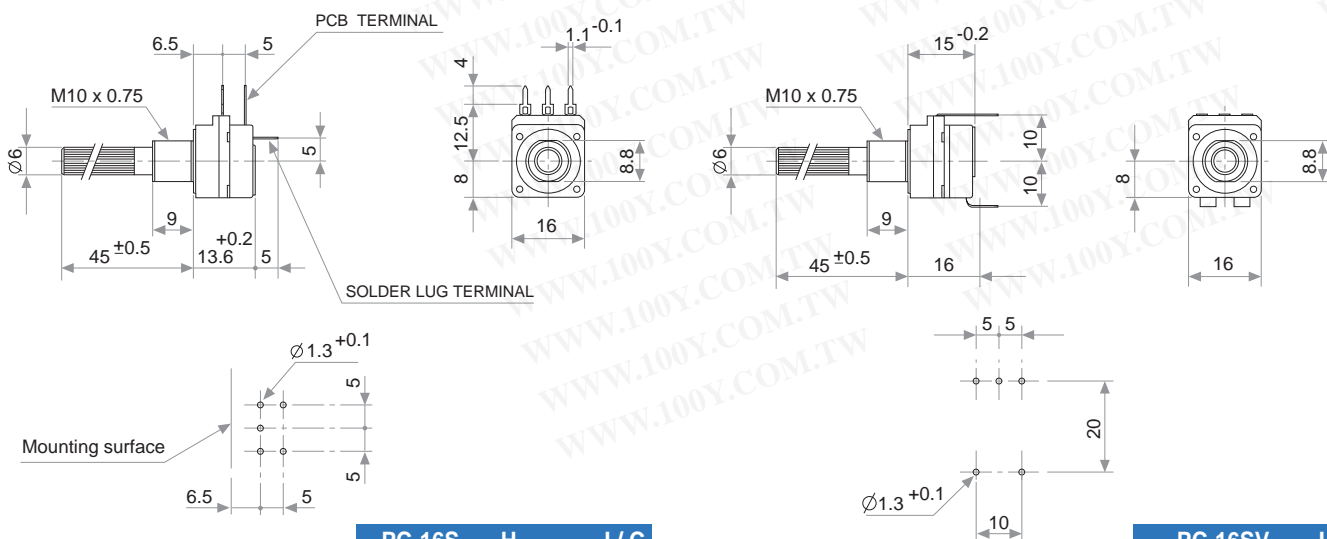

PC-16S ... H ... I / C

PC-16SV ... I

勝特力材料 886-3-5753170  
勝特力电子(上海) 86-21-54151736  
勝特力电子(深圳) 86-755-83298787  
[Http://www.100y.com.tw](http://www.100y.com.tw)

## SWITCH SPECIFICATIONS

NOMINAL CURRENT	1A, 250 VAC
CONTACT RESISTANCE (initial)	10 m $\Omega$
OPERATING TORQUE	1 to 3 Ncm (1.4 to 4.2 in oz)
OPERATING ANGLE	30° $\pm$ 5°
TEST VOLTAGE	500 V

## PACKAGING

Boxes of 50 pieces (160 x 110 x 85 mm.)

勝特力材料 886-3-5753170  
 勝特力电子(上海) 86-21-54151736  
 勝特力电子(深圳) 86-755-83298787  
[Http://www.100y.com.tw](http://www.100y.com.tw)

## METALIC SHAFTS

### STANDARD

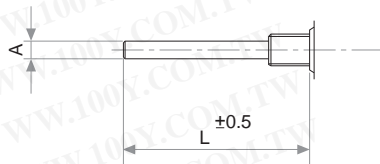

A	L	CODE
4	45	M04
6	45	M06
6.35	45	M07

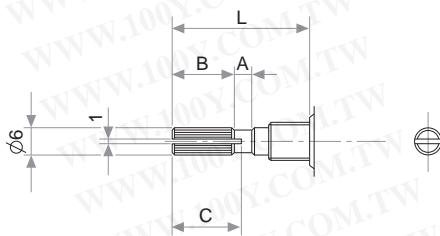

A	B	C	L	CODE
2	5	7	15	M11
2	10	11	20	M12
4	12	14	25	M13
4	12	14	30	M14
4	12	14	35	M15
4	12	14	40	M16
4	12	14	45	M17

### SPECIAL

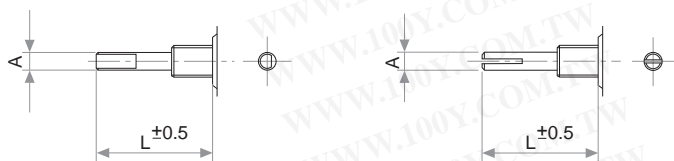

A
4
6
6.35

## PLASTIC SHAFTS Ø4

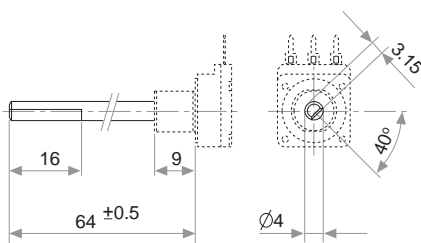

P01

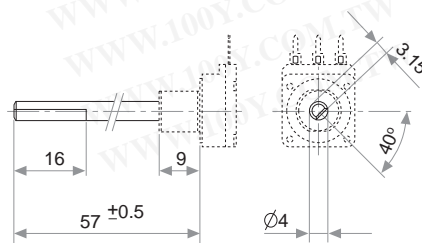

P02

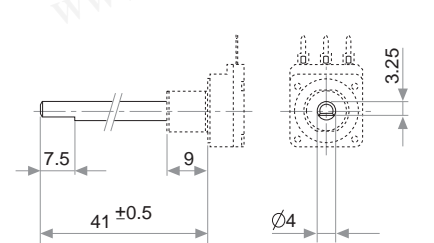

P03

## PLASTIC SHAFTS Ø4

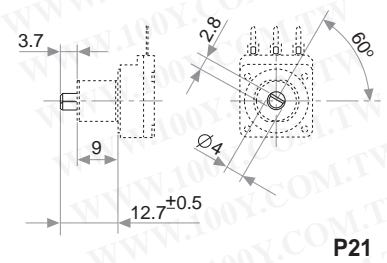
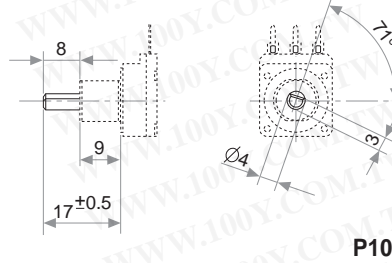
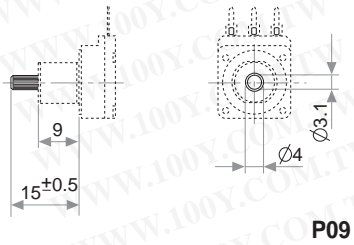
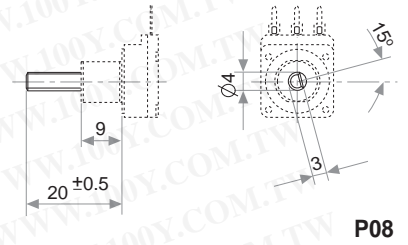
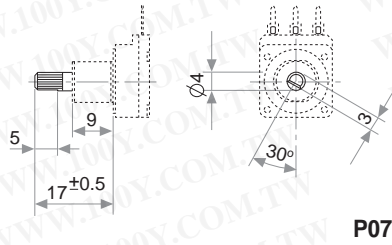
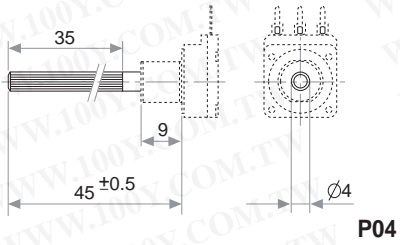

## PLASTIC SHAFTS Ø6

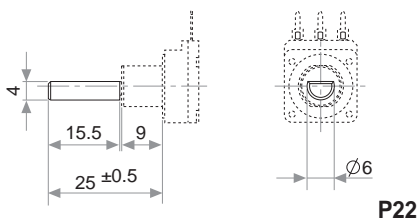
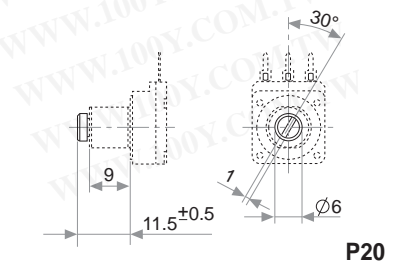
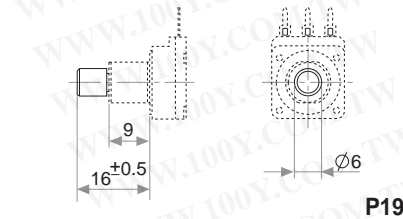
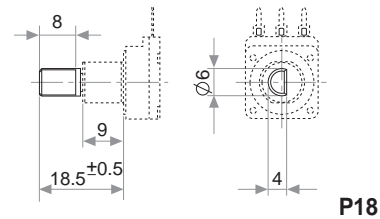
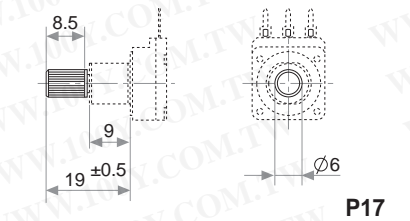
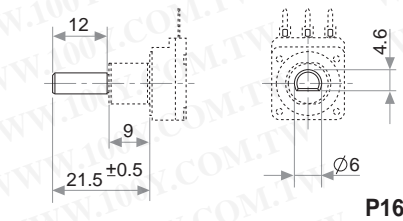
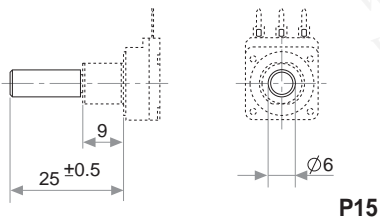
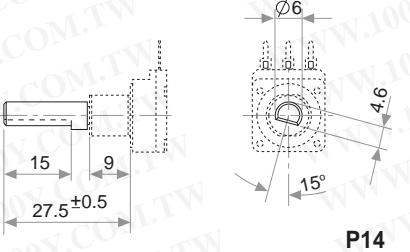
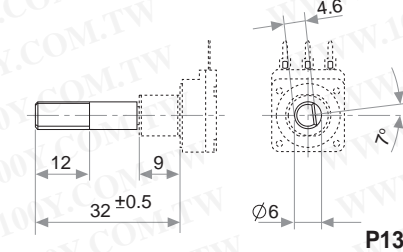
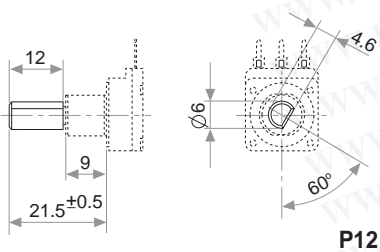
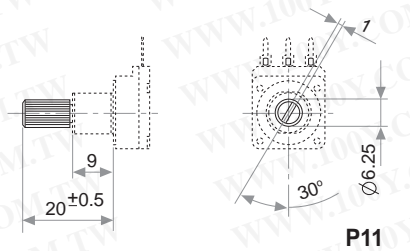
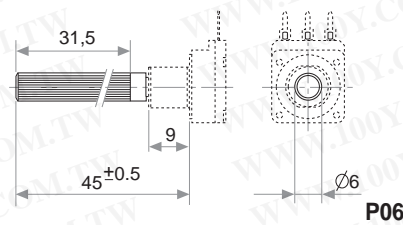
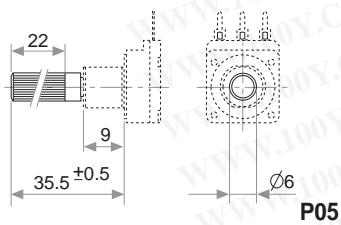

NOTE: Shaft position shown full CCW. Any other position for plastic shafts has to be shifted n times 24°  
Other positions upon request.

勝特力材料 886-3-5753170  
 勝特力电子(上海) 86-21-54151736  
 勝特力电子(深圳) 86-755-83298787  
[Http://www.100y.com.tw](http://www.100y.com.tw)