

DATA SHEET

勝特力材料 886-3-5753170
勝特力电子(上海) 86-21-54151736
勝特力电子(深圳) 86-755-83298787
[Http://www.100y.com.tw](http://www.100y.com.tw)

74HC1G14; 74HCT1G14 Inverting Schmitt-trigger

Product specification
File under Integrated Circuits, IC06

1998 Aug 05

Inverting Schmitt-trigger

74HC1G14; 74HCT1G14

FEATURES

- Wide operating voltage range: 2.0 to 6.0 V
- Symmetrical output impedance
- High noise immunity
- Low power dissipation
- Balanced propagation delays
- Very small 5 pins package
- Applications
 - Wave and pulse shapers
 - Astable multivibrators
 - Monostable multivibrators
- Output capability: standard.

DESCRIPTION

The 74HC1G/HCT1G14 is a high-speed Si-gate CMOS device.

The 74HC1G/HCT1G14 provides the inverting buffer function with Schmitt-trigger action. These devices are capable of transforming slowly changing input signals into sharply defined, jitter-free output signals.

The standard output currents are $\frac{1}{2}$ compared to the 74HC/HCT14.

FUNCTION TABLE

See note 1.

INPUT inA	OUTPUT outY
L	H
H	L

Note

1. H = HIGH voltage level;
L = LOW voltage level.

QUICK REFERENCE DATA

GND = 0 V; $T_{amb} = 25\text{ }^{\circ}\text{C}$; $t_r = t_f = 6.0\text{ ns}$.

SYMBOL	PARAMETER	CONDITIONS	TYP.		UNIT
			HC1G	HCT1G	
t_{PHL}/t_{PLH}	propagation delay inA to outY	$C_L = 15\text{ pF}$ $V_{CC} = 5\text{ V}$	10	15	ns
C_I	input capacitance		1.5	1.5	pF
C_{PD}	power dissipation capacitance	notes 1 and 2	20	22	pF

Notes

1. C_{PD} is used to determine the dynamic power dissipation (P_D in μW).
 $P_D = C_{PD} \times V_{CC}^2 \times f_i + \sum (C_L \times V_{CC}^2 \times f_o)$ where:
 f_i = input frequency in MHz;
 f_o = output frequency in MHz;
 C_L = output load capacitance in pF;
 V_{CC} = supply voltage in V;
 $\sum (C_L \times V_{CC}^2 \times f_o)$ = sum of outputs.
2. For HC1G the condition is $V_I = \text{GND to } V_{CC}$.
 For HCT1G the condition is $V_I = \text{GND to } V_{CC} - 1.5\text{ V}$.

PINNING

PIN	SYMBOL	DESCRIPTION
1	n.c.	not connected
2	inA	data input
3	GND	ground (0 V)
4	outY	data output
5	V_{CC}	DC supply voltage

勝特力材料 886-3-5753170
 勝特力电子(上海) 86-21-54151736
 勝特力电子(深圳) 86-755-83298787
[Http://www.100y.com.tw](http://www.100y.com.tw)

Inverting Schmitt-trigger

74HC1G14; 74HCT1G14

ORDERING AND PACKAGE INFORMATION

OUTSIDE NORTH AMERICA	PACKAGES					
	TEMPERATURE RANGE	PINS	PACKAGE	MATERIAL	CODE	MARKING
74HC1G14GW	-40 to +125 °C	5	SC-88A	plastic	SOT353	HF
74HCT1G14GW		5	SC-88A	plastic	SOT353	TF

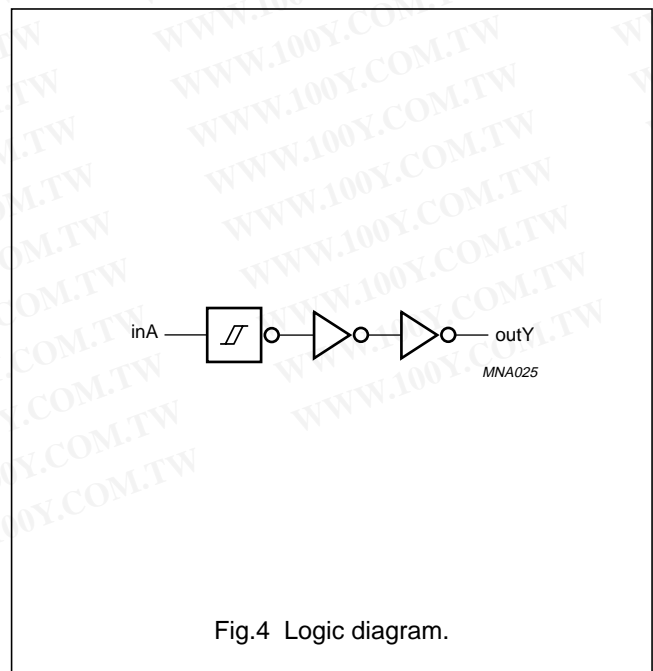
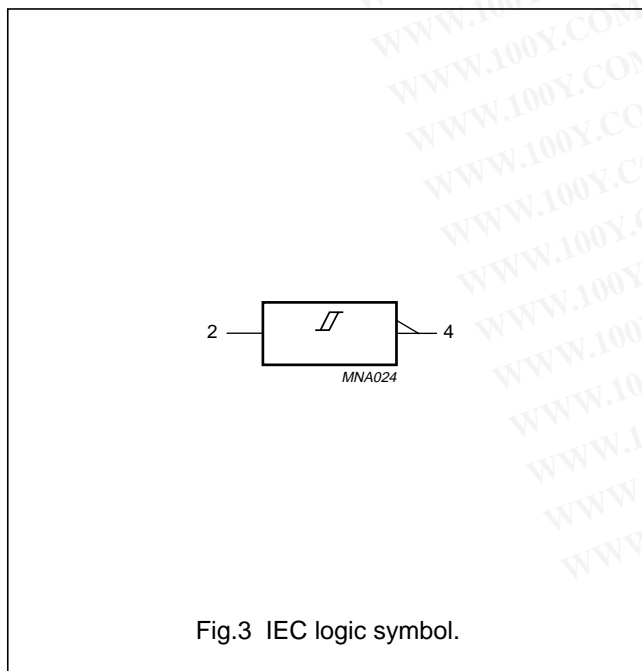
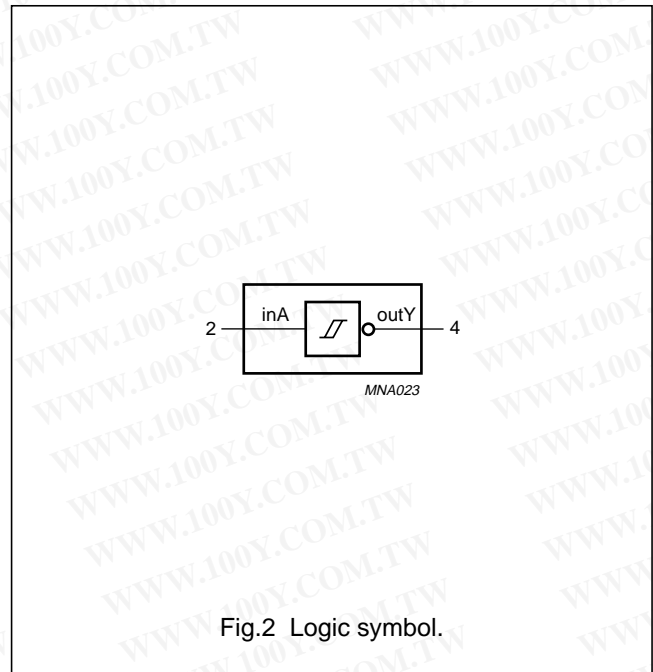
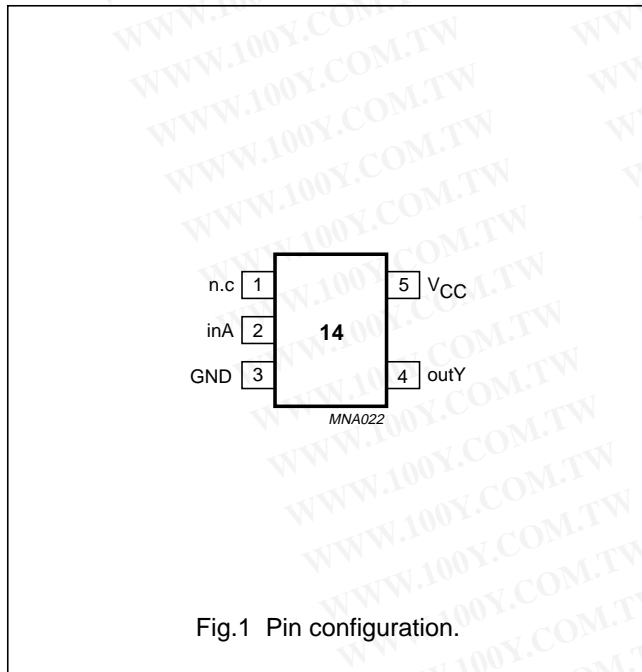

Inverting Schmitt-trigger

74HC1G14; 74HCT1G14

RECOMMENDED OPERATING CONDITIONS

SYMBOL	PARAMETER	74HC1G			74HCT1G			UNIT	CONDITIONS
		MIN.	TYP.	MAX.	MIN.	TYP.	MAX.		
V _{CC}	DC supply voltage	2.0	5.0	6.0	4.5	5.0	5.5	V	
V _I	input voltage	0	–	V _{CC}	0	–	V _{CC}	V	
V _O	output voltage	0	–	V _{CC}	0	–	V _{CC}	V	
T _{amb}	operating ambient temperature range	–40	+25	+125	–40	+25	+125	°C	see DC and AC characteristics per device

LIMITING VALUES

In accordance with the Absolute Maximum Rating System (IEC 134); voltages are referenced to GND (ground = 0 V).

SYMBOL	PARAMETER	CONDITIONS	MIN.	MAX.	UNIT
V _{CC}	DC supply voltage		–0.5	+7.0	V
±I _{IK}	DC input diode current	V _I < –0.5 V or V _I > V _{CC} + 0.5 V; note 1	–	20	mA
±I _{OK}	DC output diode current	V _O < –0.5 V or V _O > V _{CC} + 0.5 V; note 1	–	20	mA
±I _O	DC output source or sink current standard outputs	–0.5 V < V _O < V _{CC} + 0.5 V; note 1	–	12.5	mA
±I _{CC}	DC V _{CC} or GND current for types with standard outputs	note 1	–	25	mA
T _{stg}	storage temperature range		–65	+150	°C
P _D	power dissipation per package 5 pins plastic SC-88A	for temperature range: –40 to +125 °C above +55 °C derate linearly with 2.5 mW/K	–	200	mW

Note

- The input and output voltage ratings may be exceeded if the input and output current ratings are observed.

勝特力材料 886-3-5753170
 勝特力电子(上海) 86-21-54151736
 勝特力电子(深圳) 86-755-83298787
[Http://www.100y.com.tw](http://www.100y.com.tw)

Inverting Schmitt-trigger

74HC1G14; 74HCT1G14

DC CHARACTERISTICS FOR THE 74HC1G

Over recommended operating conditions; voltages are referenced to GND (ground = 0 V).

SYMBOL	PARAMETER	T _{amb} (°C)					UNIT	TEST CONDITIONS	
		-40 to +85			-40 to +125			V _{CC} (V)	OTHER
		MIN.	TYP. ⁽¹⁾	MAX.	MIN.	MAX.			
V _{OH}	HIGH-level output voltage; all outputs	1.9	2.0	–	1.9	–	V	2.0	V _I = V _{IH} or V _{IL} ; –I _O = 20 μA
		4.4	4.5	–	4.4	–	V	4.5	
		5.9	6.0	–	5.9	–	V	6.0	
V _{OH}	HIGH-level output voltage; standard outputs	4.13	4.32	–	3.7	–	V	4.5	V _I = V _{IH} or V _{IL} ; –I _O = 2.0 mA
		5.63	5.81	–	5.2	–	V	6.0	V _I = V _{IH} or V _{IL} ; –I _O = 2.6 mA
V _{OL}	LOW-level output voltage; all outputs	–	0	0.1	–	0.1	V	2.0	V _I = V _{IH} or V _{IL} ; I _O = 20 μA
		–	0	0.1	–	0.1	V	4.5	
		–	0	0.1	–	0.1	V	6.0	
V _{OL}	LOW-level output voltage; standard outputs	–	0.15	0.33	–	0.4	V	4.5	V _I = V _{IH} or V _{IL} ; I _O = 2.0 mA
		–	0.16	0.33	–	0.4	V	6.0	V _I = V _{IH} or V _{IL} ; I _O = 2.6 mA
I _I	input leakage current	–	–	1.0	–	1.0	μA	6.0	V _I = V _{CC} or GND
I _{CC}	quiescent supply current	–	–	10	–	20	μA	6.0	V _I = V _{CC} or GND; I _O = 0

Note

1. All typical values are measured at T_{amb} = 25 °C.

DC CHARACTERISTICS FOR THE 74HC1G14

Voltages are referenced to GND (ground = 0 V).

SYMBOL	PARAMETER	T _{amb} (°C)					UNIT	TEST CONDITIONS	
		-40 to +85			-40 to +125			V _{CC} (V)	WAVEFORMS
		MIN.	TYP. ⁽¹⁾	MAX.	MIN.	MAX.			
V _{T+}	positive-going threshold	0.7	1.09	1.5	0.7	1.5	V	2.0	see Figs 5 and 6
		1.7	2.36	3.15	1.7	3.15	V	4.5	
		2.1	3.12	4.2	2.1	4.2	V	6.0	
V _{T-}	negative-going threshold	0.3	0.60	0.9	0.3	0.9	V	2.0	see Figs 5 and 6
		0.9	1.53	2.0	0.9	2.0	V	4.5	
		1.2	2.08	2.6	1.2	2.6	V	6.0	
V _H	hysteresis (V _{T+} – V _{T-})	0.2	0.48	1.0	0.2	1.0	V	2.0	see Figs 5 and 6
		0.4	0.83	1.4	0.4	1.4	V	4.5	
		0.6	1.04	1.6	0.6	1.6	V	6.0	

Note

1. All typical values are measured at T_{amb} = 25 °C.

Inverting Schmitt-trigger

74HC1G14; 74HCT1G14

DC CHARACTERISTICS FOR THE 74HCT1G

Over recommended operating conditions; voltages are referenced to GND (ground = 0 V).

SYMBOL	PARAMETER	T_{amb} (°C)					UNIT	TEST CONDITIONS	
		-40 to +85			-40 to +125			V_{CC} (V)	OTHER
		MIN.	TYP. ⁽¹⁾	MAX.	MIN.	MAX.			
V_{OH}	HIGH-level output voltage; all outputs	4.4	4.5	–	4.4	–	V	4.5	$V_I = V_{IH}$ or V_{IL} ; $-I_O = 20 \mu A$
V_{OH}	HIGH-level output voltage; standard outputs	4.13	4.32	–	3.7	–	V	4.5	$V_I = V_{IH}$ or V_{IL} ; $-I_O = 2.0 \text{ mA}$
V_{OL}	LOW-level output voltage; all outputs	–	0	0.1	–	0.1	V	4.5	$V_I = V_{IH}$ or V_{IL} ; $I_O = 20 \mu A$
V_{OL}	LOW-level output voltage; standard outputs	–	0.15	0.33	–	0.4	V	4.5	$V_I = V_{IH}$ or V_{IL} ; $I_O = 2.0 \text{ mA}$
I_I	input leakage current	–	–	1.0	–	1.0	μA	5.5	$V_I = V_{CC}$ or GND
I_{CC}	quiescent supply current	–	–	10.0	–	20.0	μA	5.5	$V_I = V_{CC}$ or GND; $I_O = 0$
ΔI_{CC}	additional supply current per input	–	–	500	–	850	μA	4.5 to 5.5	$V_I = V_{CC} - 2.1 \text{ V}$; $I_O = 0$

Note1. All typical values are measured at $T_{amb} = 25 \text{ }^\circ\text{C}$.**DC CHARACTERISTICS FOR THE 74HCT1G14**

Voltages are referenced to GND (ground = 0 V).

SYMBOL	PARAMETER	T_{amb} (°C)					UNIT	TEST CONDITIONS	
		-40 to +85			-40 to +125			V_{CC} (V)	WAVEFORMS
		MIN.	TYP. ⁽¹⁾	MAX.	MIN.	MAX.			
V_{T+}	positive-going threshold	1.2	1.55	1.9	1.2	1.9	V	4.5	see Figs 5 and 6
		1.4	1.80	2.1	1.4	2.1	V	5.5	
V_{T-}	negative-going threshold	0.5	0.76	1.2	0.5	1.2	V	4.5	see Figs 5 and 6
		0.6	0.90	1.4	0.6	1.4	V	5.5	
V_H	hysteresis ($V_{T+} - V_{T-}$)	0.4	0.80	–	0.4	–	V	4.5	see Figs 5 and 6
		0.4	0.90	–	0.4	–	V	5.5	

Note1. All typical values are measured at $T_{amb} = 25 \text{ }^\circ\text{C}$.

勝特力材料 886-3-5753170
 勝特力电子(上海) 86-21-54151736
 勝特力电子(深圳) 86-755-83298787
[Http://www.100y.com.tw](http://www.100y.com.tw)

Inverting Schmitt-trigger

74HC1G14; 74HCT1G14

AC CHARACTERISTICS FOR 74HC1G14

GND = 0 V; $t_r = t_f = 6.0$ ns; $C_L = 50$ pF.

SYMBOL	PARAMETER	T_{amb} (°C)					UNIT	TEST CONDITIONS	
		-40 to +85			-40 to +125			V_{CC} (V)	WAVEFORMS
		MIN.	TYP. ⁽¹⁾	MAX.	MIN.	MAX.			
t_{PHL}/t_{PLH}	propagation delay inA to outY	-	25	155	-	190	ns	2.0	see Figs 12 and 13
		-	12	31	-	38	ns	4.5	
		-	11	26	-	32	ns	6.0	

Note

- All typical values are measured at $T_{amb} = 25$ °C.

AC CHARACTERISTICS FOR 74HCT1G14

GND = 0 V; $t_r = t_f = 6.0$ ns; $C_L = 50$ pF.

SYMBOL	PARAMETER	T_{amb} (°C)					UNIT	TEST CONDITIONS	
		-40 to +85			-40 to +125			V_{CC} (V)	WAVEFORMS
		MIN.	TYP. ⁽¹⁾	MAX.	MIN.	MAX.			
t_{PHL}/t_{PLH}	propagation delay inA to outY	-	17	43	-	51	ns	4.5	see Figs 12 and 13

Note

- All typical values are measured at $T_{amb} = 25$ °C.

勝特力材料 886-3-5753170
 勝特力电子(上海) 86-21-54151736
 勝特力电子(深圳) 86-755-83298787
[Http://www.100y.com.tw](http://www.100y.com.tw)

Inverting Schmitt-trigger

74HC1G14; 74HCT1G14

TRANSFER CHARACTERISTIC WAVEFORMS

勝特力材料 886-3-5753170
 勝特力电子(上海) 86-21-54151736
 勝特力电子(深圳) 86-755-83298787
[Http://www.100y.com.tw](http://www.100y.com.tw)

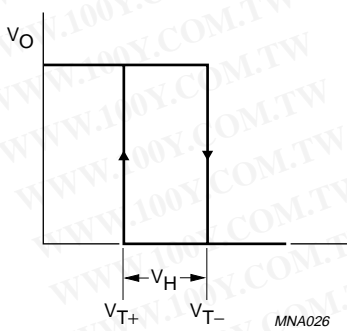

Fig.5 Transfer characteristic.

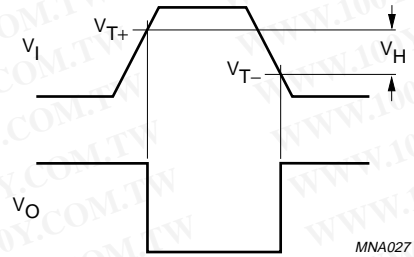

Fig.6 The definitions of V_{T+} , V_{T-} and V_H ; where V_{T+} and V_{T-} are between limits of 20% and 70%.

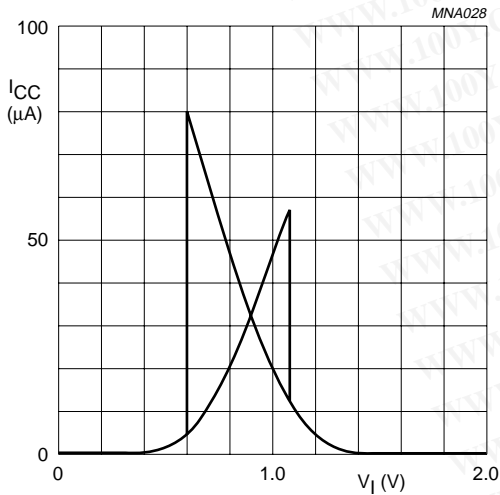

Fig.7 Typical HC1G14 transfer characteristics; $V_{CC} = 2.0\text{ V}$.

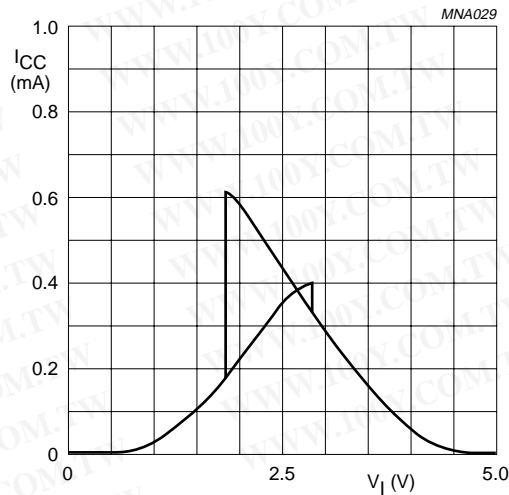
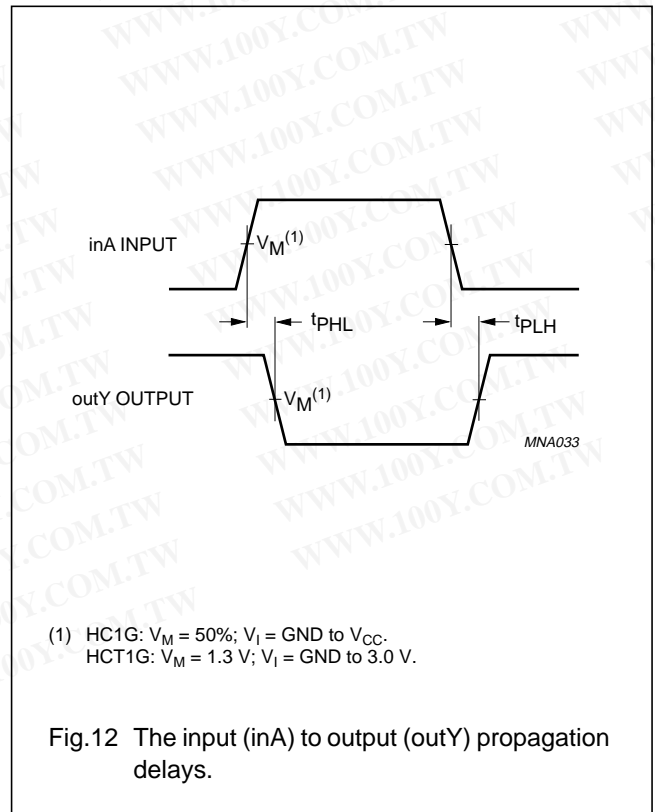
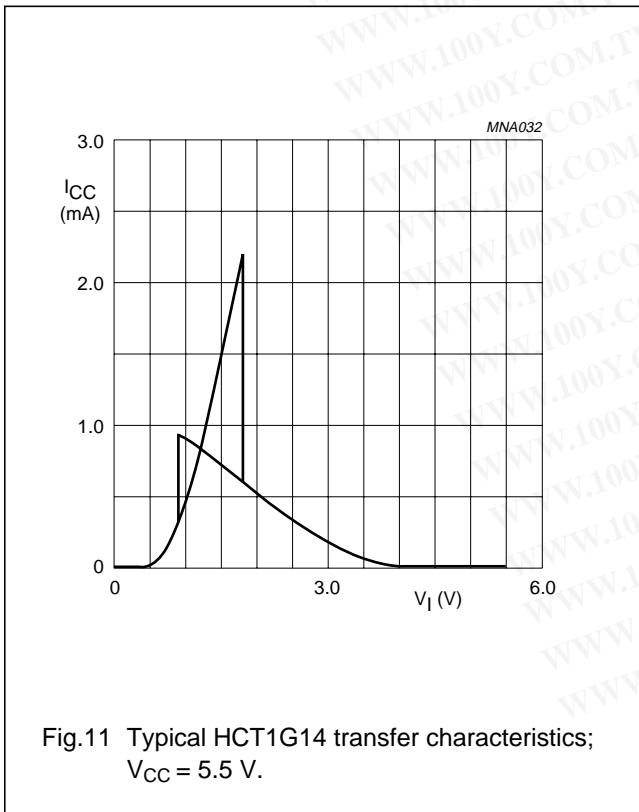
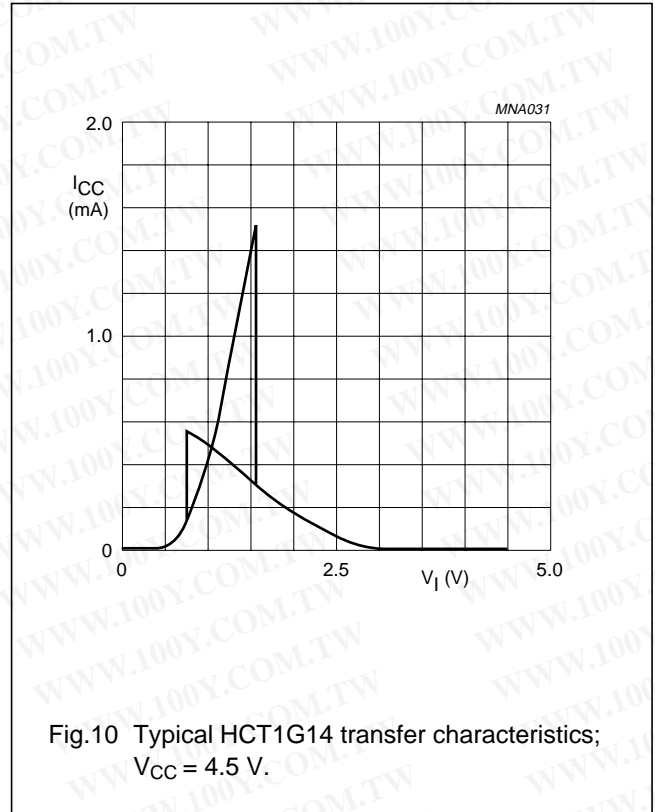
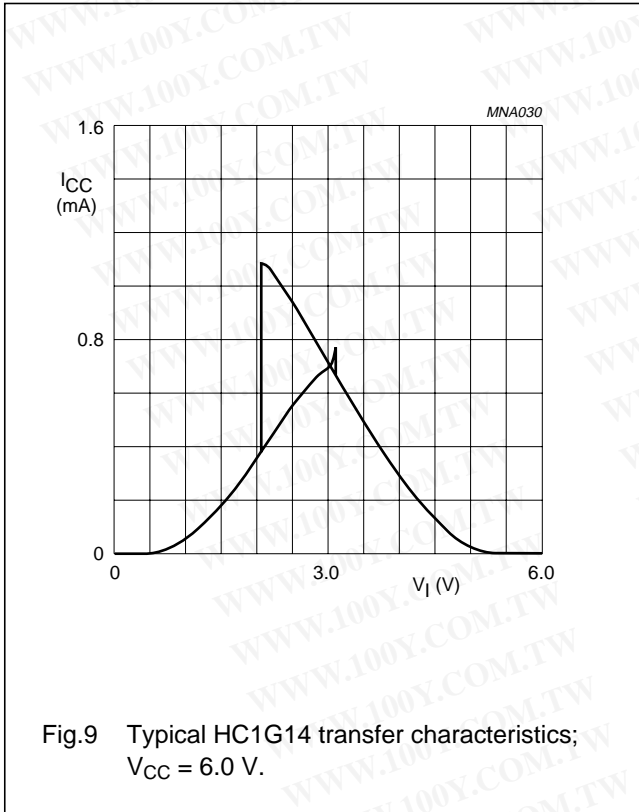

Fig.8 Typical HC1G14 transfer characteristics; $V_{CC} = 4.5\text{ V}$.

Inverting Schmitt-trigger

74HC1G14; 74HCT1G14



Inverting Schmitt-trigger

74HC1G14; 74HCT1G14

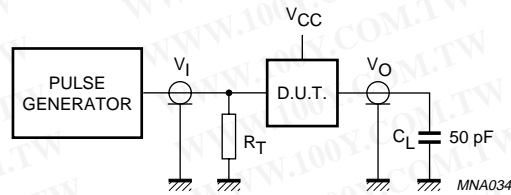

Definitions for test circuit:

C_L = load capacitance including jig and probe capacitance (See "AC characteristics for 74HC1G14" and "AC characteristics for 74HCT1G14" for values).

R_T = termination resistance should be equal to the output impedance Z_o of the pulse generator.

Fig.13 Load circuitry for switching times.

勝特力材料 886-3-5753170
 勝特力电子(上海) 86-21-54151736
 勝特力电子(深圳) 86-755-83298787
[Http://www.100y.com.tw](http://www.100y.com.tw)

Inverting Schmitt-trigger

74HC1G14; 74HCT1G14

APPLICATION INFORMATION

The slow input rise and fall times cause additional power dissipation, this can be calculated using the following formula:

$$P_{ad} = f_i \times (t_r \times I_{CCa} + t_f \times I_{CCa}) \times V_{CC}$$

Where:

P_{ad} = additional power dissipation (μW)

f_i = input frequency (MHz)

t_r = input rise time (ns); 10% to 90%

t_f = input fall time (ns); 90% to 10%

I_{CCa} = average additional supply current (μA).

Average I_{CCa} differs with positive or negative input transitions, as shown in Fig.14 and Fig.15.

HC1G/HCT1G14 used in relaxation oscillator circuit, see Fig.14 and Fig.16.

Note to the application information:

1. All values given are typical unless otherwise specified.

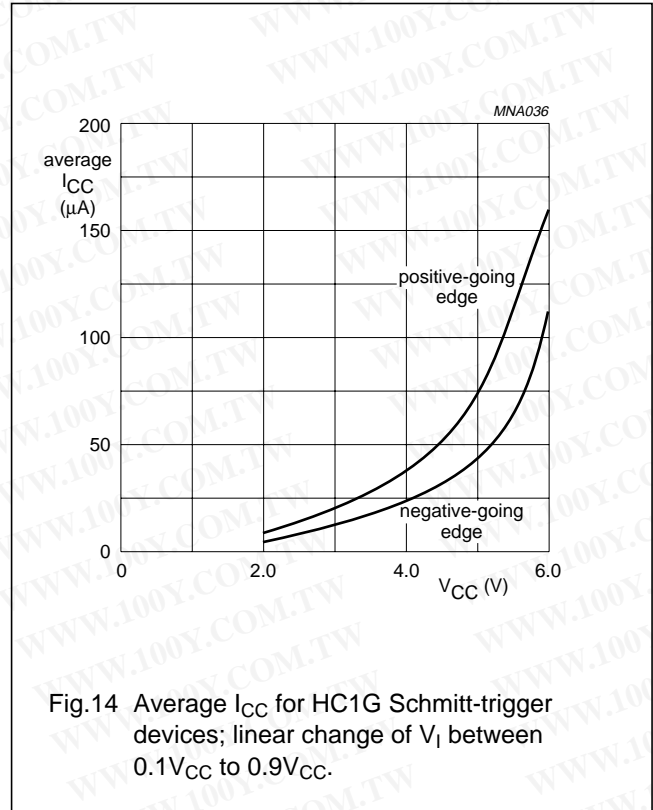

Fig.14 Average I_{CC} for HC1G Schmitt-trigger devices; linear change of V_I between $0.1V_{CC}$ to $0.9V_{CC}$.

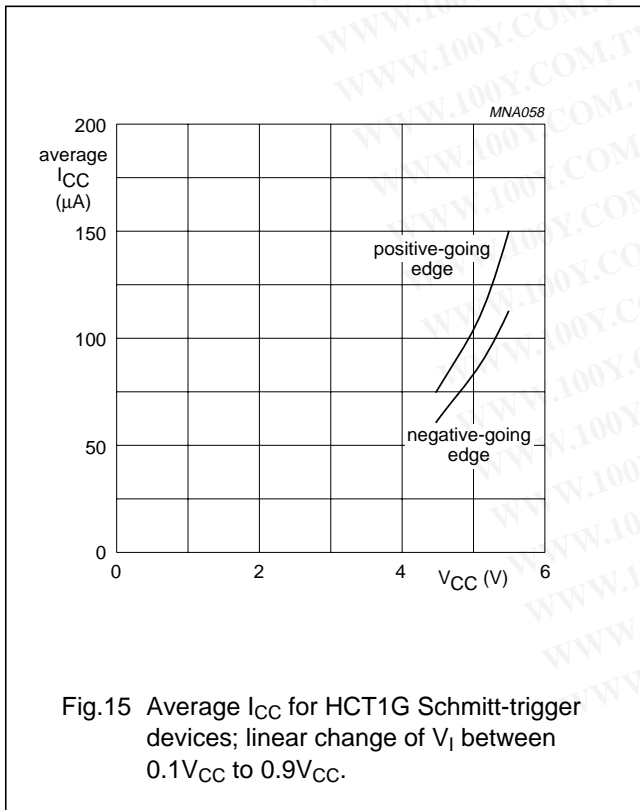
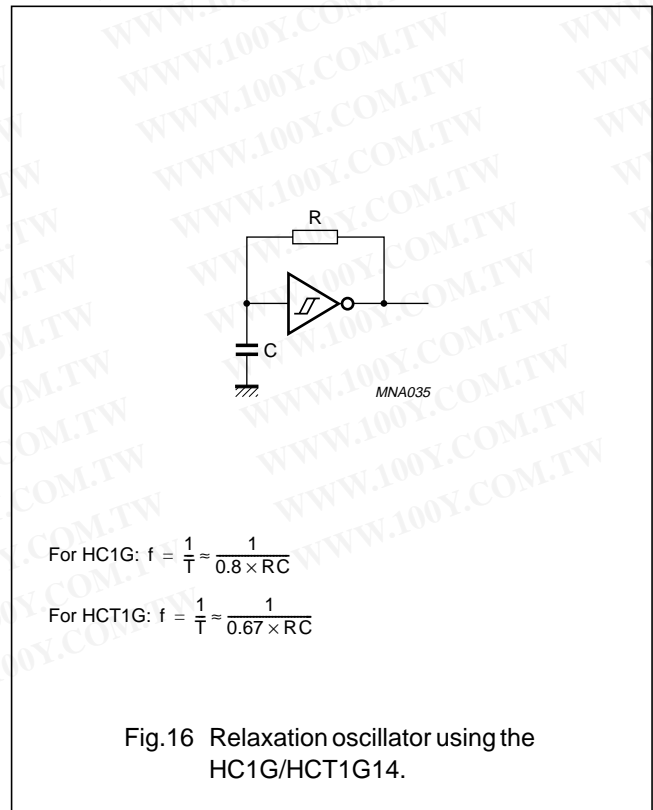

Fig.15 Average I_{CC} for HCT1G Schmitt-trigger devices; linear change of V_I between $0.1V_{CC}$ to $0.9V_{CC}$.



For HC1G: $f = \frac{1}{T} \approx \frac{1}{0.8 \times RC}$

For HCT1G: $f = \frac{1}{T} \approx \frac{1}{0.67 \times RC}$

Fig.16 Relaxation oscillator using the HC1G/HCT1G14.

Inverting Schmitt-trigger

74HC1G14; 74HCT1G14

PACKAGE OUTLINE

Plastic surface mounted package; 5 leads

SOT353

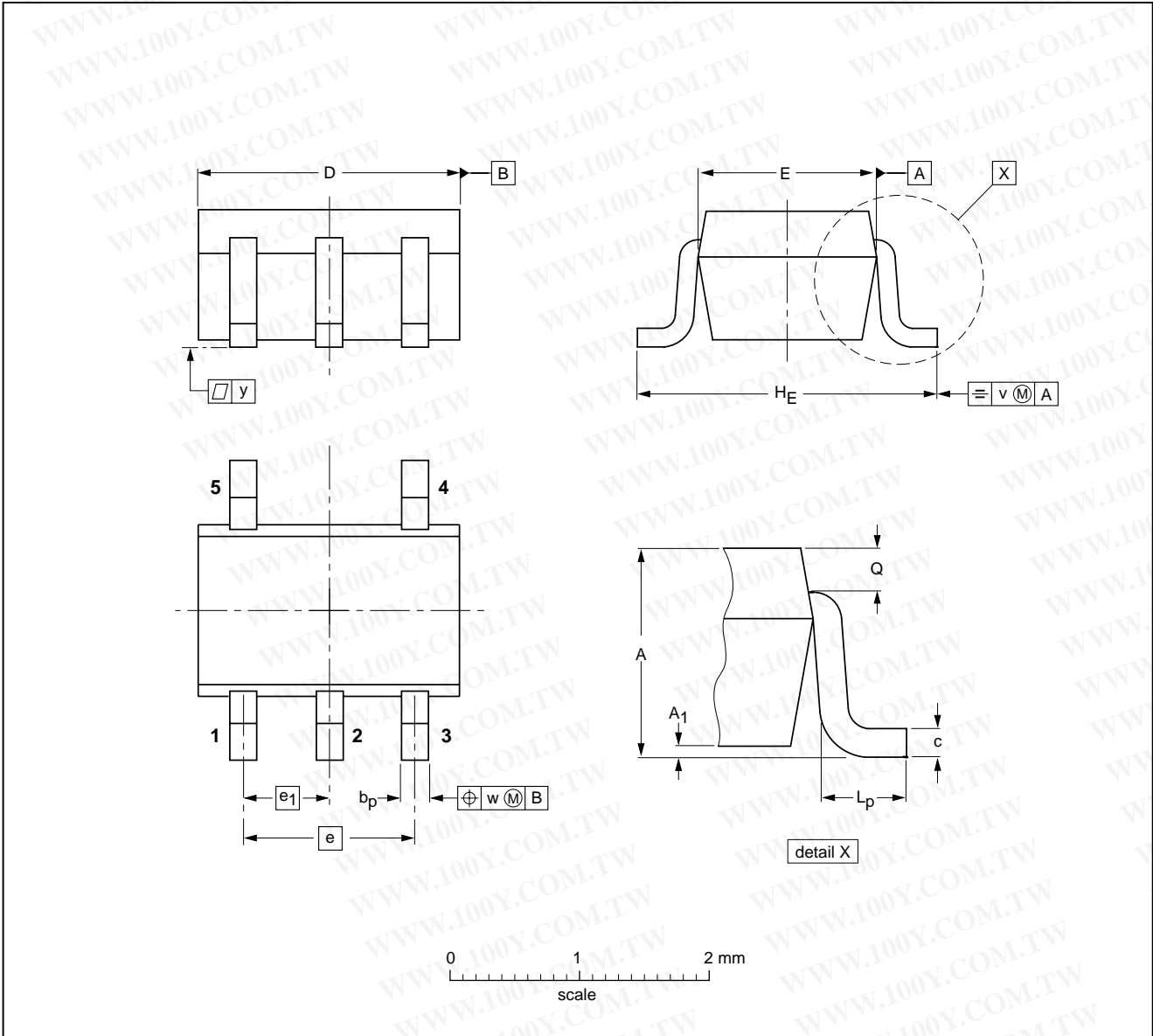

DIMENSIONS (mm are the original dimensions)

UNIT	A	A1 max	bp	c	D	E ⁽²⁾	e	e ₁	HE	Lp	Q	v	w	y
mm	1.1 0.8	0.1	0.30 0.20	0.25 0.10	2.2 1.8	1.35 1.15	1.3	0.65	2.2 2.0	0.45 0.15	0.25 0.15	0.2	0.2	0.1

OUTLINE VERSION	REFERENCES				EUROPEAN PROJECTION	ISSUE DATE
	IEC	JEDEC	EIAJ			
SOT353			SC-88A			97-02-28

Inverting Schmitt-trigger

74HC1G14; 74HCT1G14

SOLDERING

Introduction

There is no soldering method that is ideal for all IC packages. Wave soldering is often preferred when through-hole and surface mounted components are mixed on one printed-circuit board. However, wave soldering is not always suitable for surface mounted ICs, or for printed-circuits with high population densities. In these situations reflow soldering is often used.

This text gives a very brief insight to a complex technology. A more in-depth account of soldering ICs can be found in our "Data Handbook IC26; Integrated Circuit Packages" (order code 9398 652 90011).

Reflow soldering

Reflow soldering techniques are suitable for all SO packages.

Reflow soldering requires solder paste (a suspension of fine solder particles, flux and binding agent) to be applied to the printed-circuit board by screen printing, stencilling or pressure-syringe dispensing before package placement.

Several techniques exist for reflowing; for example, thermal conduction by heated belt. Dwell times vary between 50 and 300 seconds depending on heating method. Typical reflow temperatures range from 215 to 250 °C.

Preheating is necessary to dry the paste and evaporate the binding agent. Preheating duration: 45 minutes at 45 °C.

Wave soldering

Wave soldering techniques can be used for all SO packages if the following conditions are observed:

- A double-wave (a turbulent wave with high upward pressure followed by a smooth laminar wave) soldering technique should be used.
- The longitudinal axis of the package footprint must be parallel to the solder flow.
- The package footprint must incorporate solder thieves at the downstream end.

During placement and before soldering, the package must be fixed with a droplet of adhesive. The adhesive can be applied by screen printing, pin transfer or syringe dispensing. The package can be soldered after the adhesive is cured.

Maximum permissible solder temperature is 260 °C, and maximum duration of package immersion in solder is 10 seconds, if cooled to less than 150 °C within 6 seconds. Typical dwell time is 4 seconds at 250 °C.

A mildly-activated flux will eliminate the need for removal of corrosive residues in most applications.

Repairing soldered joints

Fix the component by first soldering two diagonally-opposite end leads. Use only a low voltage soldering iron (less than 24 V) applied to the flat part of the lead. Contact time must be limited to 10 seconds at up to 300 °C. When using a dedicated tool, all other leads can be soldered in one operation within 2 to 5 seconds between 270 and 320 °C.

勝特力材料 886-3-5753170
勝特力电子(上海) 86-21-54151736
勝特力电子(深圳) 86-755-83298787
[Http://www.100y.com.tw](http://www.100y.com.tw)

Inverting Schmitt-trigger

74HC1G14; 74HCT1G14

DEFINITIONS

Data sheet status	
Objective specification	This data sheet contains target or goal specifications for product development.
Preliminary specification	This data sheet contains preliminary data; supplementary data may be published later.
Product specification	This data sheet contains final product specifications.
Limiting values	
Limiting values given are in accordance with the Absolute Maximum Rating System (IEC 134). Stress above one or more of the limiting values may cause permanent damage to the device. These are stress ratings only and operation of the device at these or at any other conditions above those given in the Characteristics sections of the specification is not implied. Exposure to limiting values for extended periods may affect device reliability.	
Application information	
Where application information is given, it is advisory and does not form part of the specification.	

LIFE SUPPORT APPLICATIONS

These products are not designed for use in life support appliances, devices, or systems where malfunction of these products can reasonably be expected to result in personal injury. Philips customers using or selling these products for use in such applications do so at their own risk and agree to fully indemnify Philips for any damages resulting from such improper use or sale.

勝特力材料 886-3-5753170
 勝特力电子(上海) 86-21-54151736
 勝特力电子(深圳) 86-755-83298787
[Http://www.100y.com.tw](http://www.100y.com.tw)