

DATA SHEET

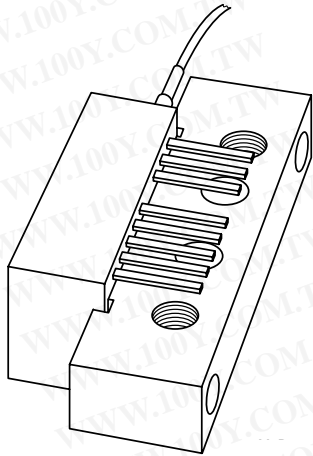

勝特力材料 886-3-5753170
胜特力电子(上海) 86-21-54151736
胜特力电子(深圳) 86-755-83298787
[Http://www.100y.com.tw](http://www.100y.com.tw)

BGO827; BGO827/FC0; BGO827/SC0 870 MHz optical receivers

Product specification
Supersedes data of 2002 Dec 10

2004 Apr 07

870 MHz optical receivers

BGO827; BGO827/FC0; BGO827/SC0

FEATURES

- Excellent linearity
- Low noise
- Excellent flatness
- Standard CATV outline
- Rugged construction
- Gold metallization ensures excellent reliability
- High optical input power range.

APPLICATIONS

CATV optical node systems operating in the 40 to 870 MHz frequency range.

DESCRIPTION

High dynamic range optical receiver amplifier modules in a standard SOT115 package where the non-jacketed fibre has either no connector or has an FC/APC or SC/APC connector.

The amplifier supply voltage pin and the photo diode bias voltage pin both connect to 24 V (DC).

The modules have a monomode optical input suitable for 1290 to 1600 nm wavelengths, a terminal to monitor the photo diode current and an electrical output having a characteristic impedance of 75 Ω.

PINNING

PIN	DESCRIPTION
1	monitor current
2	common
3	common
4	+V _B of the photo diode
5	+V _B of the amplifier
7	common
8	common
9	output

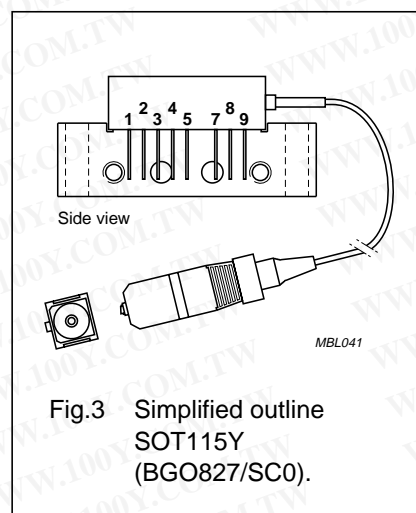
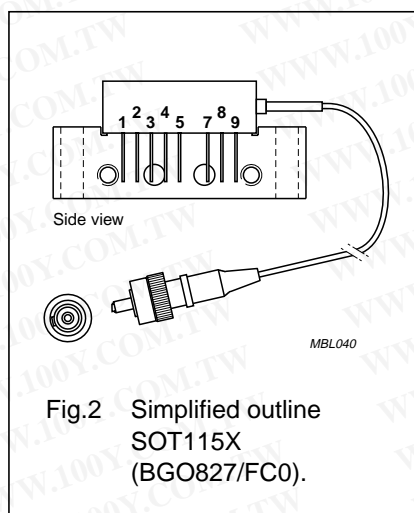
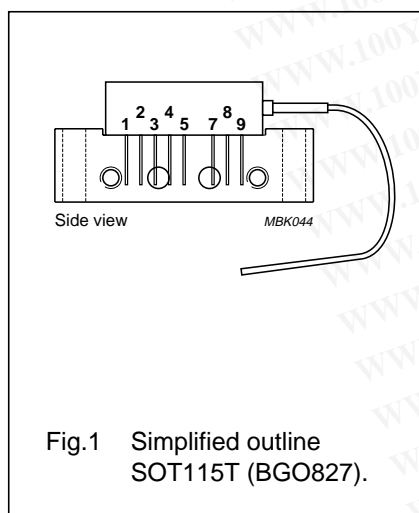

QUICK REFERENCE DATA

SYMBOL	PARAMETER	CONDITIONS	MIN.	MAX.	UNIT
f	frequency range		40	870	MHz
S ₂₂	output return losses	f = 40 to 870 MHz	11	–	dB
	optical input return losses		45	–	dB
d ₂	second order distortion	f = 854.5 MHz	–	–57	dB
F	equivalent noise input	f = 40 to 870 MHz	–	8.5	pA/√Hz
I _{tot}	total current consumption (DC)	V _B = 24 V	175	205	mA

CAUTION

This product is supplied in anti-static packing to prevent damage caused by electrostatic discharge during transport and handling. For further information, refer to Philips specs.: SNW-EQ-608, SNW-FQ-302A and SNW-FQ-302B.

870 MHz optical receivers

BGO827; BGO827/FC0;
 BGO827/SC0

ORDERING INFORMATION

TYPE NUMBER	PACKAGE		
	NAME	DESCRIPTION	VERSION
BGO827	–	rectangular single-ended package; aluminium flange; 2 vertical mounting holes; 2 x 6-32 UNC and 2 extra horizontal mounting holes; optical input; 8 gold-plated in-line leads	SOT115T
BGO827/FC0	–	rectangular single-ended package; aluminium flange; 2 vertical mounting holes; 2 x 6-32 UNC and 2 extra horizontal mounting holes; optical input with connector; 8 gold-plated in-line leads	SOT115X
BGO827/SC0	–	rectangular single-ended package; aluminium flange; 2 vertical mounting holes; 2 x 6-32 UNC and 2 extra horizontal mounting holes; optical input with connector; 8 gold-plated in-line leads	SOT115Y

HANDLING

Fibreglass optical coupling: maximum tensile strength = 5 N; minimum bending radius = 35 mm.

LIMITING VALUES

In accordance with the Absolute Maximum Rating System (IEC 60134).

SYMBOL	PARAMETER	CONDITIONS	MIN.	MAX.	UNIT
f	frequency range		40	870	MHz
T _{stg}	storage temperature		–40	+85	°C
T _{mb}	operating mounting base temperature		–20	+85	°C
P _{in}	optical input power	continuous	–	5	mW
ESD	ESD sensitivity	human body model; R = 1.5 kΩ; C = 100 pF	500	–	V

CHARACTERISTICS

Bandwidth 40 to 870 MHz; V_B = 24 V; T_{mb} = 30 °C; Z_L = 75 Ω.

SYMBOL	PARAMETER	CONDITIONS	MIN.	TYP.	MAX.	UNIT
S	responsivity BGO827 BGO827/FC0, BGO827/SC0	λ = 1300 nm	800	–	–	V/W
			750	–	–	V/W
ΔS	responsivity difference	resp at T _{mb} = 85 °C – resp at T _{mb} = 30 °C; f = 870 MHz	–	–50	–	V/W
FL	flatness straight line (peak to valley)	f = 40 to 870 MHz	–	–	1	dB
SL	slope straight line	f = 40 to 870 MHz	0	–	2	dB
ΔSL	slope difference	slope at T _{mb} = 85 °C – slope at T _{mb} = 30 °C	–	–0.35	–	dB
S ₂₂	output return losses	f = 40 to 870 MHz	11	–	–	dB
	optical input return losses		45	–	–	dB

870 MHz optical receivers

BGO827; BGO827/FC0;
 BGO827/SC0

SYMBOL	PARAMETER	CONDITIONS	MIN.	TYP.	MAX.	UNIT
d ₂	second order distortion	f _m = 446.5 MHz; notes 1 and 3	-	-	-68	dB
		f _m = 746.5 MHz; notes 1 and 4	-	-	-63	dB
		f _m = 854.5 MHz; notes 1 and 5	-	-	-57	dB
Δd ₂	second order distortion difference	d ₂ at T _{mb} = 85 °C - d ₂ at T _{mb} = 30 °C	-	2.5	-	dB
		d ₂ at T _{mb} = -20 °C - d ₂ at T _{mb} = 30 °C	-	-1.5	-	dB
d ₃	third order distortion	f _m = 853.25 MHz; notes 2 and 6	-	-	-73	dB
Δd ₃	third order distortion difference	d ₃ at T _{mb} = 85 °C - d ₃ at T _{mb} = 30 °C	-	1	-	dB
		d ₃ at T _{mb} = -20 °C - d ₃ at T _{mb} = 30 °C	-	-1	-	dB
F	equivalent noise input	f = 40 to 450 MHz	-	-	7	pA/√Hz
		f = 450 to 750 MHz	-	-	8	pA/√Hz
		f = 750 to 870 MHz	-	-	8.5	pA/√Hz
s _λ	spectral sensitivity	λ = 1310 ±20 nm	0.85	-	-	A/W
		λ = 1550 ±20 nm	0.9	-	-	A/W
λ	optical wavelength		1290	-	1600	nm
L	length of optical fibre BGO827 BGO827/FC0, BGO827/SC0	fibre; SM type; 9/125 μm				
			1	-	-	m
			746	-	861	mm
I _{tot}	total current consumption (DC)		175	-	205	mA
I _{bias}	diode bias current at pin 4 (DC)		-	-	25	mA

Notes

- Two laser test; each laser with a modulation index of 40%; P_{opt} = 1 mW (total).
- Three laser test; each laser with a modulation index of 60%; P_{opt} = 1 mW (total).
- f_m = 446.5 MHz; f_p = 97.25 MHz; f_q = 349.25 MHz.
- f_m = 746.5 MHz; f_p = 133.25 MHz; f_q = 613.25 MHz.
- f_m = 854.5 MHz; f_p = 133.25 MHz; f_q = 721.25 MHz.
- f_m = 853.25 MHz; f_p = 133.25 MHz; f_q = 265.25 MHz; f_r = 721.25 MHz.

870 MHz optical receivers

BGO827; BGO827/FC0;
BGO827/SC0

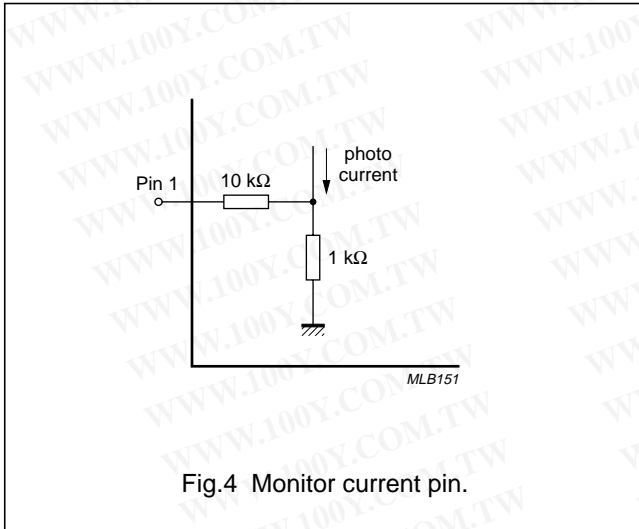

870 MHz optical receivers

BGO827; BGO827/FC0;
BGO827/SC0

PACKAGE OUTLINES

Rectangular single-ended package; aluminium flange; 2 vertical mounting holes; 2 x 6-32 UNC and 2 extra horizontal mounting holes; optical input; 8 gold-plated in-line leads SOT115T

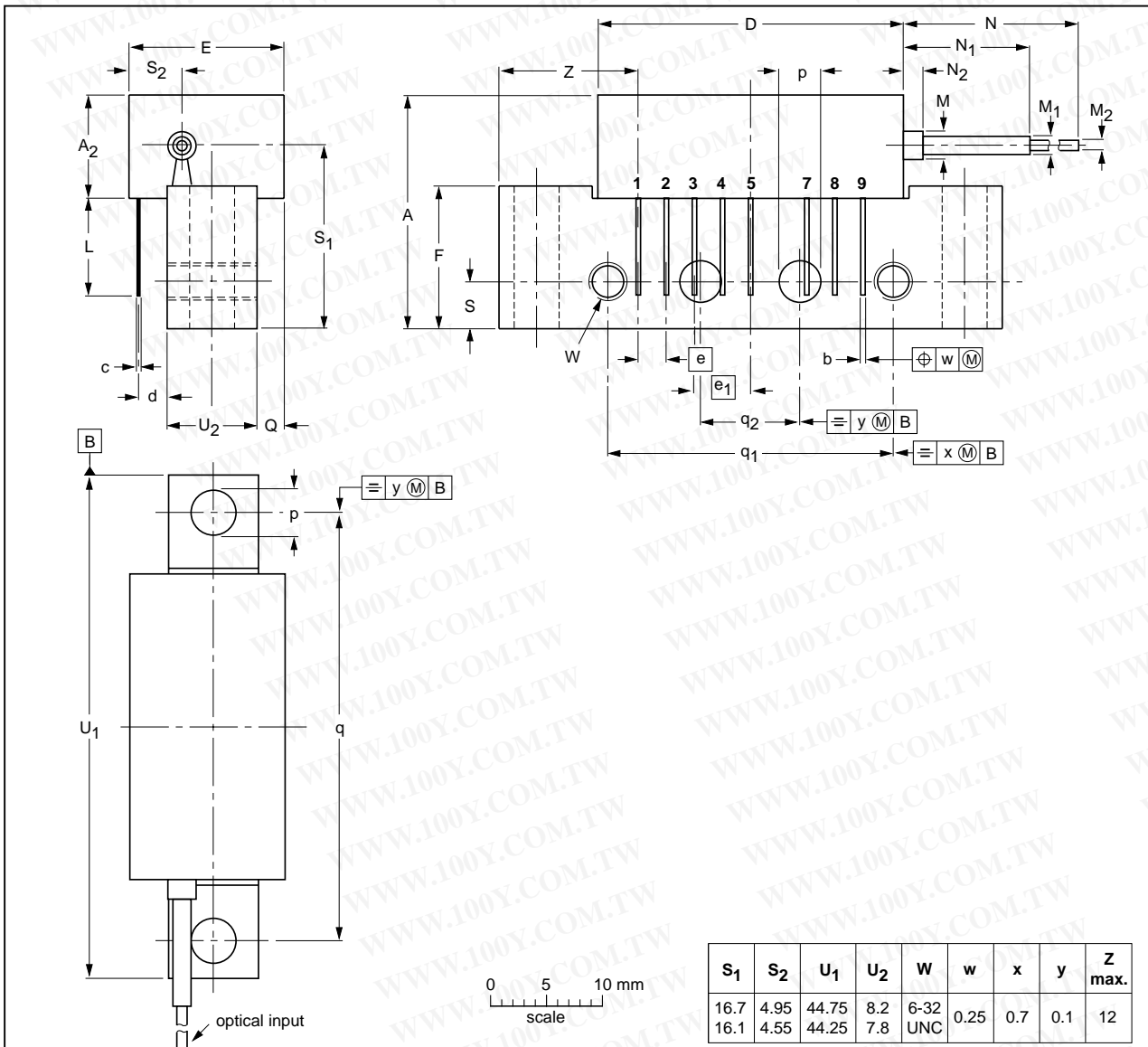

S ₁	S ₂	U ₁	U ₂	W	w	x	y	Z max.
16.7	4.95	44.75	8.2	6-32	0.25	0.7	0.1	12
16.1	4.55	44.25	7.8	UNC				

DIMENSIONS (mm are the original dimensions)

UNIT	A max.	A ₂ max.	b	c	D max.	d max.	E max.	e	e ₁	F	L min.	M	M ₁	M ₂	N min.	N ₁	N ₂	p	Q max.	q	q ₁	q ₂	S
mm	20.8	9.1	0.51 0.38	0.25	27.2	2.54	13.75	2.54	5.08	12.7	8.8	2.5	1.6	0.9	1000	10.7 0.0	5 0	4.15 3.85	2.4	38.1	25.4	10.2	4.2

OUTLINE VERSION	REFERENCES			EUROPEAN PROJECTION	ISSUE DATE
	IEC	JEDEC	JEITA		
SOT115T					01-08-10 04-02-04

870 MHz optical receivers

BGO827; BGO827/FC0;
BGO827/SC0

Rectangular single-ended package; aluminium flange;
 2 vertical mounting holes; 2 x 6-32 UNC and 2 extra horizontal mounting holes;
 optical input with connector; 8 gold-plated in-line leads

SOT115X

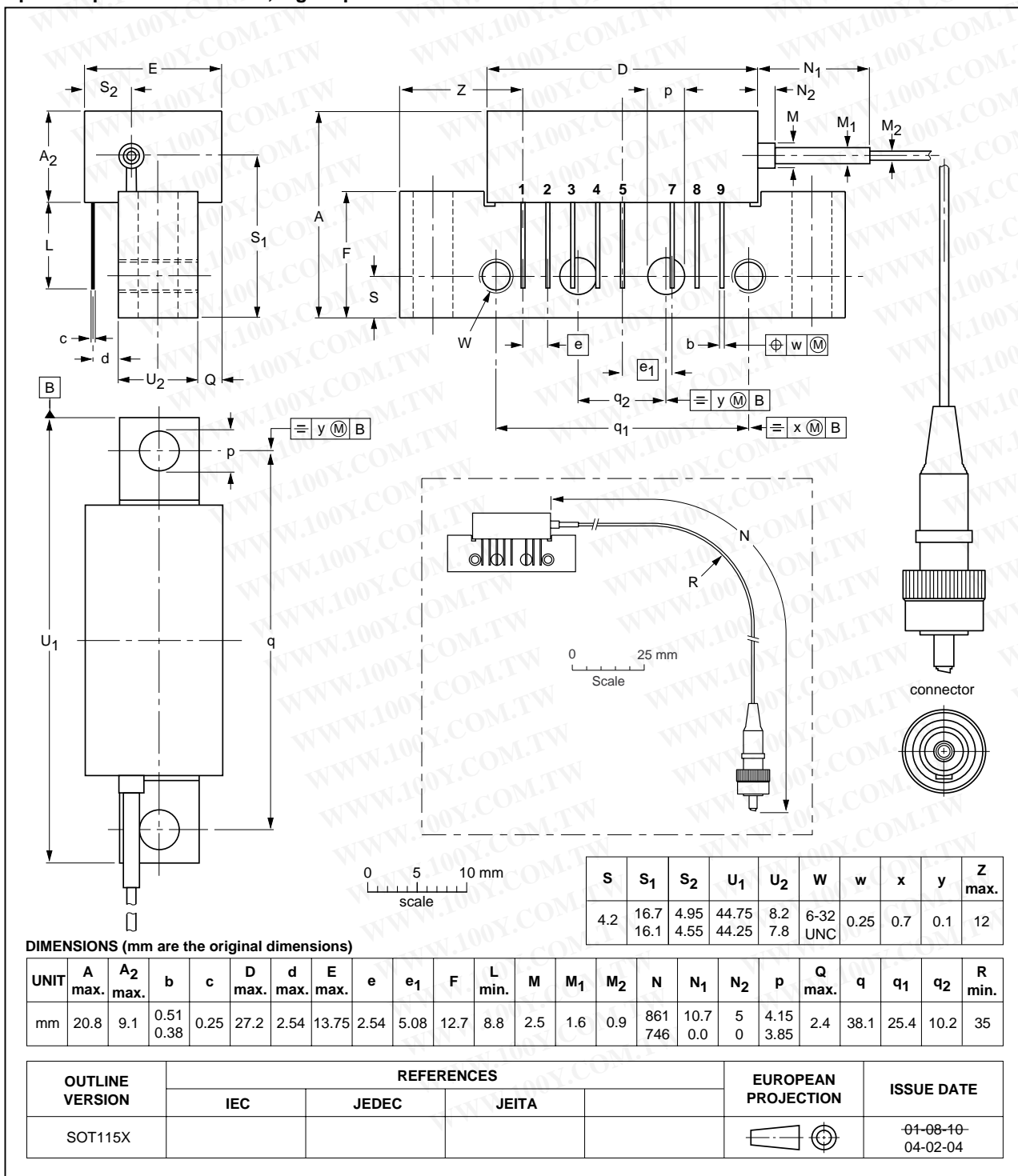

870 MHz optical receivers

BGO827; BGO827/FC0;
 BGO827/SC0

Rectangular single-ended package; aluminium flange;
 2 vertical mounting holes; 2 x 6-32 UNC and 2 extra horizontal mounting holes;
 optical input with connector; 8 gold-plated in-line leads

SOT115Y

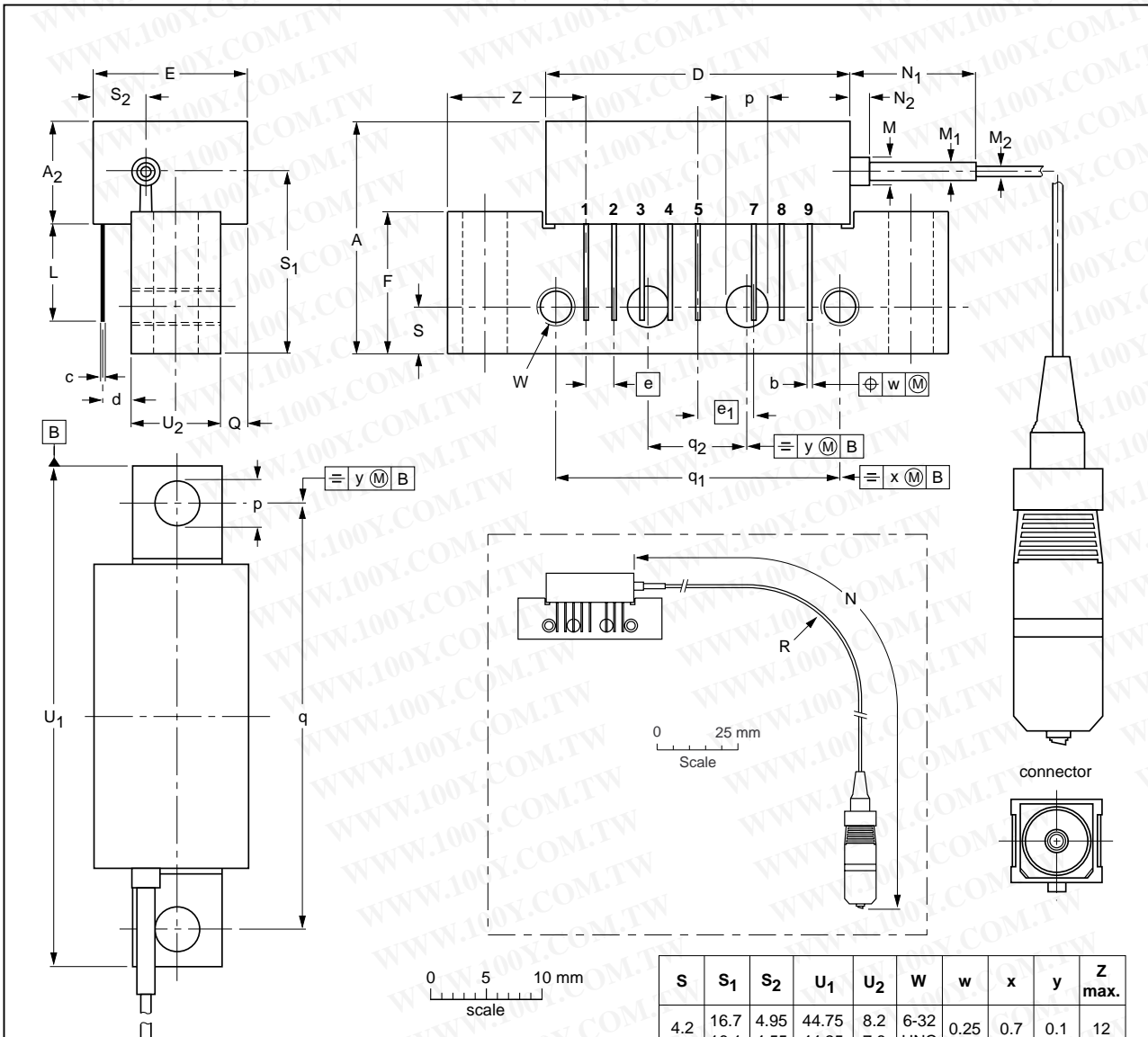

S	S ₁	S ₂	U ₁	U ₂	W	w	x	y	Z max.
4.2	16.7	4.95	44.75	8.2	6-32	0.25	0.7	0.1	12
	16.1	4.55	44.25	7.8	UNC				

DIMENSIONS (mm are the original dimensions)

UNIT	A max.	A ₂ max.	b	c	D max.	d max.	E max.	e	e ₁	F	L min.	M	M ₁	M ₂	N	N ₁	N ₂	p	Q max.	q	q ₁	q ₂	R min.
mm	20.8	9.1	0.51 0.38	0.25	27.2	2.54	13.75	2.54	5.08	12.7	8.8	2.5	1.6	0.9	861 746	10.7 0.0	5 0	4.15 3.85	2.4	38.1	25.4	10.2	35

OUTLINE VERSION	REFERENCES			EUROPEAN PROJECTION	ISSUE DATE
	IEC	JEDEC	JEITA		
SOT115Y					01-08-10 04-02-05

870 MHz optical receivers

BGO827; BGO827/FC0;
 BGO827/SC0

DATA SHEET STATUS

LEVEL	DATA SHEET STATUS ⁽¹⁾	PRODUCT STATUS ⁽²⁾⁽³⁾	DEFINITION
I	Objective data	Development	This data sheet contains data from the objective specification for product development. Philips Semiconductors reserves the right to change the specification in any manner without notice.
II	Preliminary data	Qualification	This data sheet contains data from the preliminary specification. Supplementary data will be published at a later date. Philips Semiconductors reserves the right to change the specification without notice, in order to improve the design and supply the best possible product.
III	Product data	Production	This data sheet contains data from the product specification. Philips Semiconductors reserves the right to make changes at any time in order to improve the design, manufacturing and supply. Relevant changes will be communicated via a Customer Product/Process Change Notification (CPCN).

Notes

1. Please consult the most recently issued data sheet before initiating or completing a design.
2. The product status of the device(s) described in this data sheet may have changed since this data sheet was published. The latest information is available on the Internet at URL <http://www.semiconductors.philips.com>.
3. For data sheets describing multiple type numbers, the highest-level product status determines the data sheet status.

DEFINITIONS

Short-form specification — The data in a short-form specification is extracted from a full data sheet with the same type number and title. For detailed information see the relevant data sheet or data handbook.

Limiting values definition — Limiting values given are in accordance with the Absolute Maximum Rating System (IEC 60134). Stress above one or more of the limiting values may cause permanent damage to the device. These are stress ratings only and operation of the device at these or at any other conditions above those given in the Characteristics sections of the specification is not implied. Exposure to limiting values for extended periods may affect device reliability.

Application information — Applications that are described herein for any of these products are for illustrative purposes only. Philips Semiconductors make no representation or warranty that such applications will be suitable for the specified use without further testing or modification.

DISCLAIMERS

Life support applications — These products are not designed for use in life support appliances, devices, or systems where malfunction of these products can reasonably be expected to result in personal injury. Philips Semiconductors customers using or selling these products for use in such applications do so at their own risk and agree to fully indemnify Philips Semiconductors for any damages resulting from such application.

Right to make changes — Philips Semiconductors reserves the right to make changes in the products - including circuits, standard cells, and/or software - described or contained herein in order to improve design and/or performance. When the product is in full production (status 'Production'), relevant changes will be communicated via a Customer Product/Process Change Notification (CPCN). Philips Semiconductors assumes no responsibility or liability for the use of any of these products, conveys no licence or title under any patent, copyright, or mask work right to these products, and makes no representations or warranties that these products are free from patent, copyright, or mask work right infringement, unless otherwise specified.

勝特力材料 886-3-5753170
勝特力电子(上海) 86-21-54151736
勝特力电子(深圳) 86-755-83298787
[Http://www.100y.com.tw](http://www.100y.com.tw)

Philips Semiconductors – a worldwide company

Contact information

For additional information please visit <http://www.semiconductors.philips.com>. Fax: +31 40 27 24825

For sales offices addresses send e-mail to: sales.addresses@www.semiconductors.philips.com.

© Koninklijke Philips Electronics N.V. 2004

SCA76

All rights are reserved. Reproduction in whole or in part is prohibited without the prior written consent of the copyright owner.

The information presented in this document does not form part of any quotation or contract, is believed to be accurate and reliable and may be changed without notice. No liability will be accepted by the publisher for any consequence of its use. Publication thereof does not convey nor imply any license under patent- or other industrial or intellectual property rights.

Printed in The Netherlands

R77/03/pp10

Date of release: 2004 Apr 07

Document order number: 9397 750 13061

Let's make things better.

Philips
Semiconductors



PHILIPS