

Standard 78 series, 3-pin regulator

BA17800T / FP series

The BA17800T and BA17800FP series are 3pin fixed positive output voltage regulators. These regulators are used to provide a stabilized output voltage from a fluctuating DC input voltage.

There are 11 fixed output voltages, as follows : 5V, 6V, 7V, 8V, 9V, 10V, 12V, 15V, 18V, 20V, and 24V. The maximum current capacity is 1A for each of the above voltages.

●Application

Constant voltage power supply

●Features

- 1) Built-in overcurrent protection circuit and thermal shutdown circuit.
- 2) Excellent ripple regulation.
- 3) Available in TO220FP and TO252-3 packages, to meet wide range of applications.
- 4) Compatible with other manufacturers' regulators.
- 5) Richly diverse lineup (5V, 6V, 7V, 8V, 9V, 10V, 12V, 15V, 18V, 20V, 24V).

●Product codes

Output voltage (V)	Product name	Output voltage (V)	Product name
5	BA17805T / FP	12	BA17812T / FP
6	BA17806T / FP	15	BA17815T / FP
7	BA17807T / FP	18	BA17818T / FP
8	BA17808T / FP	20	BA17820T / FP
9	BA17809T / FP	24	BA17824T / FP
10	BA17810T / FP	-	-

Regulator ICs

●Internal circuit configuration diagram

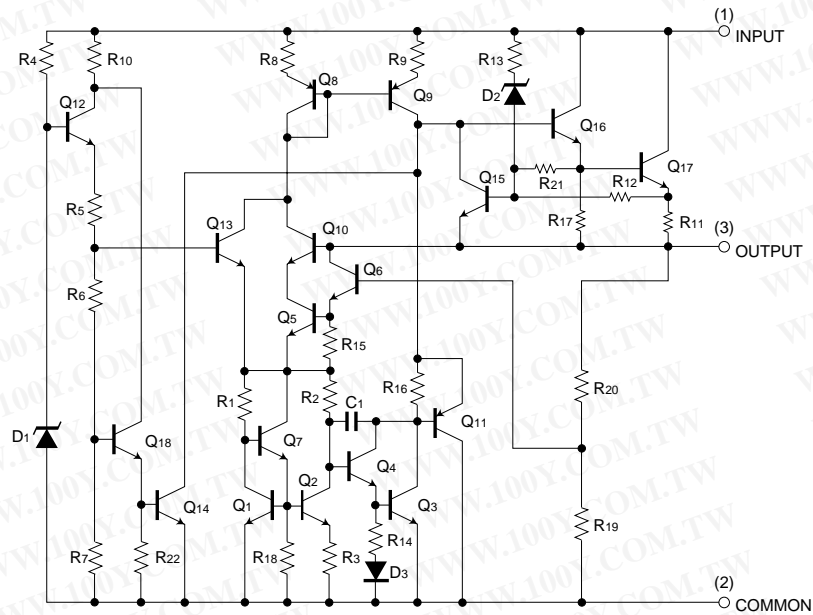

●Absolute maximum ratings (Ta=25°C)

«Common specifications for BA17800T / FP series»

Parameter	Symbol	Limits	Unit
Applied voltage	V _{IN}	35	V
Power dissipation	TO220FP	2.0 *	W
	TO252-3	1.0 *	
Operating temperature	T _{opr}	-40~+85	°C
Storage temperature	T _{stg}	-55~+150	°C

* Reduced by 16 mW / °C (TO220FP) and 8 mW / °C (TO252-3) for each increase in Ta of 1°C over 25°C (without heat sink).

●Recommended operating conditions (Ta=25°C)

BA17805T / FP

Parameter	Symbol	Min.	Typ.	Max.	Unit
Input voltage	V _{IN}	7.5	-	25	V
Output current	I _o	-	-	1	A

BA17806T / FP

Parameter	Symbol	Min.	Typ.	Max.	Unit
Input voltage	V _{IN}	8.5	-	21	V
Output current	I _o	-	-	1	A

BA17807T / FP

Parameter	Symbol	Min.	Typ.	Max.	Unit
Input voltage	V _{IN}	9.5	-	22	V
Output current	I _o	-	-	1	A

BA17808T / FP

Parameter	Symbol	Min.	Typ.	Max.	Unit
Input voltage	V _{IN}	10.5	-	23	V
Output current	I _o	-	-	1	A

Regulator ICs

BA17809T / FP

Parameter	Symbol	Min.	Typ.	Max.	Unit
Input voltage	V_{IN}	11.5	-	26	V
Output current	I_o	-	-	1	A

BA17810T / FP

Parameter	Symbol	Min.	Typ.	Max.	Unit
Input voltage	V_{IN}	12.5	-	25	V
Output current	I_o	-	-	1	A

BA17812T / FP

Parameter	Symbol	Min.	Typ.	Max.	Unit
Input voltage	V_{IN}	15	-	27	V
Output current	I_o	-	-	1	A

BA17815T / FP

Parameter	Symbol	Min.	Typ.	Max.	Unit
Input voltage	V_{IN}	17.5	-	30	V
Output current	I_o	-	-	1	A

BA17818T / FP

Parameter	Symbol	Min.	Typ.	Max.	Unit
Input voltage	V_{IN}	21	-	33	V
Output current	I_o	-	-	1	A

BA17820T / FP

Parameter	Symbol	Min.	Typ.	Max.	Unit
Input voltage	V_{IN}	23	-	33	V
Output current	I_o	-	-	1	A

BA17824T / FP

Parameter	Symbol	Min.	Typ.	Max.	Unit
Input voltage	V_{IN}	27	-	33	V
Output current	I_o	-	-	1	A

●Electrical characteristics

<BA17805T / FP individual specifications> (unless otherwise noted, $T_a=25^\circ\text{C}$, $V_{IN}=10\text{V}$, $I_o=500\text{mA}$)

Parameter	Symbol	Min.	Typ.	Max.	Unit	Conditions	Measurement circuit
Output voltage 1	V_{O1}	4.8	5.0	5.2	V	$I_o=500\text{mA}$	Fig.1
Output voltage 2	V_{O2}	4.75	-	5.25	V	$V_{IN}=7.5\sim 20\text{V}$, $I_o=5\text{mA}\sim 1\text{A}$	Fig.1
Input stability 1	Reg.l1	-	3	100	mV	$V_{IN}=7\sim 25\text{V}$, $I_o=500\text{mA}$	Fig.1
Input stability 2	Reg.l2	-	1	50	mV	$V_{IN}=8\sim 12\text{V}$, $I_o=500\text{mA}$	Fig.1
Ripple rejection ratio	R.R.	62	78	-	dB	$e_{IN}=1\text{V}_{rms}$, $f=120\text{Hz}$, $I_o=100\text{mA}$	Fig.2
Load regulation 1	Reg.L1	-	15	100	mV	$I_o=5\text{mA}\sim 1\text{A}$	Fig.1
Load regulation 2	Reg.L2	-	5	50	mV	$I_o=250\sim 750\text{mA}$	Fig.1
Temperature coefficient of output voltage	T_{CVO}	-	-1.0	-	$\text{mV}/^\circ\text{C}$	$I_o=5\text{mA}$, $T_j=0\sim 125^\circ\text{C}$	Fig.1
Output noise voltage	V_n	-	40	-	μV	$f=10\text{Hz}\sim 100\text{kHz}$	Fig.3
Minimum I/O voltage differential	V_d	-	2.0	-	V	$I_o=1\text{A}$	Fig.4
Bias current	I_b	-	4.5	8.0	mA	$I_o=0\text{mA}$	Fig.5
Bias current change 1	I_{b1}	-	-	0.5	mA	$I_o=5\text{mA}\sim 1\text{A}$	Fig.5
Bias current change 2	I_{b2}	-	-	0.8	mA	$V_{IN}=8\sim 25\text{V}$	Fig.5
Peak output current	I_{o-P}	-	1.7	-	A	$T_j=25^\circ\text{C}$	Fig.1
Output short-circuit current	I_{os}	-	0.6	-	A	$V_{IN}=25\text{V}$	Fig.6

Regulator ICs

<BA17806T / FP individual specifications> (unless otherwise noted, Ta=25°C, VIN=11V, Io=500mA)

Parameter	Symbol	Min.	Typ.	Max.	Unit	Conditions	Measurement circuit
Output voltage 1	VO1	5.75	6.0	6.25	V	Io=500mA	Fig.1
Output voltage 2	VO2	5.7	-	6.3	V	VIN=8.5~21V, Io=5mA~1A	Fig.1
Input stability 1	Reg.l1	-	4	120	mV	VIN=8~25V, Io=500mA	Fig.1
Input stability 2	Reg.l2	-	2	60	mV	VIN=9~13V, Io=500mA	Fig.1
Ripple rejection ratio	R.R.	59	73	-	dB	eIN=1Vrms, f=120Hz, Io=100mA	Fig.2
Load regulation 1	Reg.L1	-	16	120	mV	Io=5mA~1A	Fig.1
Load regulation 2	Reg.L2	-	6	60	mV	Io=250~750mA	Fig.1
Temperature coefficient of output voltage	Tcvo	-	-0.5	-	mV/°C	Io=5mA, Tj=0~125°C	Fig.1
Output noise voltage	Vn	-	60	-	μV	f=10Hz~100kHz	Fig.3
Minimum I/O voltage differential	Vd	-	2.0	-	V	Io=1A	Fig.4
Bias current	Ib	-	4.5	8.0	mA	Io=0mA	Fig.5
Bias current change 1	Ib1	-	-	0.5	mA	Io=5mA~1A	Fig.5
Bias current change 2	Ib2	-	-	0.8	mA	VIN=8.5~25V	Fig.5
Peak output current	Io-P	-	1.7	-	A	Tj=25°C	Fig.1
Output short-circuit current	Ios	-	0.6	-	A	VIN=25V	Fig.6

<BA17807T / FP individual specifications> (unless otherwise noted, Ta=25°C, VIN=13V, Io=500mA)

Parameter	Symbol	Min.	Typ.	Max.	Unit	Conditions	Measurement circuit
Output voltage 1	VO1	6.7	7.0	7.3	V	Io=500mA	Fig.1
Output voltage 2	VO2	6.65	-	7.35	V	VIN=9.5~22V, Io=5mA~1A	Fig.1
Input stability 1	Reg.l1	-	5	140	mV	VIN=9~25V, Io=500mA	Fig.1
Input stability 2	Reg.l2	-	2	70	mV	VIN=10~15V, Io=500mA	Fig.1
Ripple rejection ratio	R.R.	57	69	-	dB	eIN=1Vrms, f=120Hz, Io=100mA	Fig.2
Load regulation 1	Reg.L1	-	17	140	mV	Io=5mA~1A	Fig.1
Load regulation 2	Reg.L2	-	6	70	mV	Io=250~750mA	Fig.1
Temperature coefficient of output voltage	Tcvo	-	-0.5	-	mV/°C	Io=5mA, Tj=0~125°C	Fig.1
Output noise voltage	Vn	-	70	-	μV	f=10Hz~100kHz	Fig.3
Minimum I/O voltage differential	Vd	-	2.0	-	V	Io=1A	Fig.4
Bias current	Ib	-	4.5	8.5	mA	Io=0mA	Fig.5
Bias current change 1	Ib1	-	-	0.5	mA	Io=5mA~1A	Fig.5
Bias current change 2	Ib2	-	-	0.8	mA	VIN=9.5~25V	Fig.5
Peak output current	Io-P	-	1.7	-	A	Tj=25°C	Fig.1
Output short-circuit current	Ios	-	0.6	-	A	VIN=25V	Fig.6

BA17800T / FP series

Regulator ICs

<BA17808T / FP individual specifications> (unless otherwise noted, Ta=25°C, VIN=14V, Io=500mA)

Parameter	Symbol	Min.	Typ.	Max.	Unit	Conditions	Measurement circuit
Output voltage 1	V _{O1}	7.7	8.0	8.3	V	I _o =500mA	Fig.1
Output voltage 2	V _{O2}	7.6	-	8.4	V	V _{IN} =10.5~23V, I _o =5mA~1A	Fig.1
Input stability 1	Reg.L ₁	-	5	160	mV	V _{IN} =10.5~25V, I _o =500mA	Fig.1
Input stability 2	Reg.L ₂	-	3	80	mV	V _{IN} =11~17V, I _o =500mA	Fig.1
Ripple rejection ratio	R.R.	56	65	-	dB	e _{IN} =1V _{rms} , f=120Hz, I _o =100mA	Fig.2
Load regulation 1	Reg.L ₁	-	19	160	mV	I _o =5mA~1A	Fig.1
Load regulation 2	Reg.L ₂	-	7	80	mV	I _o =250~750mA	Fig.1
Temperature coefficient of output voltage	T _{CV_O}	-	-0.5	-	mV/°C	I _o =5mA, T _j =0~125°C	Fig.1
Output noise voltage	V _n	-	80	-	μV	f=10Hz~100kHz	Fig.3
Minimum I/O voltage differential	V _d	-	2.0	-	V	I _o =1A	Fig.4
Bias current	I _b	-	4.5	8.0	mA	I _o =0mA	Fig.5
Bias current change 1	I _{b1}	-	-	0.5	mA	I _o =5mA~1A	Fig.5
Bias current change 2	I _{b2}	-	-	0.8	mA	V _{IN} =10.5~25V	Fig.5
Peak output current	I _{o-P}	-	1.7	-	A	T _j =25°C	Fig.1
Output short-circuit current	I _{o-S}	-	0.6	-	A	V _{IN} =25V	Fig.6

<BA17809T / FP individual specifications> (unless otherwise noted, Ta=25°C, VIN=15V, Io=500mA)

Parameter	Symbol	Min.	Typ.	Max.	Unit	Conditions	Measurement circuit
Output voltage 1	V _{O1}	8.6	9.0	9.4	V	I _o =500mA	Fig.1
Output voltage 2	V _{O2}	8.55	-	9.45	V	V _{IN} =11.5~26V, I _o =5mA~1A	Fig.1
Input stability 1	Reg.L ₁	-	6	180	mV	V _{IN} =11.5~26V, I _o =500mA	Fig.1
Input stability 2	Reg.L ₂	-	4	90	mV	V _{IN} =13~19V, I _o =500mA	Fig.1
Ripple rejection ratio	R.R.	56	64	-	dB	e _{IN} =1V _{rms} , f=120Hz, I _o =100mA	Fig.2
Load regulation 1	Reg.L ₁	-	20	180	mV	I _o =5mA~1A	Fig.1
Load regulation 2	Reg.L ₂	-	8	90	mV	I _o =250~750mA	Fig.1
Temperature coefficient of output voltage	T _{CV_O}	-	-0.5	-	mV/°C	I _o =5mA, T _j =0~125°C	Fig.1
Output noise voltage	V _n	-	90	-	μV	f=10Hz~100kHz	Fig.3
Minimum I/O voltage differential	V _d	-	2.0	-	V	I _o =1A	Fig.4
Bias current	I _b	-	4.5	8.0	mA	I _o =0mA	Fig.5
Bias current change 1	I _{b1}	-	-	0.5	mA	I _o =5mA~1A	Fig.5
Bias current change 2	I _{b2}	-	-	0.8	mA	V _{IN} =11.5~26V	Fig.5
Peak output current	I _{o-P}	-	1.7	-	A	T _j =25°C	Fig.1
Output short-circuit current	I _{o-S}	-	0.3	-	A	V _{IN} =30V	Fig.6

Regulator ICs

<BA17810T / FP individual specifications> (unless otherwise noted, Ta=25°C, VIN=16V, Io=500mA)

Parameter	Symbol	Min.	Typ.	Max.	Unit	Conditions	Measurement circuit
Output voltage 1	VO1	9.6	10.0	10.4	V	Io=500mA	Fig.1
Output voltage 2	VO2	9.5	-	10.5	V	VIN=12.5~25V, Io=5mA~1A	Fig.1
Input stability 1	Reg.I1	-	7	200	mV	VIN=12.5~27V, Io=500mA	Fig.1
Input stability 2	Reg.I2	-	4	100	mV	VIN=14~20V, Io=500mA	Fig.1
Ripple rejection ratio	R.R.	55	64	-	dB	eIN=1Vrms, f=120Hz, Io=100mA	Fig.2
Load regulation 1	Reg.L1	-	21	200	mV	Io=5mA~1A	Fig.1
Load regulation 2	Reg.L2	-	8	90	mV	Io=250~750mA	Fig.1
Temperature coefficient of output voltage	TCVO	-	-0.5	-	mV/°C	Io=5mA, Tj=0~125°C	Fig.1
Output noise voltage	Vn	-	100	-	μV	f=10Hz~100kHz	Fig.3
Minimum I/O voltage differential	Vd	-	2.0	-	V	Io=1A	Fig.4
Bias current	Ib	-	4.5	8.0	mA	Io=0mA	Fig.5
Bias current change 1	Ib1	-	-	0.5	mA	Io=5mA~1A	Fig.5
Bias current change 2	Ib2	-	-	0.8	mA	VIN=12.5~27V	Fig.5
Peak output current	Io-P	-	1.7	-	A	Tj=25°C	Fig.1
Output short-circuit current	Ios	-	0.3	-	A	VIN=30V	Fig.6

<BA17812T / FP individual specifications> (unless otherwise noted, Ta=25°C, VIN=19V, Io=500mA)

Parameter	Symbol	Min.	Typ.	Max.	Unit	Conditions	Measurement circuit
Output voltage 1	VO1	11.5	12.0	12.5	V	Io=500mA	Fig.1
Output voltage 2	VO2	11.4	-	12.6	V	VIN=15~27V, Io=5mA~1A	Fig.1
Input stability 1	Reg.I1	-	8	240	mV	VIN=14.5~30V, Io=500mA	Fig.1
Input stability 2	Reg.I2	-	5	120	mV	VIN=16~22V, Io=500mA	Fig.1
Ripple rejection ratio	R.R.	55	63	-	dB	eIN=1Vrms, f=120Hz, Io=100mA	Fig.2
Load regulation 1	Reg.L1	-	23	240	mV	Io=5mA~1A	Fig.1
Load regulation 2	Reg.L2	-	10	120	mV	Io=250~750mA	Fig.1
Temperature coefficient of output voltage	TCVO	-	-0.5	-	mV/°C	Io=5mA, Tj=0~125°C	Fig.1
Output noise voltage	Vn	-	110	-	μV	f=10Hz~100kHz	Fig.3
Minimum I/O voltage differential	Vd	-	2.0	-	V	Io=1A	Fig.4
Bias current	Ib	-	4.5	8.0	mA	Io=0mA	Fig.5
Bias current change 1	Ib1	-	-	0.5	mA	Io=5mA~1A	Fig.5
Bias current change 2	Ib2	-	-	0.8	mA	VIN=14.5~30V	Fig.5
Peak output current	Io-P	-	1.7	-	A	Tj=25°C	Fig.1
Output short-circuit current	Ios	-	0.3	-	A	VIN=30V	Fig.6

Regulator ICs

<BA17815T / FP individual specifications> (unless otherwise noted, Ta=25°C, VIN=23V, Io=500mA)

Parameter	Symbol	Min.	Typ.	Max.	Unit	Conditions	Measurement circuit
Output voltage 1	Vo1	14.4	15.0	15.6	V	Io=500mA	Fig.1
Output voltage 2	Vo2	14.25	-	15.75	V	VIN=17.5~30V, Io=5mA~1A	Fig.1
Input stability 1	Reg.L1	-	9	300	mV	VIN=17.5~30V, Io=500mA	Fig.1
Input stability 2	Reg.L2	-	5	150	mV	VIN=20~26V, Io=500mA	Fig.1
Ripple rejection ratio	R.R.	54	62	-	dB	eIN=1Vrms, f=120Hz, Io=100mA	Fig.2
Load regulation 1	Reg.L1	-	27	300	mV	Io=5mA~1A	Fig.1
Load regulation 2	Reg.L2	-	10	150	mV	Io=250~750mA	Fig.1
Temperature coefficient of output voltage	Tcvo	-	-0.6	-	mV/°C	Io=5mA, Tj=0~125°C	Fig.1
Output noise voltage	Vn	-	125	-	μV	f=10Hz~100kHz	Fig.3
Minimum I/O voltage differential	Vd	-	2.0	-	V	Io=1A	Fig.4
Bias current	Ib	-	4.5	8.0	mA	Io=0mA	Fig.5
Bias current change 1	Ib1	-	-	0.5	mA	Io=5mA~1A	Fig.5
Bias current change 2	Ib2	-	-	0.8	mA	VIN=17.5~30V	Fig.5
Peak output current	Io-P	-	1.7	-	A	Tj=25°C	Fig.1
Output short-circuit current	Ios	-	0.3	-	A	VIN=30V	Fig.6

<BA17818T / FP individual specifications> (unless otherwise noted, Ta=25°C, VIN=27V, Io=500mA)

Parameter	Symbol	Min.	Typ.	Max.	Unit	Conditions	Measurement circuit
Output voltage 1	Vo1	17.3	18.0	18.7	V	Io=500mA	Fig.1
Output voltage 2	Vo2	17.1	-	18.9	V	VIN=21~33V, Io=5mA~1A	Fig.1
Input stability 1	Reg.L1	-	10	360	mV	VIN=21~33V, Io=500mA	Fig.1
Input stability 2	Reg.L2	-	5	180	mV	VIN=24~33V, Io=500mA	Fig.1
Ripple rejection ratio	R.R.	55	61	-	dB	eIN=1Vrms, f=120Hz, Io=100mA	Fig.2
Load regulation 1	Reg.L1	-	30	360	mV	Io=5mA~1A	Fig.1
Load regulation 2	Reg.L2	-	12	180	mV	Io=250~750mA	Fig.1
Temperature coefficient of output voltage	Tcvo	-	-0.6	-	mV/°C	Io=5mA, Tj=0~125°C	Fig.1
Output noise voltage	Vn	-	140	-	μV	f=10Hz~100kHz	Fig.3
Minimum I/O voltage differential	Vd	-	2.0	-	V	Io=1A	Fig.4
Bias current	Ib	-	4.5	8.0	mA	Io=0mA	Fig.5
Bias current change 1	Ib1	-	-	0.5	mA	Io=5mA~1A	Fig.5
Bias current change 2	Ib2	-	-	0.8	mA	VIN=21~33V	Fig.5
Peak output current	Io-P	-	1.7	-	A	Tj=25°C	Fig.1
Output short-circuit current	Ios	-	0.3	-	A	VIN=30V	Fig.6

Regulator ICs

<BA17820T / FP individual specifications> (unless otherwise noted, Ta=25°C, VIN=29V, Io=500mA)

Parameter	Symbol	Min.	Typ.	Max.	Unit	Conditions	Measurement circuit
Output voltage 1	Vo1	19.2	20.0	20.8	V	Io=500mA	Fig.1
Output voltage 2	Vo2	19.0	-	21.0	V	VIN=23~33V, Io=5mA~1A	Fig.1
Input stability 1	Reg.l1	-	12	400	mV	VIN=23~33V, Io=500mA	Fig.1
Input stability 2	Reg.l2	-	7	200	mV	VIN=26~32V, Io=500mA	Fig.1
Ripple rejection ratio	R.R.	53	60	-	dB	eIN=1Vrms, f=120Hz, Io=100mA	Fig.2
Load regulation 1	Reg.L1	-	32	400	mV	Io=5mA~1A	Fig.1
Load regulation 2	Reg.L2	-	14	200	mV	Io=250~750mA	Fig.1
Temperature coefficient of output voltage	Tcvo	-	-0.7	-	mV/°C	Io=5mA, Tj =0~125°C	Fig.1
Output noise voltage	Vn	-	150	-	μV	f=10Hz~100kHz	Fig.3
Minimum I/O voltage differential	Vd	-	2.0	-	V	Io=1A	Fig.4
Bias current	Ib	-	4.5	8.0	mA	Io=0mA	Fig.5
Bias current change 1	Ib1	-	-	0.5	mA	Io=5mA~1A	Fig.5
Bias current change 2	Ib2	-	-	0.8	mA	VIN=23~33V	Fig.5
Peak output current	Io-P	-	1.7	-	A	Tj=25°C	Fig.1
Output short-circuit current	Ios	-	0.3	-	A	VIN=30V	Fig.6

<BA17824T / FP individual specifications> (unless otherwise noted, Ta=25°C, VIN=33V, Io=500mA)

Parameter	Symbol	Min.	Typ.	Max.	Unit	Conditions	Measurement circuit
Output voltage 1	Vo1	23.0	24.0	25.0	V	Io=500mA	Fig.1
Output voltage 2	Vo2	22.8	-	25.2	V	VIN=27~33V, Io=5mA~1A	Fig.1
Input stability 1	Reg.l1	-	15	480	mV	VIN=27~33V, Io=500mA	Fig.1
Input stability 2	Reg.l2	-	10	240	mV	VIN=30~33V, Io=500mA	Fig.1
Ripple rejection ratio	R.R.	50	58	-	dB	eIN=1Vrms, f=120Hz, Io=100mA	Fig.2
Load regulation 1	Reg.L1	-	37	480	mV	Io=5mA~1A	Fig.1
Load regulation 2	Reg.L2	-	15	240	mV	Io=250~750mA	Fig.1
Temperature coefficient of output voltage	Tcvo	-	-0.7	-	mV/°C	Io=5mA, Tj =0~125°C	Fig.1
Output noise voltage	Vn	-	180	-	μV	f=10Hz~100kHz	Fig.3
Minimum I/O voltage differential	Vd	-	2.0	-	V	Io=1A	Fig.4
Bias current	Ib	-	4.7	8.0	mA	Io=0mA	Fig.5
Bias current change 1	Ib1	-	-	0.5	mA	Io=5mA~1A	Fig.5
Bias current change 2	Ib2	-	-	0.8	mA	VIN=27~33V	Fig.5
Peak output current	Io-P	-	1.7	-	A	Tj=25°C	Fig.1
Output short-circuit current	Ios	-	0.3	-	A	VIN=30V	Fig.6

Regulator ICs

●Measurement circuits

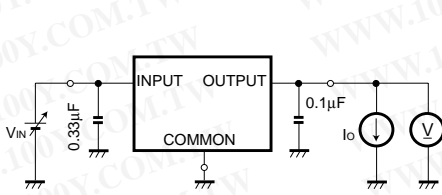
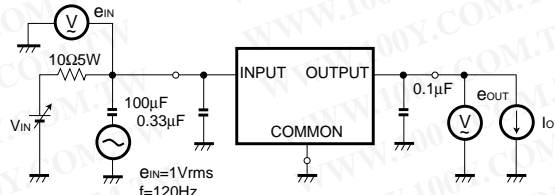

Fig. 1 Measurement circuit for output voltage, input stability, load regulation, temperature coefficient of output voltage



Ripple rejection ratio $R.R. = 20 \log \left(\frac{|e_{IN}|}{|e_{OUT}|} \right)$

Fig. 2 Measurement circuit for ripple rejection ratio

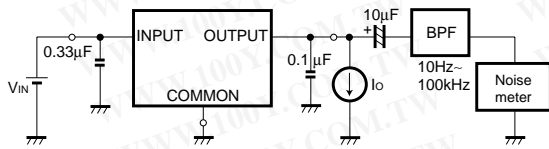

Fig. 3 Measurement circuit for output noise voltage

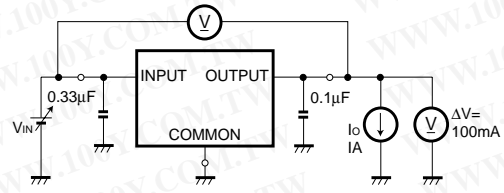

Fig. 4 Measurement circuit for Minimum I/O voltage differential

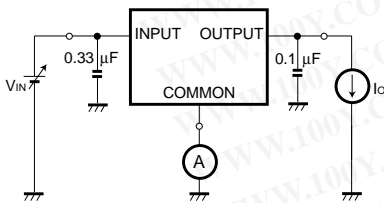

Fig. 5 Measurement circuit for bias current and bias current change

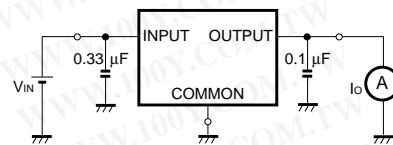

Fig. 6 Measurement circuit for output short-circuit current

●Electrical characteristic curves

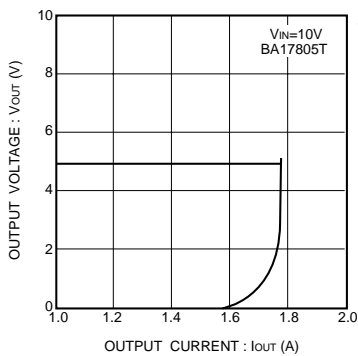

Fig. 7 Current limit characteristics

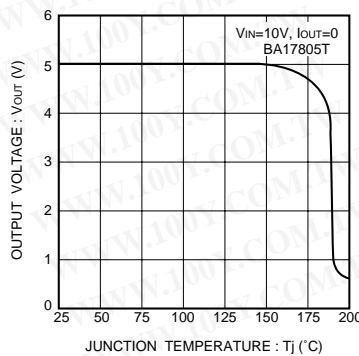

Fig. 8 Thermal cutoff circuit characteristics

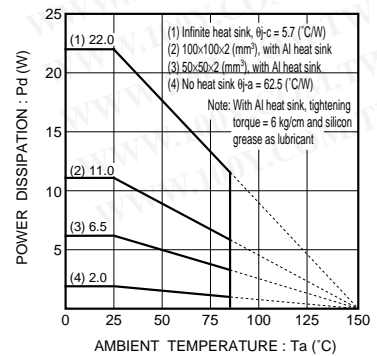

Fig. 9 T_a - power dissipation characteristics (TO220)

Regulator ICs

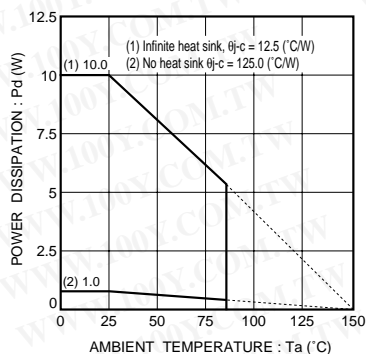

Fig.10 Ta - power dissipation characteristics (TO252-3)

●Operation notes

- (1) Although the circuit examples included in this handbook are highly recommendable for general use, you should be thoroughly familiar with circuit characteristics as they relate to your own use conditions. If you intend to change the number of external circuits, leave an ample margin, taking into account discrepancies in both static and dynamic characteristics of external parts and Rohm ICs. In addition, please be advised that Rohm cannot provide complete assurance regarding patent rights.
- (2) Operating power supply voltage
When operating within the normal voltage range and within the ambient operating temperature range, most circuit functions are guaranteed. The rated values can not be guaranteed for the electrical characteristics, but there are no sudden changes of the characteristics within these ranges.
- (3) Power dissipation
Heat attenuation characteristics are noted on a separate page and can be used as a guide in judging power dissipation.
If these ICs are used in such a way that the allowable power dissipation level is exceeded, an increase in the chip temperature could cause a reduction in the current capability or could otherwise adversely affect the performance of the IC. Make sure a sufficient margin is allowed so that the allowable power dissipation value is not exceeded.
- (4) Preventing oscillation in output and using bypass capacitors
Always use a capacitor between the output pins and the GND to prevent fluctuation in the output and to prevent oscillation between the output pins and the GND of the application's input (V_{IN} 0.1 μ F should be used.)
Changes in the temperature and other factors can cause the value of the capacitor to change, and this can cause oscillation. To prevent this, we recommend using a tantalum capacitor which has minimal changes in nominal capacitance.
Also, we recommend adding a bypass capacitor of about 0.33 μ F between the input pin and the GND, as close to the pin as possible.
- (5) Thermal overload circuit
A built-in thermal overload circuit prevents damage from overheating. When the thermal circuit is activated, the various outputs are in the OFF state. When the temperature drops back to a constant level, the circuit is restored.
- (6) Internal circuits could be damaged if there are modes in which the electric potential of the application's input (V_{IN}) and GND are the opposite of the electric potential of the various outputs. Use of a diode or other such bypass path is recommended.
- (7) Although the manufacture of this product includes rigorous quality assurance procedures, it may be damaged if absolute maximum ratings for voltage or operating temperature are exceeded. When damage has occurred, special modes (such as short circuit mode or open circuit mode) cannot be specified. If it is possible that such special modes may be needed, please consider using a fuse or some other mechanical safety measure.
- (8) When used within a strong magnetic field, be aware that there is a slight possibility of malfunction.

BA178OOT / FP series

Regulator ICs

●External dimensions (Units : mm)

