



勝特力材料 886-3-5753170
 勝特力电子(上海) 86-21-54151736
 勝特力电子(深圳) 86-755-83298787
[Http://www.100y.com.tw](http://www.100y.com.tw)

STPR1620CG STPR1620CT

ULTRA-FAST RECOVERY RECTIFIER DIODES

MAIN PRODUCTS CHARACTERISTICS

$I_{F(AV)}$	2 x 8 A
V_{RRM}	200 V
$T_j(max)$	150°C
$V_F(max)$	0.99 V
$t_{rr}(max)$	30 ns

FEATURES

- SUITED FOR SMPS
- LOW LOSSES
- LOW FORWARD AND REVERSE RECOVERY TIME
- HIGH SURGE CURRENT CAPABILITY

DESCRIPTION

Low cost dual center tap rectifier suited for Switched Mode Power Supplies and high frequency DC to DC converters. Packaged in D²PAK or TO-220AB, this device is intended for use in low voltage, high frequency inverters, free wheeling and polarity protection applications.

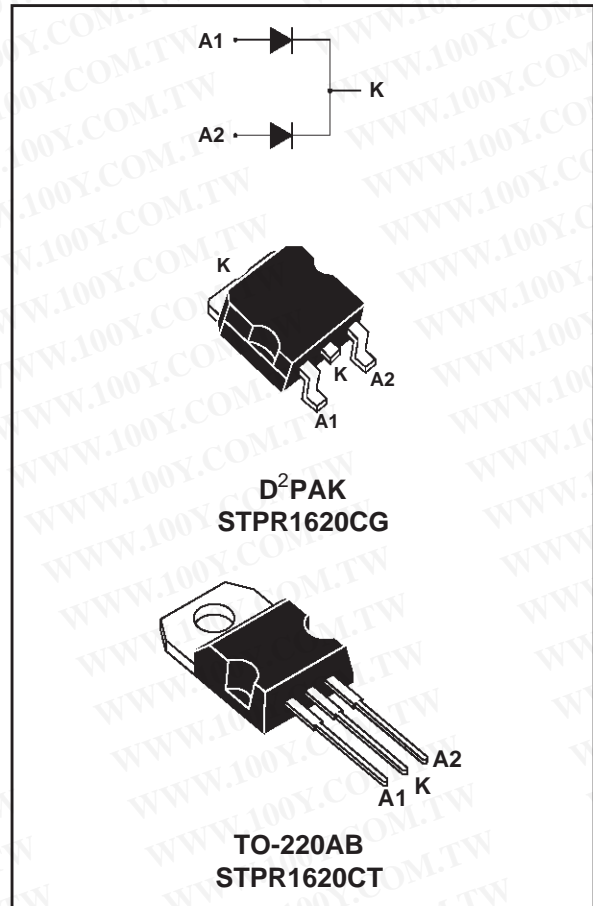

ABSOLUTE RATINGS (limiting values, per diode)

Symbol	Parameter		Value	Unit
V_{RRM}	Repetitive peak reverse voltage		200	V
$I_{F(RMS)}$	RMS forward current		20	A
$I_{F(AV)}$	Average forward current $\delta = 0.5$	$T_c = 120^\circ\text{C}$ Per diode Per device	8 16	A
I_{FSM}	Surge non repetitive forward current	$t_p = 10\text{ms}$ sinusoidal	80	A
T_{stg}	Storage temperature range		- 65 to + 150	°C
T_j	Maximum operating junction temperature		150	°C

STPR1620CG / STPS1620CT

THERMAL RESISTANCES

Symbol	Parameter		Value	Unit
R _{th(j-c)}	Junction to case	Per diode	3.0	°C/W
		Total	1.8	°C/W
R _{th(c)}		Coupling	0.6	°C/W

When the diodes 1 and 2 are used simultaneously :

$$\Delta T_j(\text{diode 1}) = P(\text{diode 1}) \times R_{th(j-c)}(\text{Per diode}) + P(\text{diode 2}) \times R_{th(c)}$$

STATIC ELECTRICAL CHARACTERISTICS

Symbol	Test conditions		Min.	Typ.	Max.	Unit
I _R *	T _j = 25°C	V _R = V _{RRM}			50	μA
	T _j = 100°C			0.2	0.6	mA
V _F **	T _j = 125°C	I _F = 8 A		0.8	0.99	V
	T _j = 125°C	I _F = 16 A		0.95	1.20	
	T _j = 25°C	I _F = 16 A			1.25	

Pulse test : * tp = 5 ms, δ < 2 %

** tp = 380 μs, δ < 2 %

To evaluate the conduction losses use the following equation :

$$P = 0.78 \times I_{F(AV)} + 0.026 \times I_{F(RMS)}^2$$

RECOVERY CHARACTERISTICS

Symbol	Test conditions		Min.	Typ.	Max.	Unit
trr	T _j = 25°C	I _F = 0.5A I _R = 1A			30	ns
tfr	T _j = 25°C	I _F = 3A V _{FR} = 1.1 x V _F max		20		ns
V _{FP}	T _j = 25°C	I _F = 3A		3		V

勝特力材料 886-3-5753170
 勝特力电子(上海) 86-21-54151736
 勝特力电子(深圳) 86-755-83298787
[Http://www.100y.com.tw](http://www.100y.com.tw)

Fig. 1: Average forward power dissipation versus average forward current (per diode).

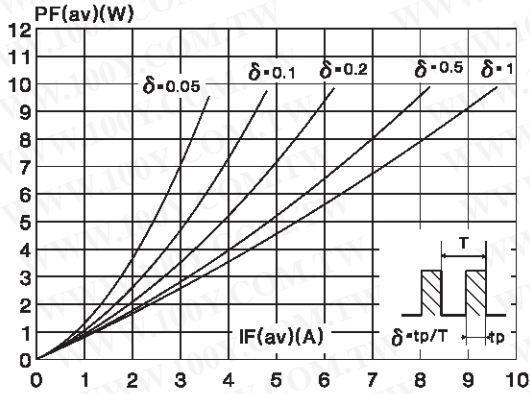

Fig. 2: Peak current versus form factor (per diode).

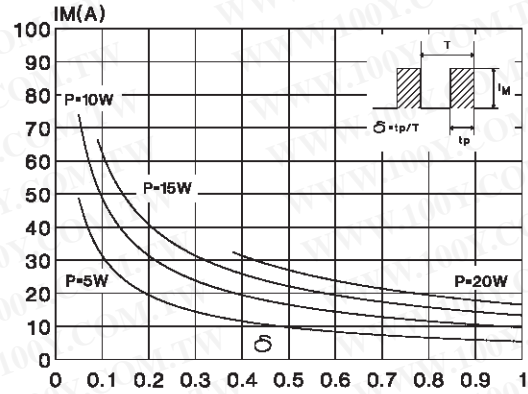

Fig. 3: Average current versus ambient temperature ($\delta : 0.5$, per diode).

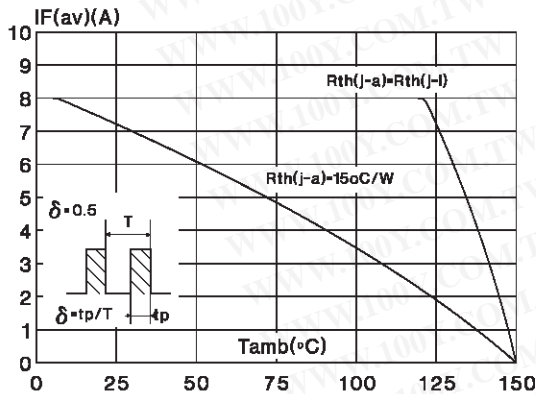

Fig. 4: Non repetitive surge peak forward current versus overload duration (maximum values, per diode).

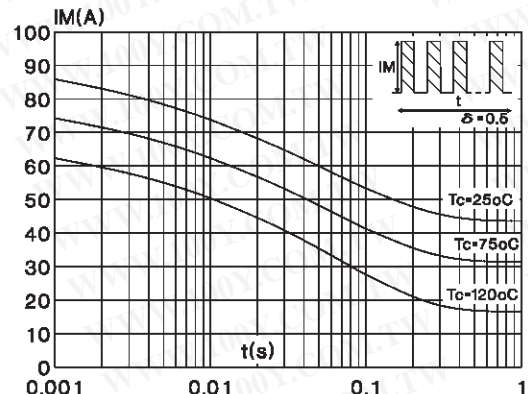

Fig. 5: Relative variation of thermal transient impedance junction to case versus pulse duration (per diode).

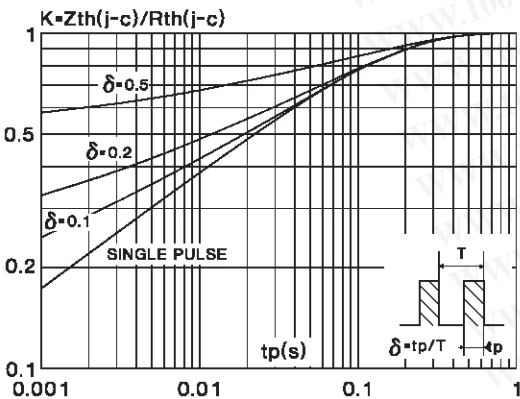
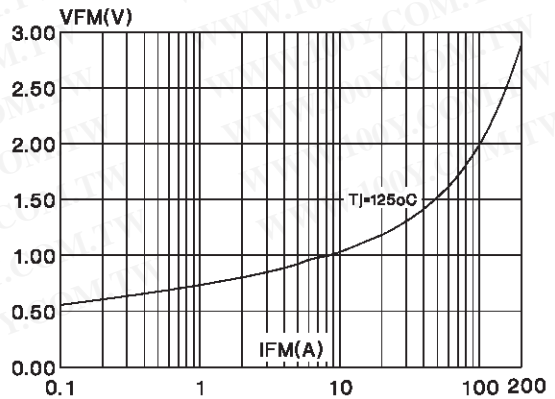

Fig. 6: Forward voltage drop versus forward current (maximum values, per diode).



STPR1620CG / STPS1620CT

Fig. 7: Junction capacitance versus reverse voltage applied (typical values, per diode).

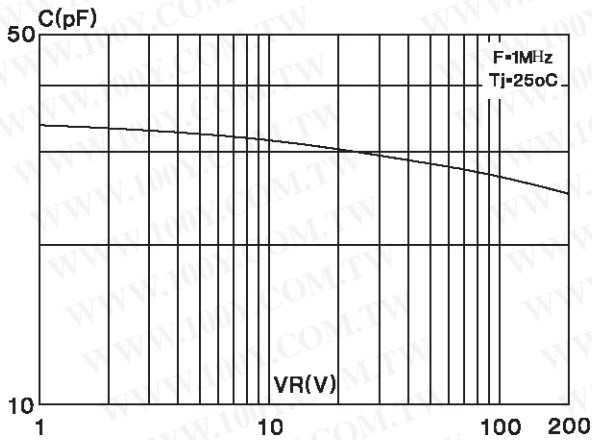

Fig. 8: Recovery charges versus dI_F/dt (per diode).

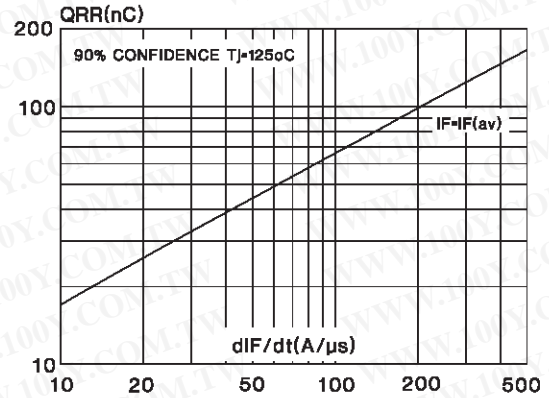

Fig. 9: Peak reverse current versus dI_F/dt (per diode).

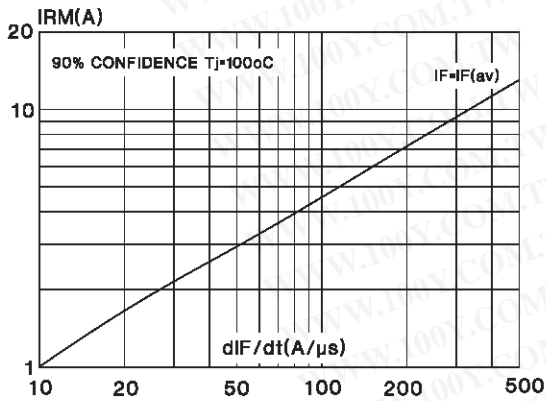
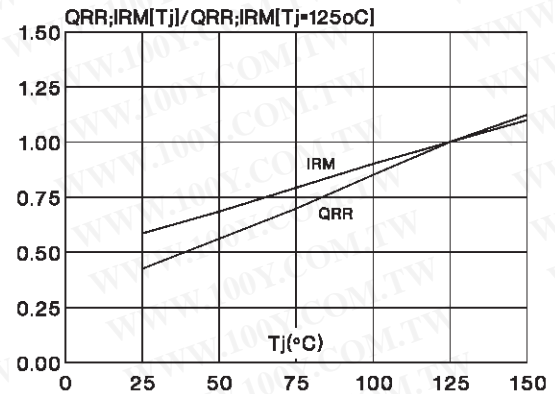
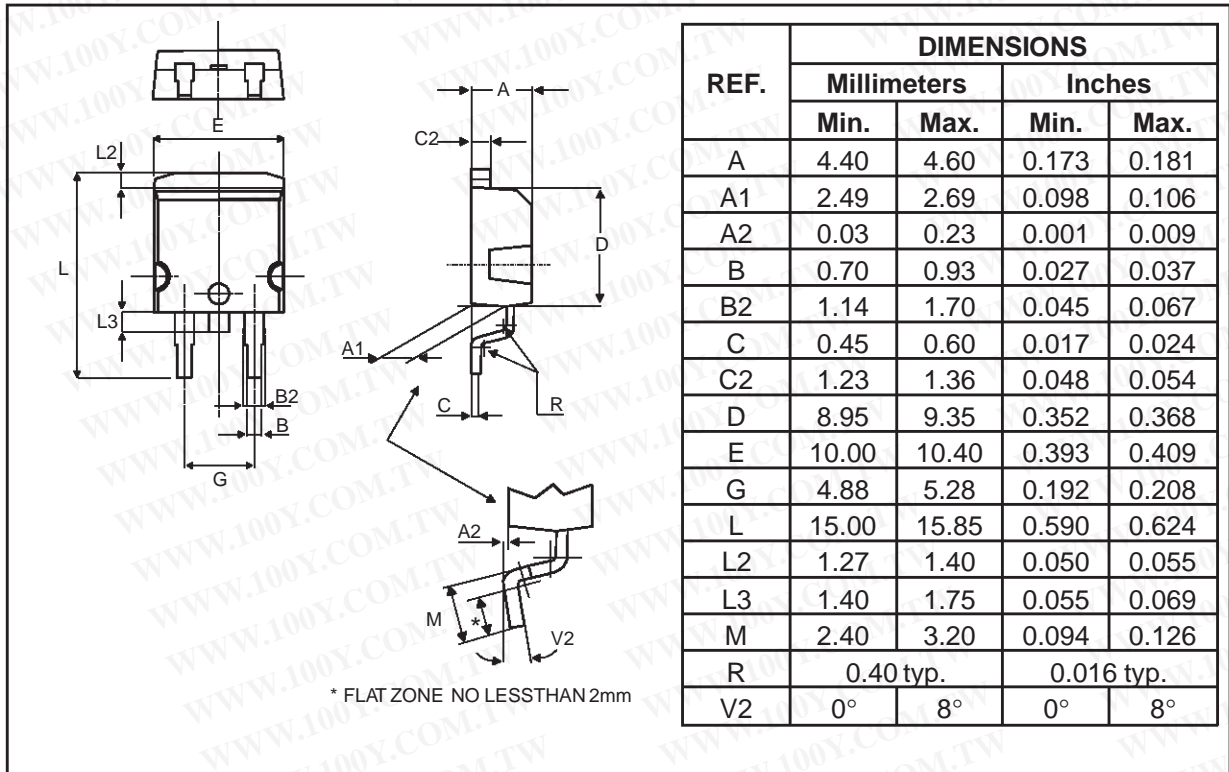

Fig. 10: Dynamic parameters versus junction temperature (per diode).



勝特力材料 886-3-5753170
 勝特力电子(上海) 86-21-54151736
 勝特力电子(深圳) 86-755-83298787
[Http://www.100y.com.tw](http://www.100y.com.tw)

PACKAGE MECHANICAL DATA
D²PAK (Plastic)



FOOT PRINT (in millimeters)

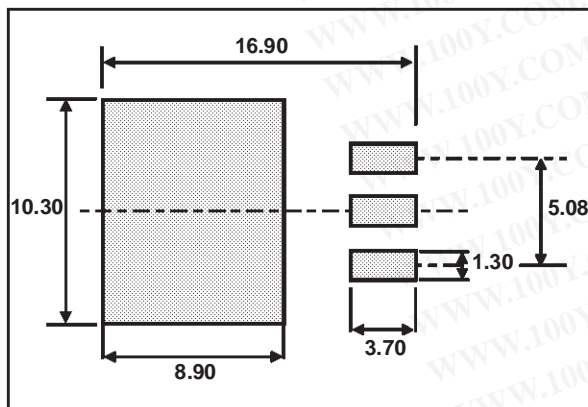

勝特力材料 886-3-5753170
 勝特力电子(上海) 86-21-54151736
 勝特力电子(深圳) 86-755-83298787
[Http://www.100y.com.tw](http://www.100y.com.tw)

STPR1620CG / STPS1620CT

PACKAGE MECHANICAL DATA
 TO-220AB (JEDEC outline)

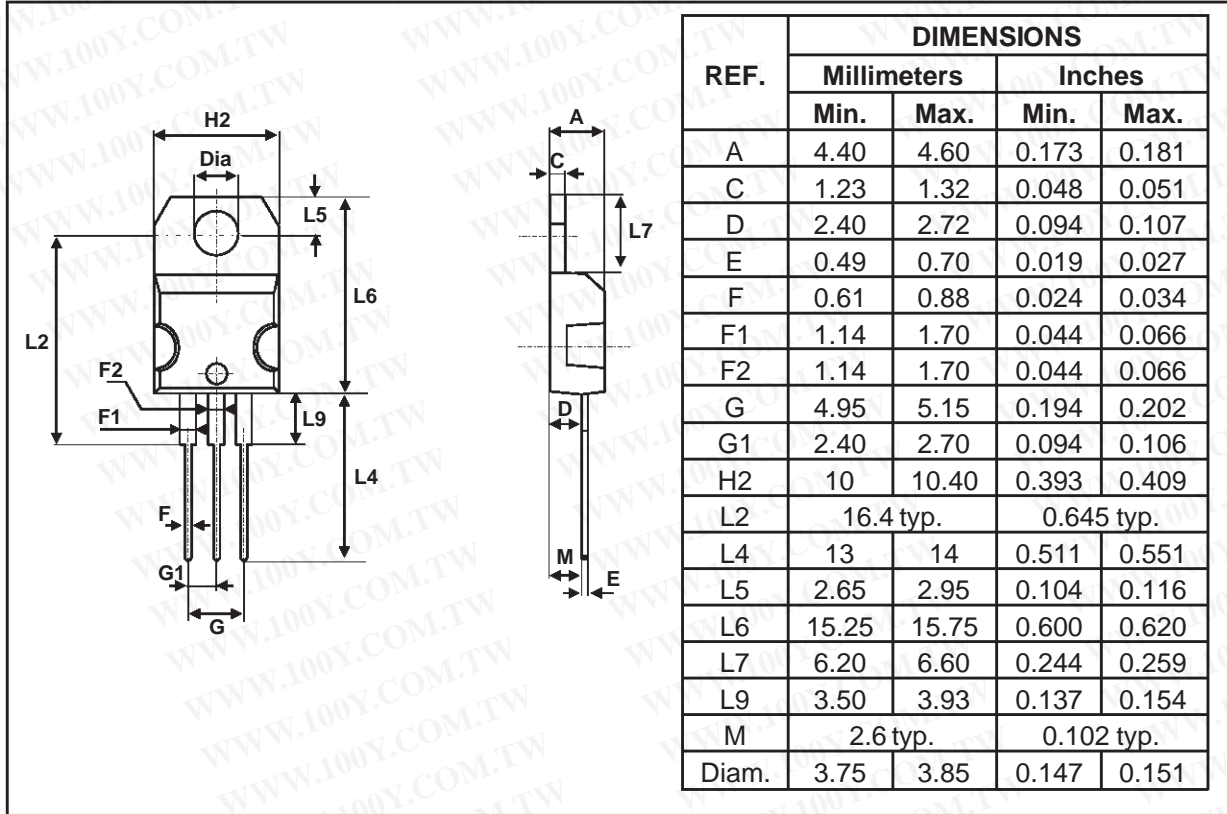

Ordering type	Marking	Package	Weight	Base qty	Delivery mode
STPR1620CT	STPR1620CT	TO-220AB	2.23g	50	Tube
STPR1620CG	STPR1620CG	D ² PAK	1.48g	50	Tube
STPR1620CG-TR	STPR1620CG	D ² PAK	1.48g	1000	Tape & reel

- Cooling method : by conduction (C)
- Recommended torque value : 0.55N.m.
- Maximum torque value : 0.7N.m.
- Epoxy meets UL94,V0

Information furnished is believed to be accurate and reliable. However, STMicroelectronics assumes no responsibility for the consequences of use of such information nor for any infringement of patents or other rights of third parties which may result from its use. No license is granted by implication or otherwise under any patent or patent rights of STMicroelectronics. Specifications mentioned in this publication are subject to change without notice. This publication supersedes and replaces all information previously supplied. STMicroelectronics products are not authorized for use as critical components in life support devices or systems without express written approval of STMicroelectronics.

The ST logo is a registered trademark of STMicroelectronics

© 1999 STMicroelectronics - Printed in Italy - All rights reserved.

STMicroelectronics GROUP OF COMPANIES

Australia - Brazil - China - Finland - France - Germany - Hong Kong - India - Italy - Japan - Malaysia
 Malta - Morocco - Singapore - Spain - Sweden - Switzerland - United Kingdom - U.S.A.

<http://www.st.com>