



STPS15L60CB

POWER SCHOTTKY RECTIFIER

MAIN PRODUCTS CHARACTERISTICS

| | |
|-------------|-----------|
| $I_{F(AV)}$ | 2 x 7.5 A |
| V_{RRM} | 60 V |
| $T_j(max)$ | 150 °C |
| $V_F(max)$ | 0.52 V |

FEATURES AND BENEFITS

- NEGLIGIBLE SWITCHING LOSSES
- LOW FORWARD VOLTAGE DROP
- LOW THERMAL RESISTANCE
- AVALANCHE CAPABILITY SPECIFIED

DESCRIPTION

Dual center tab Schottky rectifier suited for Switch Mode Power Supply and high frequency DC to DC converters.

Package in DPAK, this device is intended for use in low voltage, high frequency inverters, free-wheeling and polarity protection applications.

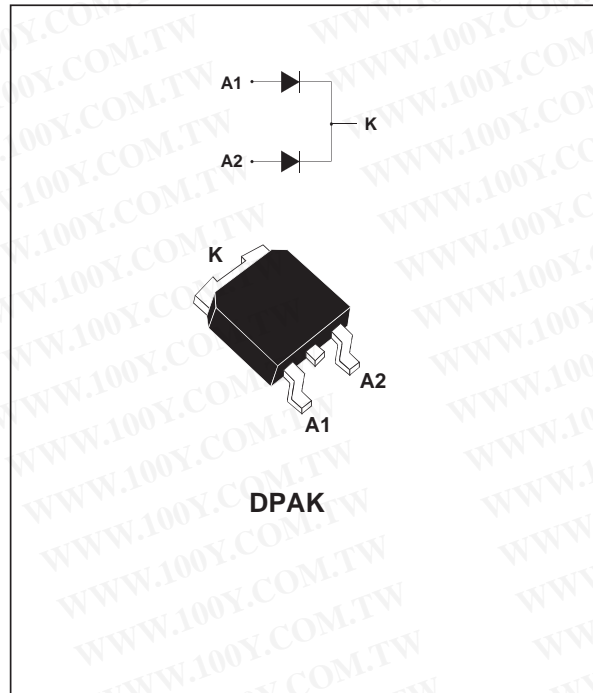

ABSOLUTE RATINGS (limiting values, per diode)

| Symbol | Parameter | | Value | Unit |
|--------------|--|--|------------------|------------------|
| V_{RRM} | Repetitive peak reverse voltage | | 60 | V |
| $I_{F(RMS)}$ | RMS forward current | | 10 | A |
| $I_{F(AV)}$ | Average forward current | $T_c = 135^\circ\text{C}$ $\delta = 0.5$ | Per diode 7.5 | A |
| | | | Per device 15 | |
| I_{FSM} | Surge non repetitive forward current | $t_p = 10$ ms sinusoidal | 75 | A |
| I_{RRM} | Peak repetitive reverse current | $t_p = 2 \mu\text{s}$ square $F = 1\text{kHz}$ | 1 | A |
| P_{ARM} | Repetitive peak avalanche power | $t_p = 1 \mu\text{s}$ $T_j = 25^\circ\text{C}$ | 3700 | W |
| T_{stg} | Storage temperature range | | - 65 to + 175 | °C |
| T_j | Maximum operating junction temperature * | | 150 | °C |
| dV/dt | Critical rate of rise reverse voltage | | 10000 | V/ μs |

* : $\frac{dP_{tot}}{dT_j} < \frac{1}{R_{th(j-a)}}$ thermal runaway condition for a diode on its own heatsink

勝特力材料 886-3-5753170
 勝特力电子(上海) 86-21-54151736
 勝特力电子(深圳) 86-755-83298787
[Http://www.100y.com.tw](http://www.100y.com.tw)

STPS15L60CB

THERMAL RESISTANCES

| Symbol | Parameter | Value | Unit |
|----------------------|------------------|-----------|------|
| R _{th(j-c)} | Junction to case | Per diode | 4 |
| | | Total | 2.4 |
| R _{th(c)} | Coupling | 0.7 | °C/W |

When the diodes 1 and 2 are used simultaneously :

$$\Delta T_j(\text{diode 1}) = P(\text{diode 1}) \times R_{th(j-c)}(\text{Per diode}) + P(\text{diode 2}) \times R_{th(c)}$$

STATIC ELECTRICAL CHARACTERISTICS (per diode)

| Symbol | Parameter | Tests Conditions | Min. | Typ. | Max. | Unit |
|------------------|-------------------------|------------------------|-----------------------------------|------|------|------|
| I _R * | Reverse leakage current | T _j = 25°C | V _R = V _{RRM} | | 200 | μA |
| | | T _j = 125°C | | 45 | 60 | mA |
| V _F * | Forward voltage drop | T _j = 25°C | I _F = 7.5 A | | 0.62 | V |
| | | T _j = 125°C | I _F = 7.5 A | 0.52 | 0.57 | |
| | | T _j = 25°C | I _F = 12 A | | 0.76 | |
| | | T _j = 125°C | I _F = 12 A | 0.62 | 0.68 | |
| | | T _j = 25°C | I _F = 15 A | | 0.82 | |
| | | T _j = 125°C | I _F = 15 A | 0.66 | 0.72 | |

Pulse test : * t_p = 380 μs, δ < 2%

To evaluate the conduction losses use the following equation :

$$P = 0.32 \times I_{F(AV)} + 0.027 I_{F(RMS)}^2$$

Fig. 1: Conduction losses versus average current.

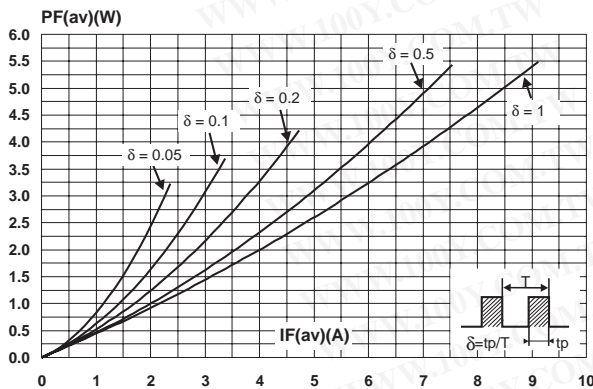

Fig. 3: Normalized avalanche power derating versus pulse duration.

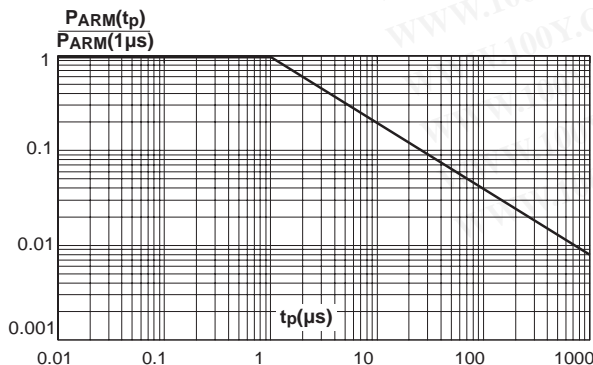

Fig. 2: Average forward current versus ambient temperature (δ = 0.5).

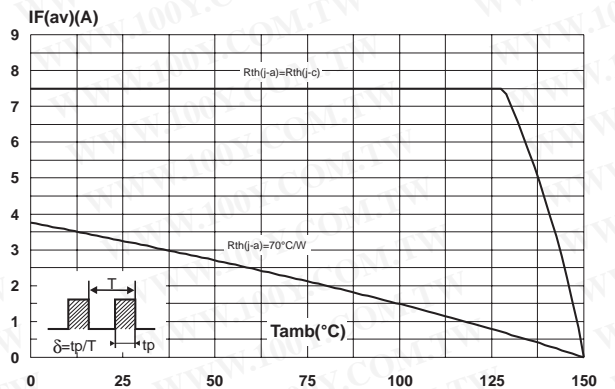

Fig. 4: Normalized avalanche power derating versus junction temperature.

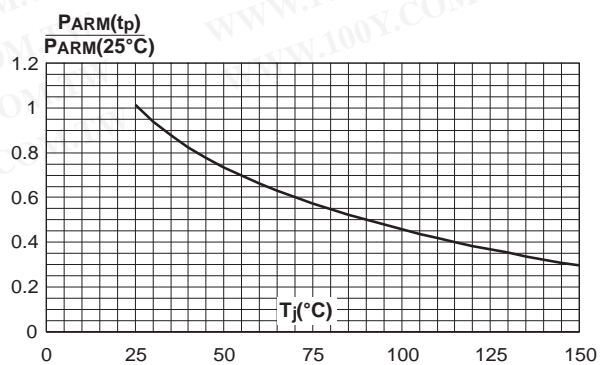

Fig. 5: Non repetitive surge peak forward current versus overload duration (maximum values).

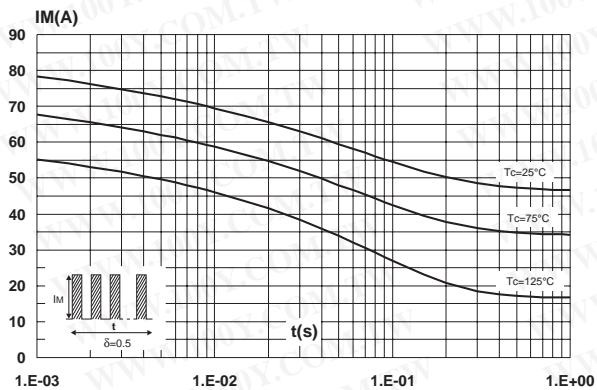

Fig. 6: Relative variation of thermal impedance junction to case versus pulse duration.

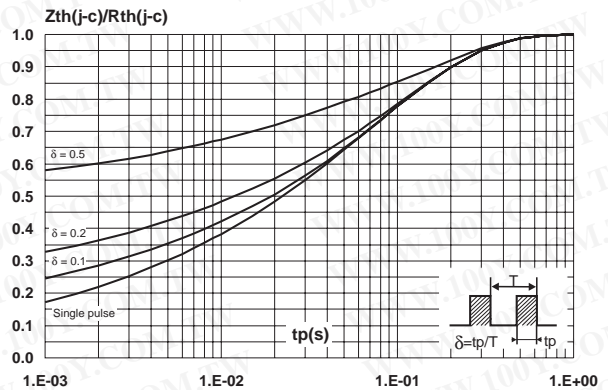

Fig. 7: Reverse leakage current versus reverse voltage applied (typical values).

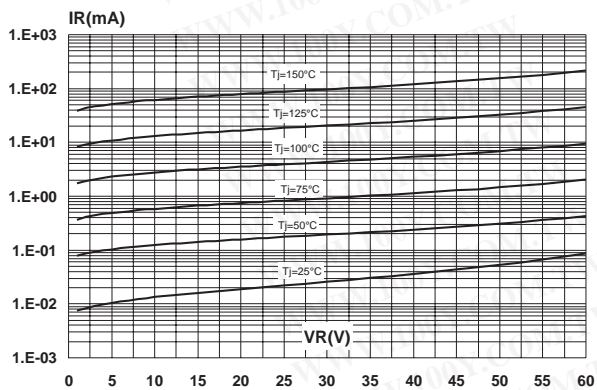

Fig. 8: Junction capacitance versus reverse voltage applied (typical values).

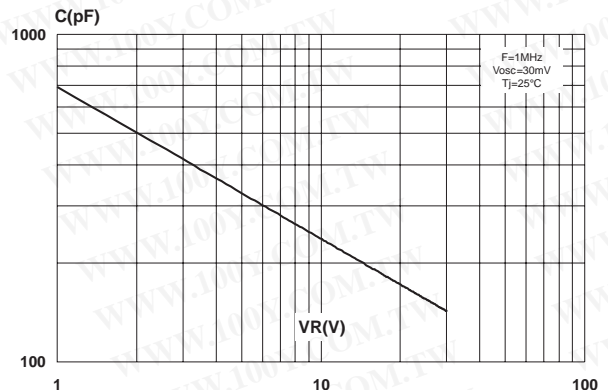

Fig. 9: Forward voltage drop versus forward current.

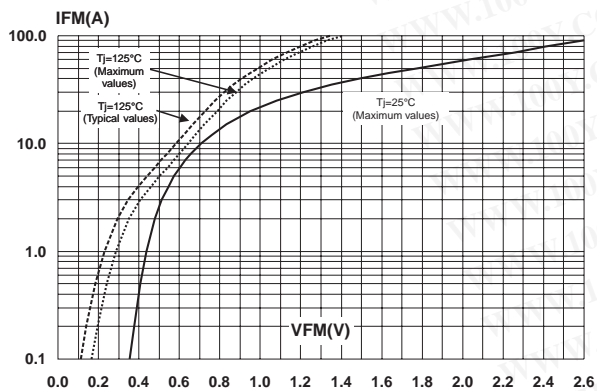
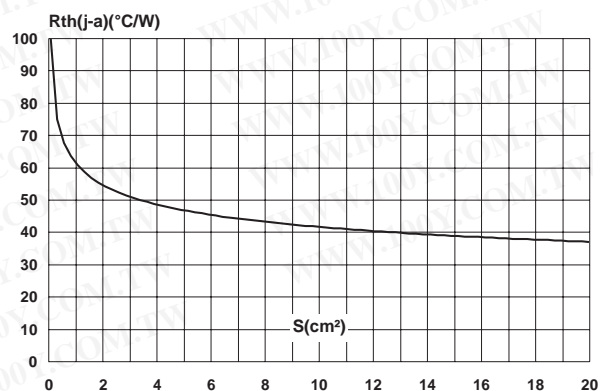

Fig. 10: Thermal resistance junction to ambient versus copper surface under tab (epoxy printed board FR4, Cu = 35μm).



勝特力材料 886-3-5753170
 勝特力电子(上海) 86-21-54151736
 勝特力电子(深圳) 86-755-83298787
[Http://www.100y.com.tw](http://www.100y.com.tw)

STPS15L60CB

PACKAGE MECHANICAL DATA DPAK

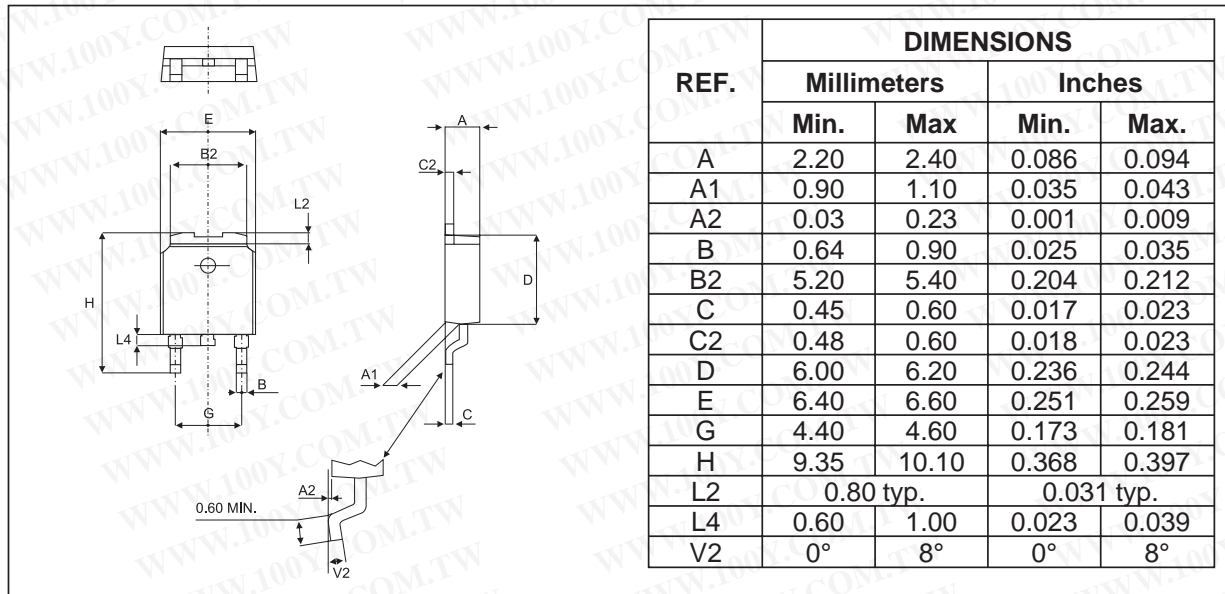

FOOTPRINT (dimensions in mm)

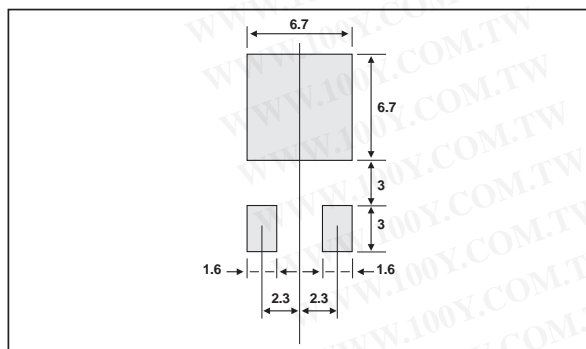

勝特力材料 886-3-5753170
 勝特力电子(上海) 86-21-54151736
 勝特力电子(深圳) 86-755-83298787
[Http://www.100y.com.tw](http://www.100y.com.tw)

| Ordering type | Marking | Package | Weight | Base qty | Delivery mode |
|----------------|---------|---------|--------|----------|---------------|
| STPS15L60CB | S15L60C | DPAK | 0.30 g | 75 | Tube |
| STPS15L60CB-TR | S15L60C | DPAK | 0.30 g | 2500 | Tape & reel |

■ EPOXY MEETS UL94,V0

Information furnished is believed to be accurate and reliable. However, STMicroelectronics assumes no responsibility for the consequences of use of such information nor for any infringement of patents or other rights of third parties which may result from its use. No license is granted by implication or otherwise under any patent or patent rights of STMicroelectronics. Specifications mentioned in this publication are subject to change without notice. This publication supersedes and replaces all information previously supplied. STMicroelectronics products are not authorized for use as critical components in life support devices or systems without express written approval of STMicroelectronics.

The ST logo is a registered trademark of STMicroelectronics

© 2003 STMicroelectronics - Printed in Italy - All rights reserved.

STMicroelectronics GROUP OF COMPANIES

Australia - Brazil - Canada - China - Finland - France - Germany
 Hong Kong - India - Israel - Italy - Japan - Malaysia - Malta - Morocco - Singapore
 Spain - Sweden - Switzerland - United Kingdom - United States.

<http://www.st.com>