



STPS16045TV

POWER SCHOTTKY RECTIFIER

MAIN PRODUCT CHARACTERISTICS

$I_{F(AV)}$	2 x 80 A
V_{RRM}	45 V
$T_j(\text{max})$	150 °C
$V_F(\text{max})$	0.69 V

FEATURES AND BENEFITS

- VERY SMALL CONDUCTION LOSSES
- NEGLIGIBLE SWITCHING LOSSES
- EXTREMELY FAST SWITCHING
- LOW THERMAL RESISTANCE
- INSULATED PACKAGE:
 Insulating voltage = 2500 V_(RMS)
 Capacitance = 45 pF

DESCRIPTION

Dual power Schottky rectifier suited for Switched Mode Power Supplies and high frequency DC to DC converters.

Packaged in ISOTOP, this device is especially intended for use in low voltage, high frequency inverters, free wheeling and polarity protection applications.

ABSOLUTE RATINGS (limiting values, per diode)

Symbol	Parameter		Value	Unit
V_{RRM}	Repetitive peak reverse voltage		45	V
$I_{F(RMS)}$	RMS forward current		125	A
$I_{F(AV)}$	Average forward current	$T_c = 75^\circ\text{C}$ $\delta = 0.5$	Per diode: 80 Per device: 160	A
I_{FSM}	Surge non repetitive forward current	$t_p = 10 \text{ ms}$ sinusoidal	900	A
I_{RRM}	Repetitive peak reverse current	$t_p = 2 \mu\text{s}$ square $F = 1 \text{ kHz}$	2	A
I_{RSM}	Non repetitive peak reverse current	$t_p = 100 \mu\text{s}$ square	5	A
T_{stg}	Storage temperature range		- 55 to + 150	°C
T_j	Maximum operating junction temperature *		150	°C
dV/dt	Critical rate of rise of reverse voltage		10000	V/ μs

* : $\frac{dP_{tot}}{dT_j} < \frac{1}{R_{th(j-a)}}$ thermal runaway condition for a diode on its own heatsink

ISOTOP is a trademark of STMicroelectronics

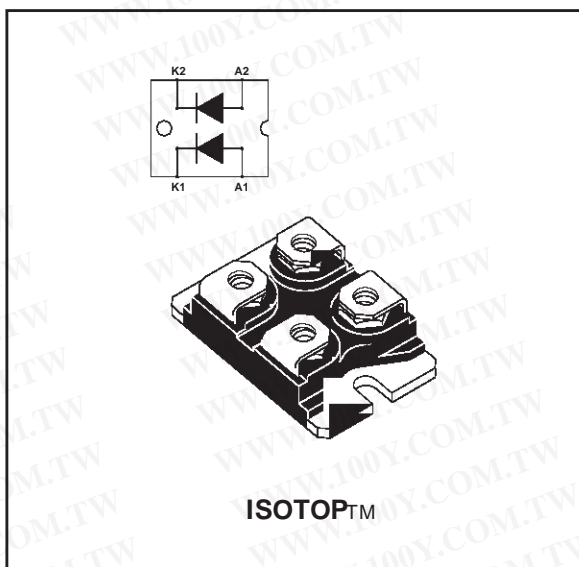

STPS16045TV

THERMAL RESISTANCES

Symbol	Parameter	Value	Unit
R _{th(j-c)}	Junction to case	Per diode	1
		Total	0.55
R _{th(c)}	Coupling	0.1	

When the diodes 1 and 2 are used simultaneously :

$$\Delta T_j(\text{diode } 1) = P(\text{diode } 1) \times R_{th(j-c)} + P(\text{diode } 2) \times R_{th(c)}$$

STATIC ELECTRICAL CHARACTERISTICS (per diode)

Symbol	Parameter	Tests Conditions	Min.	Typ.	Max.	Unit	
I _R *	Reverse leakage current	T _j = 25°C	V _R = V _{RRM}		1	mA	
		T _j = 125°C		43	150		
V _F *	Forward voltage drop	T _j = 125°C	I _F = 80 A		0.62	0.69	V
		T _j = 25°C		I _F = 160 A		0.95	
		T _j = 125°C		I _F = 160 A		0.8	

Pulse test : * t_p = 380 μs, δ < 2%

To evaluate the conduction losses use the following equation :

$$P = 0.48 \times I_{F(AV)} + 0.00262 \times I_{F(RMS)}^2$$

Fig. 1: Average forward power dissipation versus average forward current (per diode).

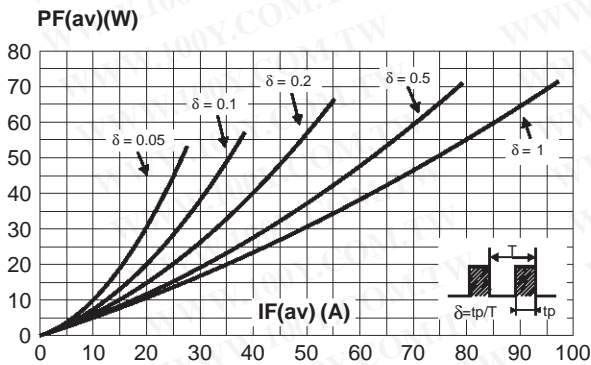
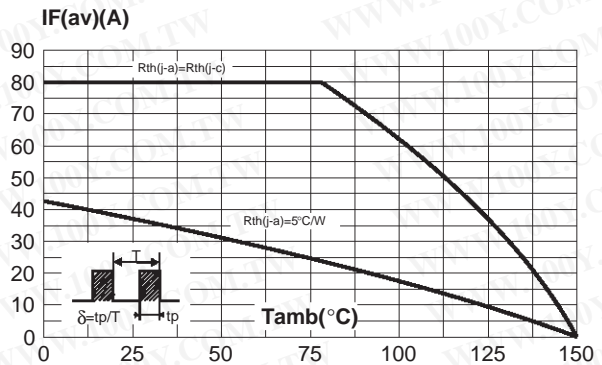

Fig. 2: Average current versus case temperature (δ = 0.5, per diode).



勝特力材料 886-3-5753170
 勝特力电子(上海) 86-21-54151736
 勝特力电子(深圳) 86-755-83298787
[Http://www.100y.com.tw](http://www.100y.com.tw)

Fig. 3: Non repetitive surge peak forward current versus overload duration (maximum values, per diode).

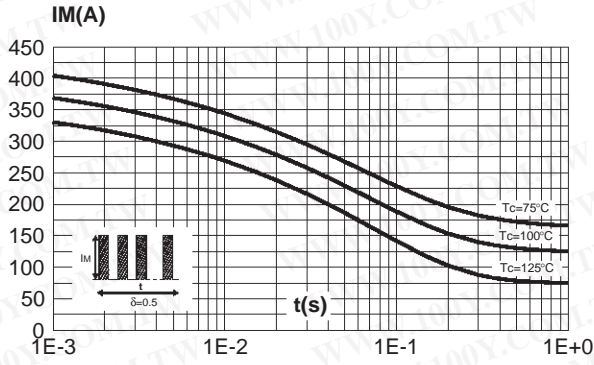

Fig. 4: Relative variation of thermal transient impedance junction to case versus pulse duration (per diode).

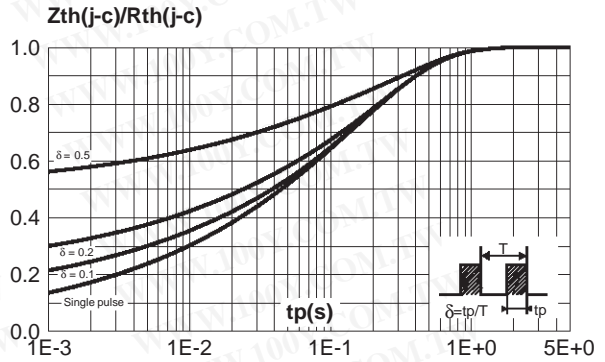

Fig. 5: Reverse leakage current versus reverse voltage applied (typical values, per diode).

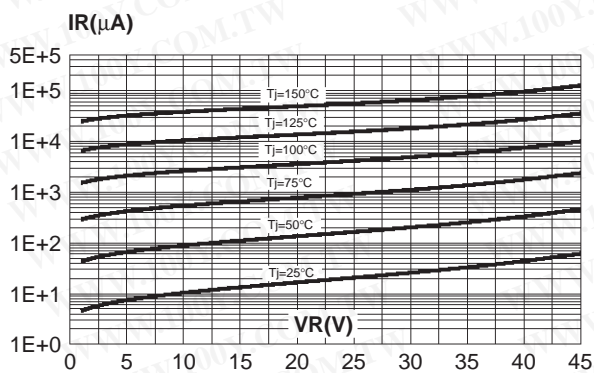

Fig. 6: Junction capacitance versus reverse voltage applied (typical values, per diode).

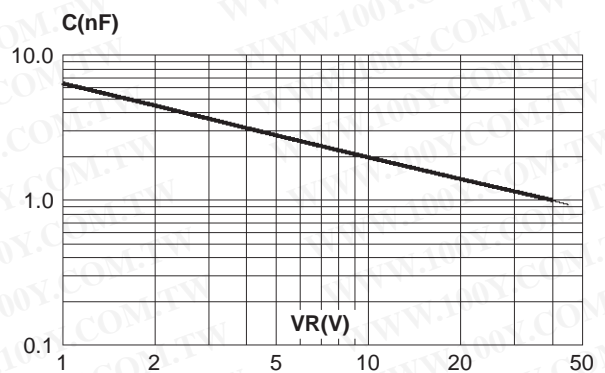
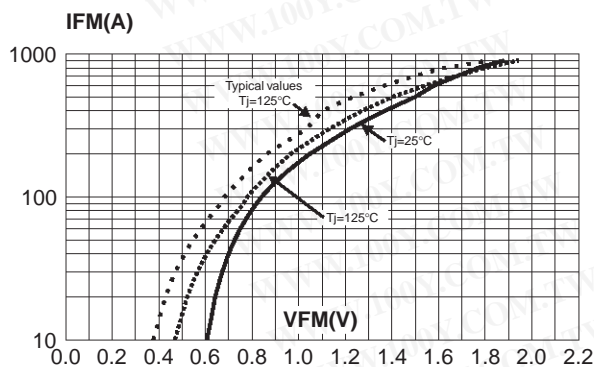

Fig. 7: Forward voltage drop versus forward current (maximum values, per diode).



勝特力材料 886-3-5753170
 勝特力电子(上海) 86-21-54151736
 勝特力电子(深圳) 86-755-83298787
[Http://www.100y.com.tw](http://www.100y.com.tw)

PACKAGE MECHANICAL DATA
 ISOTOP

REF.	DIMENSIONS			
	Millimeters		Inches	
	Min.	Max.	Min.	Max.
A	11.80	12.20	0.465	0.480
A1	8.90	9.10	0.350	0.358
B	7.8	8.20	0.307	0.323
C	0.75	0.85	0.030	0.033
C2	1.95	2.05	0.077	0.081
D	37.80	38.20	1.488	1.504
D1	31.50	31.70	1.240	1.248
E	25.15	25.50	0.990	1.004
E1	23.85	24.15	0.939	0.951
E2	24.80 typ.		0.976 typ.	
G	14.90	15.10	0.587	0.594
G1	12.60	12.80	0.496	0.504
G2	3.50	4.30	0.138	0.169
F	4.10	4.30	0.161	0.169
F1	4.60	5.00	0.181	0.197
P	4.00	4.30	0.157	0.69
P1	4.00	4.40	0.157	0.173
S	30.10	30.30	1.185	1.193

Type	Marking	Package	Weight	Base qty	Delivery mode
STPS16045TV	STPS16045TV	ISOTOP	28 g. without screws	10	Tube

- Cooling method: by conduction (C)
- Recommended torque value: 1.3 N.m.
- Maximum torque value: 1.5 N.m.
- Epoxy meets UL94,V0

Information furnished is believed to be accurate and reliable. However, STMicroelectronics assumes no responsibility for the consequences of use of such information nor for any infringement of patents or other rights of third parties which may result from its use. No license is granted by implication or otherwise under any patent or patent rights of STMicroelectronics. Specifications mentioned in this publication are subject to change without notice. This publication supersedes and replaces all information previously supplied. STMicroelectronics products are not authorized for use as critical components in life support devices or systems without express written approval of STMicroelectronics.

The ST logo is a registered trademark of STMicroelectronics

© 1999 STMicroelectronics - Printed in Italy - All rights reserved.

STMicroelectronics GROUP OF COMPANIES

Australia - Brazil - China - Finland - France - Germany - Hong Kong - India - Italy - Japan - Malaysia
 Malta - Morocco - Singapore - Spain - Sweden - Switzerland - United Kingdom - U.S.A.

<http://www.st.com>