



STTA506D/F/B

TURBOSWITCH™ ULTRA-FAST HIGH VOLTAGE DIODE

MAIN PRODUCTS CHARACTERISTICS

$I_{F(AV)}$	5A
V_{RRM}	600V
t_{rr} (typ)	20ns
V_F (max)	1.5V

FEATURES AND BENEFITS

- SPECIFIC TO "FREEWHEEL MODE" OPERATIONS: FREEWHEEL OR BOOSTER DIODE
- ULTRA-FAST AND SOFT RECOVERY
- VERY LOW OVERALL POWER LOSSES IN BOTH THE DIODE AND THE COMPANION TRANSISTOR
- HIGH FREQUENCY OPERATIONS
- INSULATED PACKAGE : ISOWATT220AC
 Electrical insulation : 2000VDC
 Capacitance < 12 pF

DESCRIPTION

The TURBOSWITCH is a very high performance series of ultra-fast high voltage power diodes from 600V to 1200V. TURBOSWITCH family, drastically cuts losses in both the diode and the associated switching IGBT or MOSFET in all "freewheel mode" operations

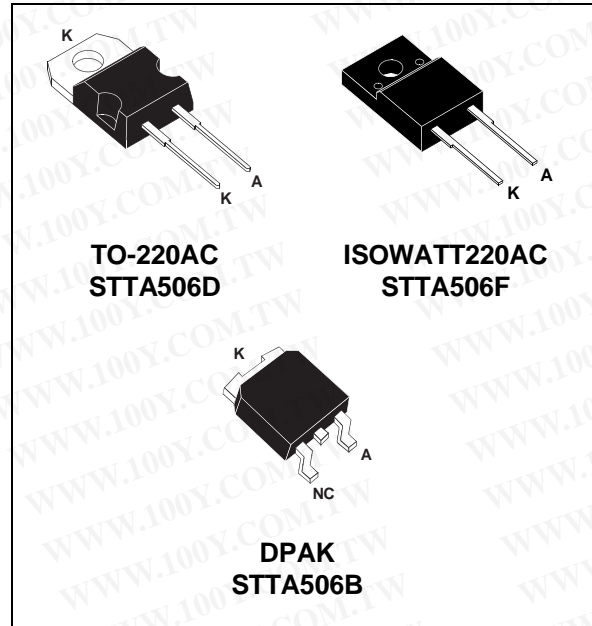

and is particularly suitable and efficient in motor control freewheel applications and in booster diode applications in power factor control circuitries. Packaged either in TO-220AC, ISOWATT220AC or in DPAK, these 600V devices are particularly intended for use on 240V domestic mains.

ABSOLUTE RATINGS (limiting values)

Symbol	Parameter	Value	Unit
V_{RRM}	Repetitive peak reverse voltage	600	V
V_{RSM}	Non repetitive peak reverse voltage	600	V
$I_{F(RMS)}$	RMS forward current	TO-220AC ISOWATT220AC	20 A
		DPAK	10 A
I_{FRM}	Repetitive peak forward current	$t_p=5\mu s$ F=5kHz square	65 A
I_{FSM}	Surge non repetitive forward current	$t_p=10$ ms sinusoidal	55 A
T_j	Maximum operating junction temperature	150	°C
T_{stg}	Storage temperature range	-65 to 150	°C

TM : TURBOSWITCH is a trademark of STMicroelectronics

STTA506D/F/B

THERMAL AND POWER DATA

Symbol	Parameter	Test conditions		Value	Unit
R _{th(j-c)}	Junction to case	TO-220AC / DPAK		3.5	°C/W
		ISOWATT220AC		6.0	
P ₁	Conduction power dissipation • I _{F(AV)} = 5A δ = 0.5	TO-220AC / DPAK	T _c = 118°C	9	W
		ISOWATT220AC	T _c = 96°C		
P _{max}	Total power dissipation P _{max} = P ₁ + P ₃ (P ₃ = 10% P ₁)	TO-220AC / DPAK	T _c = 115°C	10	W
		ISOWATT220AC	T _c = 90°C		

STATIC ELECTRICAL CHARACTERISTICS

Symbol	Parameter	Test conditions		Min	Typ	Max	Unit
V _F *	Forward voltage drop	I _F = 5A	T _j = 25°C		1.25	1.75	V
			T _j = 125°C			1.5	V
I _R **	Reverse leakage current	V _R = 0.8 x V _{RRM}	T _j = 25°C		0.75	100	μA
			T _j = 125°C			2	mA
V _{to}	Threshold voltage	I _p < 3.I _{AV}	T _j = 125°C			1.15	V
rd	Dynamic resistance					70	mΩ

Test pulse : * tp = 380 μs, δ < 2%
 ** tp = 5 ms, δ < 2%

To evaluate the maximum conduction losses use the following equation :
 $P = V_{to} \times I_{F(AV)} + r_d \times I_{F(RMS)}^2$

DYNAMIC ELECTRICAL CHARACTERISTICS

TURN-OFF SWITCHING

Symbol	Parameter	Test conditions	Min	Typ	Max	Unit
t _{rr}	Reverse recovery time	T _j = 25°C I _F = 0.5 A I _R = 1A I _{rr} = 0.25A I _F = 1 A dI _F /dt = -50A/μs V _R = 30V		20	50	ns
I _{RM}	Maximum reverse recovery current	T _j = 125°C V _R = 400V I _F = 5A dI _F /dt = -40 A/μs dI _F /dt = -500 A/μs		11	3.0	A
S factor	Softness factor	T _j = 125°C V _R = 400V I _F = 5A dI _F /dt = -500 A/μs		0.55		-

TURN-ON SWITCHING

Symbol	Parameter	Test conditions	Min	Typ	Max	Unit
t _{fr}	Forward recovery time	T _j = 25°C I _F = 5 A, dI _F /dt = 40 A/μs measured at 1.1 × V _{Fmax}			500	ns
V _{Fp}	Peak forward voltage	T _j = 25°C I _F = 5A, dI _F /dt = 40 A/μs			10	V

Fig. 1: Switching OFF losses versus di/dt .

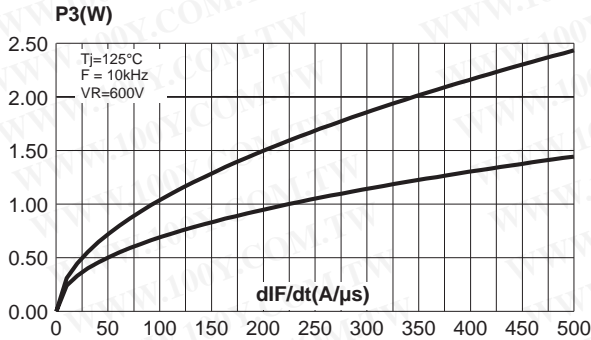

Fig. 2: Forward voltage drop versus forward current.

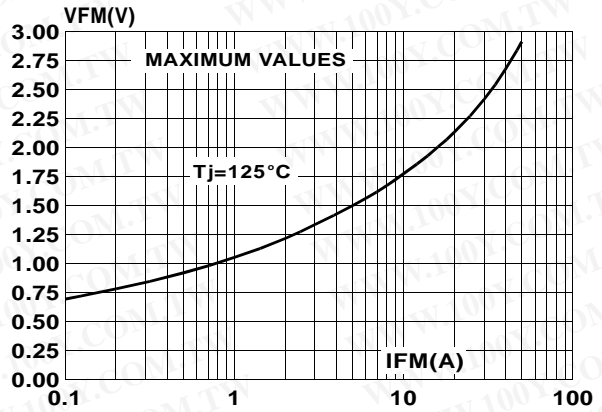

Fig. 3: Peak reverse recovery current versus di/dt .

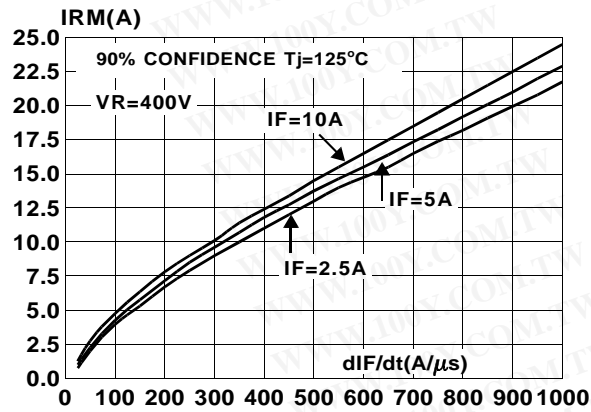

Fig. 4: Reverse recovery time versus di/dt .

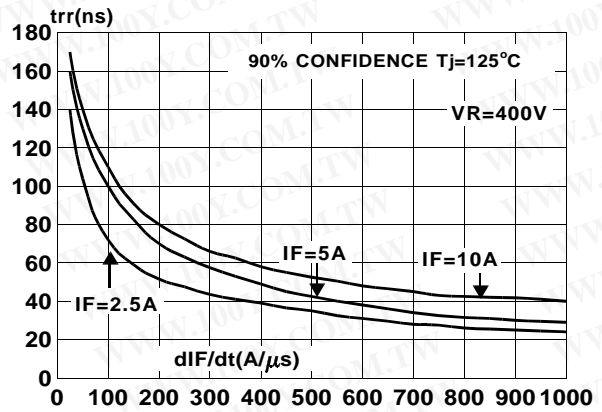

Fig. 5: Softness factor (t_b/t_a) versus di/dt .

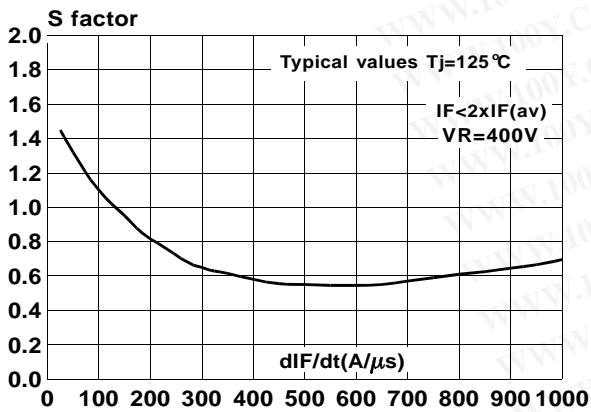
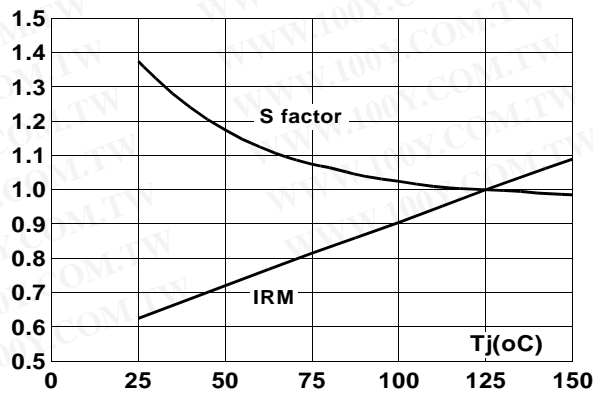

Fig. 6: Relative variation of dynamic parameters versus junction temperature (reference $T_j = 125^\circ\text{C}$).



STTA506D/F/B

Fig. 7: Transient peak forward voltage versus di_F/dt .

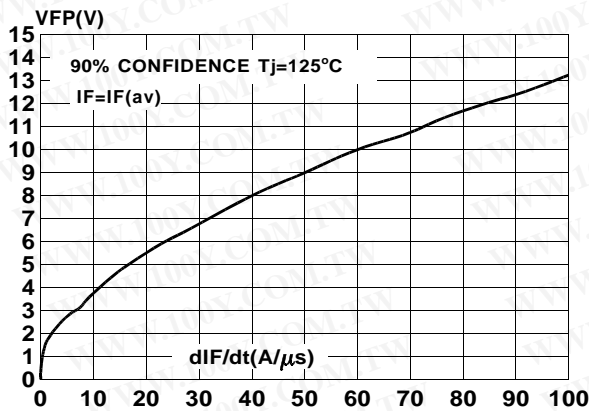

Fig. 8: Forward recovery time versus di_F/dt .

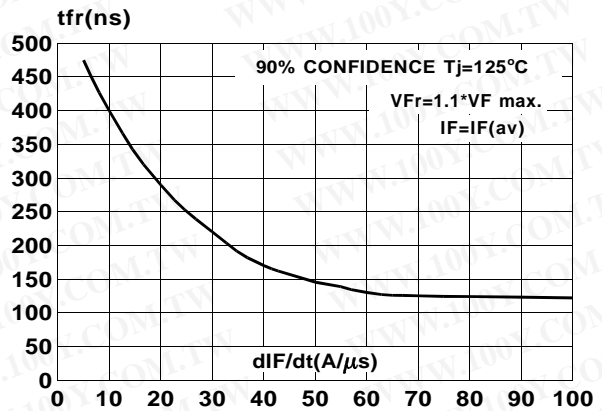

Fig. 9: Relative variation of thermal transient impedance junction to case versus pulse duration (TO-220AC and DPAK).

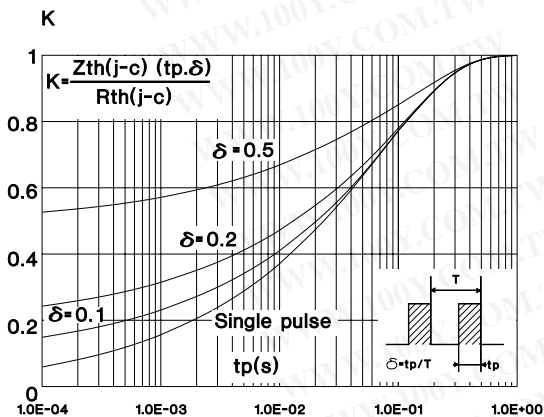
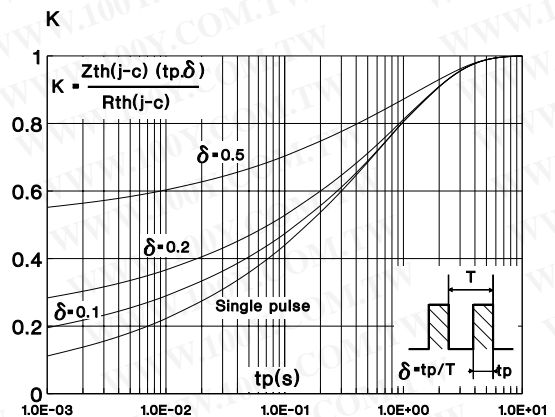

Fig. 10: Relative variation of thermal transient impedance junction to case versus pulse duration (ISOWATT220AC).



APPLICATION DATA

The TURBOSWITCH is especially designed to provide the lowest overall power losses in any "FREEWHEEL Mode" application (Fig.A) considering both the diode and the companion transistor, thus optimizing the overall performance in the end application.

The way of calculating the power losses is given below:

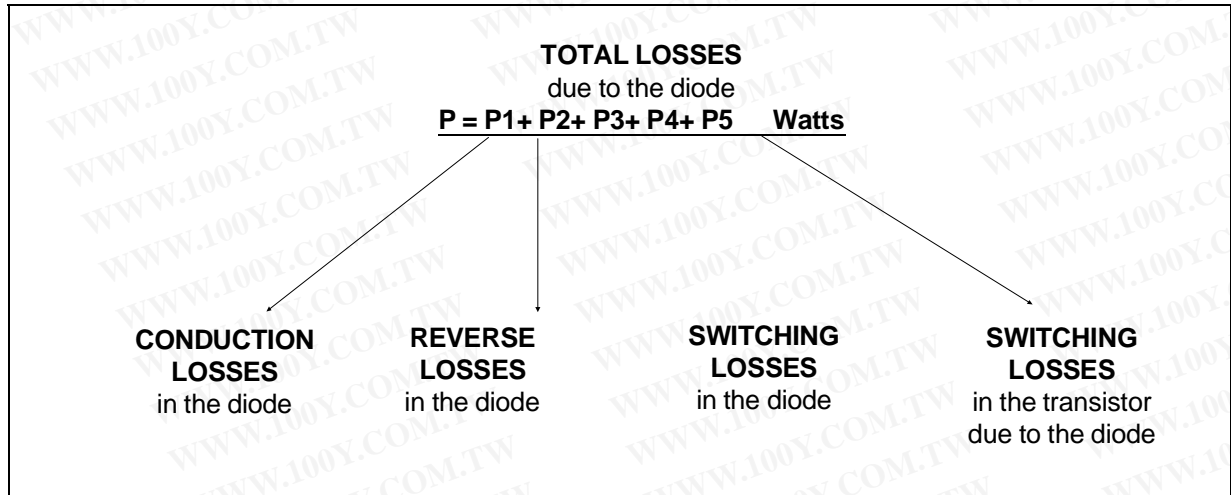
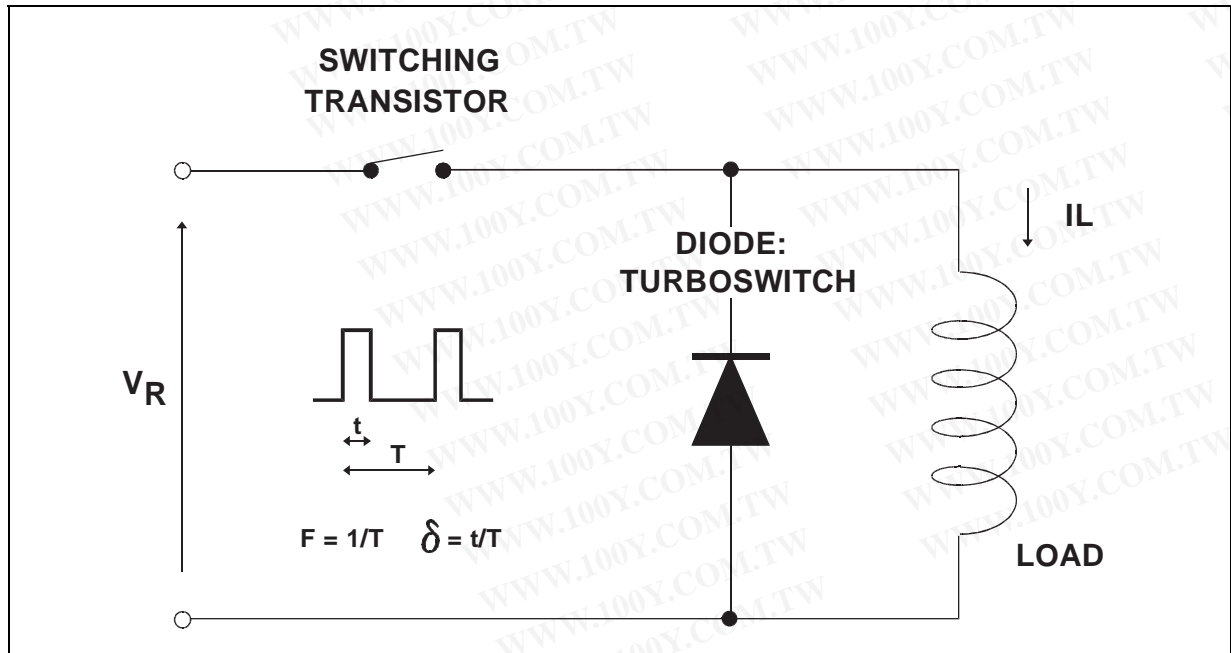

Fig. A : "FREEWHEEL" MODE



STTA506D/F/B

APPLICATION DATA (Cont'd)

Fig. B : STATIC CHARACTERISTICS

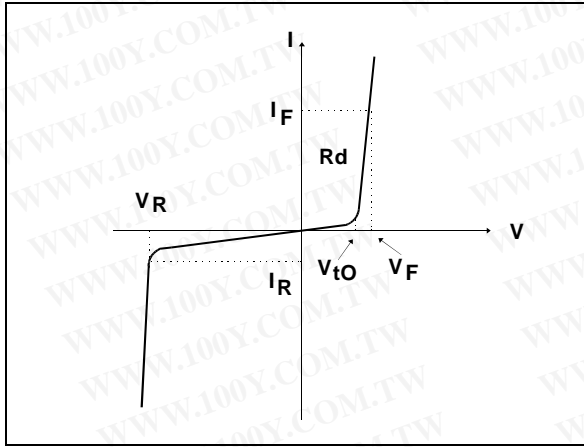

Conduction losses :

$$P1 = V_{t0} \cdot I_F(AV) + R_d \cdot I_F^2(RMS)$$

Reverse losses :

$$P2 = V_R \cdot I_R \cdot (1 - \delta)$$

Fig. C : TURN-OFF CHARACTERISTICS

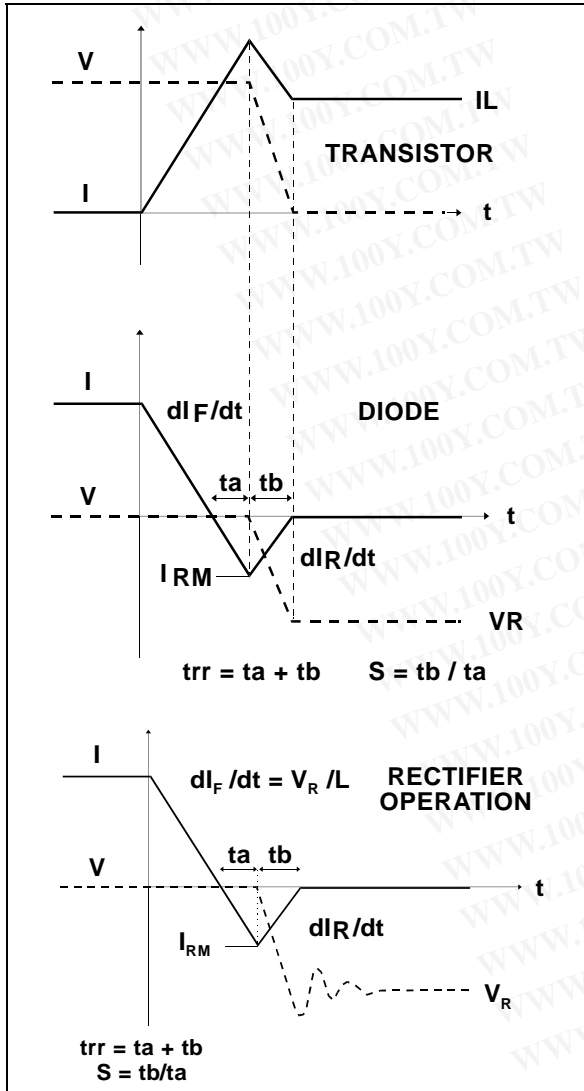

Turn-on losses :

(in the transistor, due to the diode)

$$P5 = \frac{V_R \times I_{RM}^2 \times (3 + 2 \times S) \times F}{6 \times dl_F/dt} + \frac{V_R \times I_{RM} \times I_L \times (S + 2) \times F}{2 \times dl_F/dt}$$

Turn-off losses (in the diode) :

$$P3 = \frac{V_R \times I_{RM}^2 \times S \times F}{6 \times dl_F/dt}$$

P3 and P5 are suitable for power MOSFET and IGBT

APPLICATION DATA (Cont'd)

Fig. D : TURN-ON CHARACTERISTICS

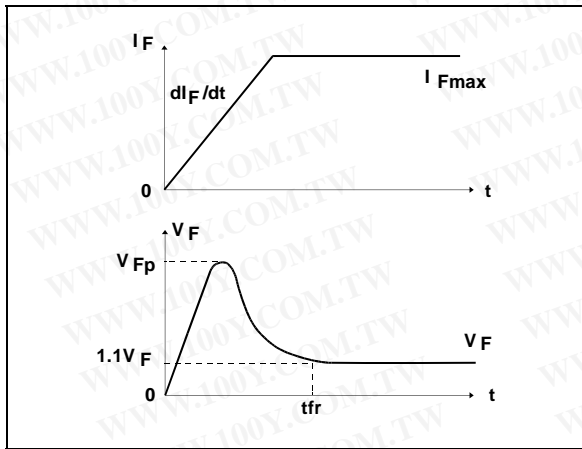

Turn-on losses :

$$P_4 = 0.4 (V_{FP} - V_F) \cdot I_{Fmax} \cdot t_{tr} \cdot F$$

勝特力材料 886-3-5753170
 勝特力电子(上海) 86-21-54151736
 勝特力电子(深圳) 86-755-83298787
[Http://www.100y.com.tw](http://www.100y.com.tw)

STTA506D/F/B

PACKAGE MECHANICAL DATA DPAK

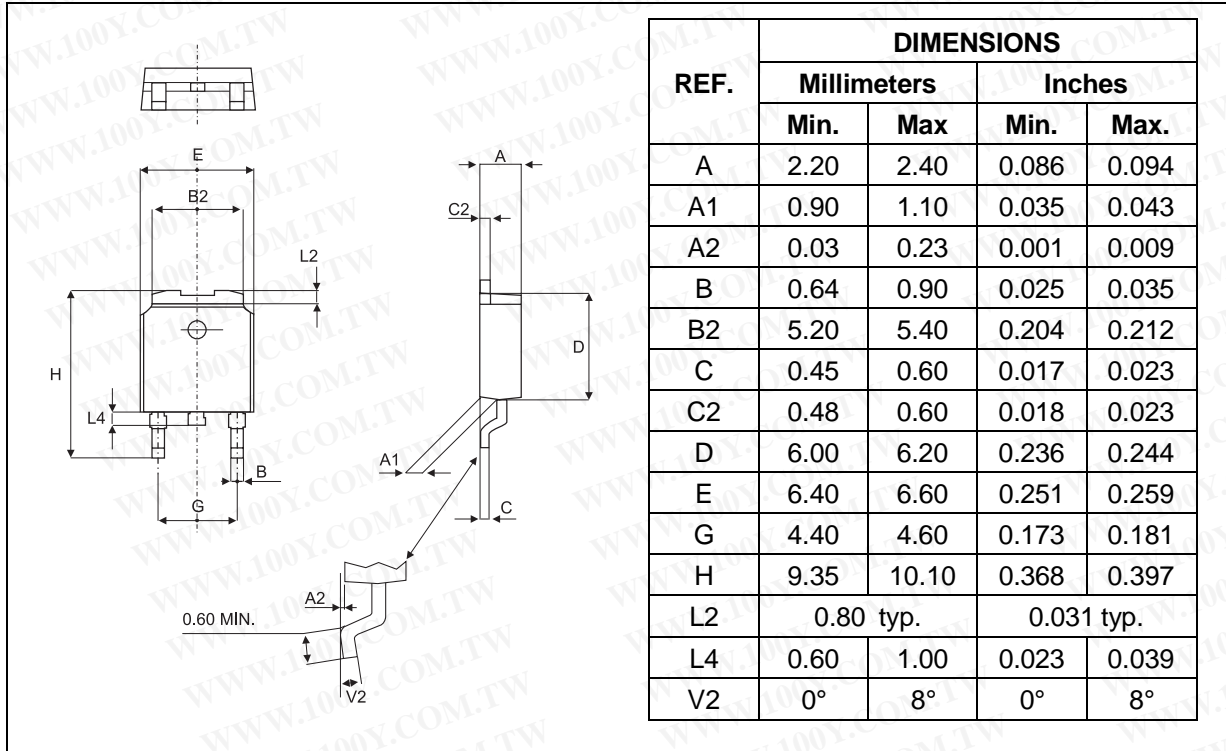

FOOTPRINT DIMENSIONS (in millimeters)

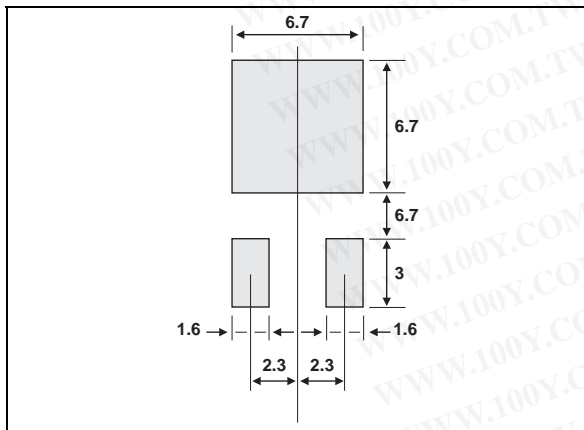

- Cooling method : by conduction (C)

勝特力材料 886-3-5753170
 勝特力电子(上海) 86-21-54151736
 勝特力电子(深圳) 86-755-83298787
[Http://www.100y.com.tw](http://www.100y.com.tw)

PACKAGE MECHANICAL DATA
ISOWATT220AC

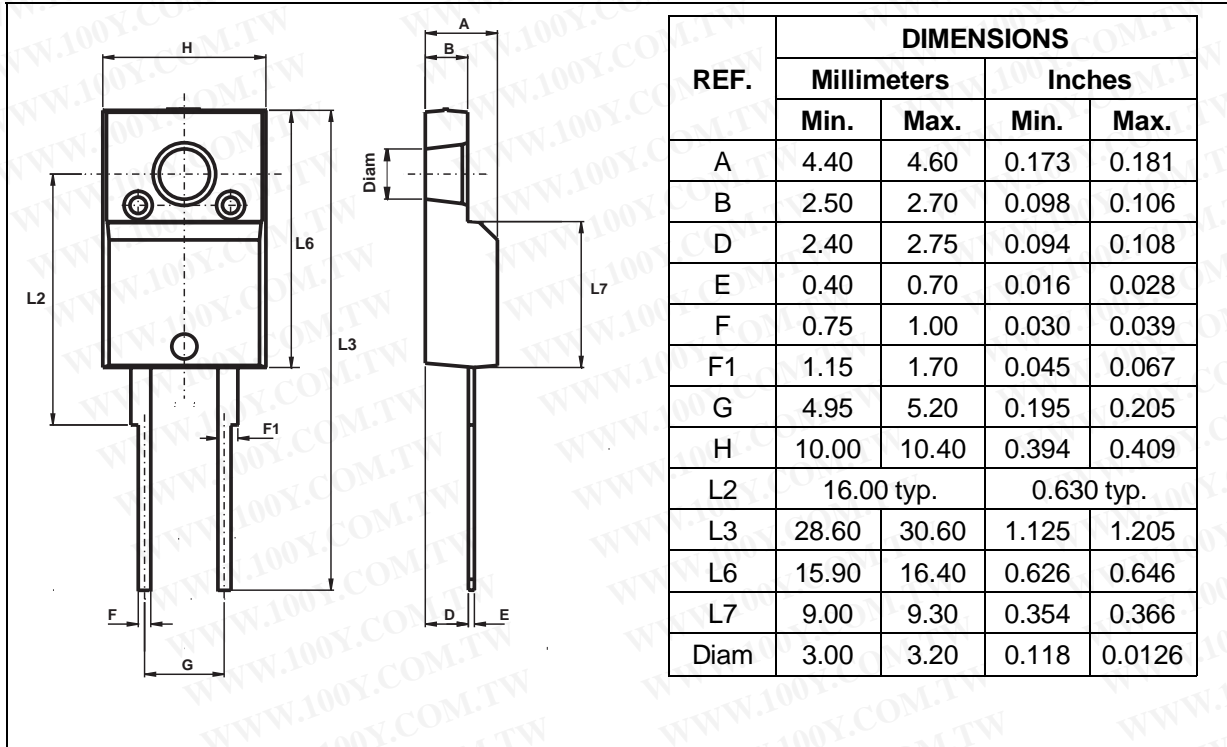

- Cooling method : by conduction (C)
- Recommended torque value : 0.55m.N
- Maximum torque value : 0.7m.N

勝特力材料 886-3-5753170
 勝特力电子(上海) 86-21-54151736
 勝特力电子(深圳) 86-755-83298787
[Http://www.100y.com.tw](http://www.100y.com.tw)

STTA506D/F/B

PACKAGE MECHANICAL DATA
TO-220AC

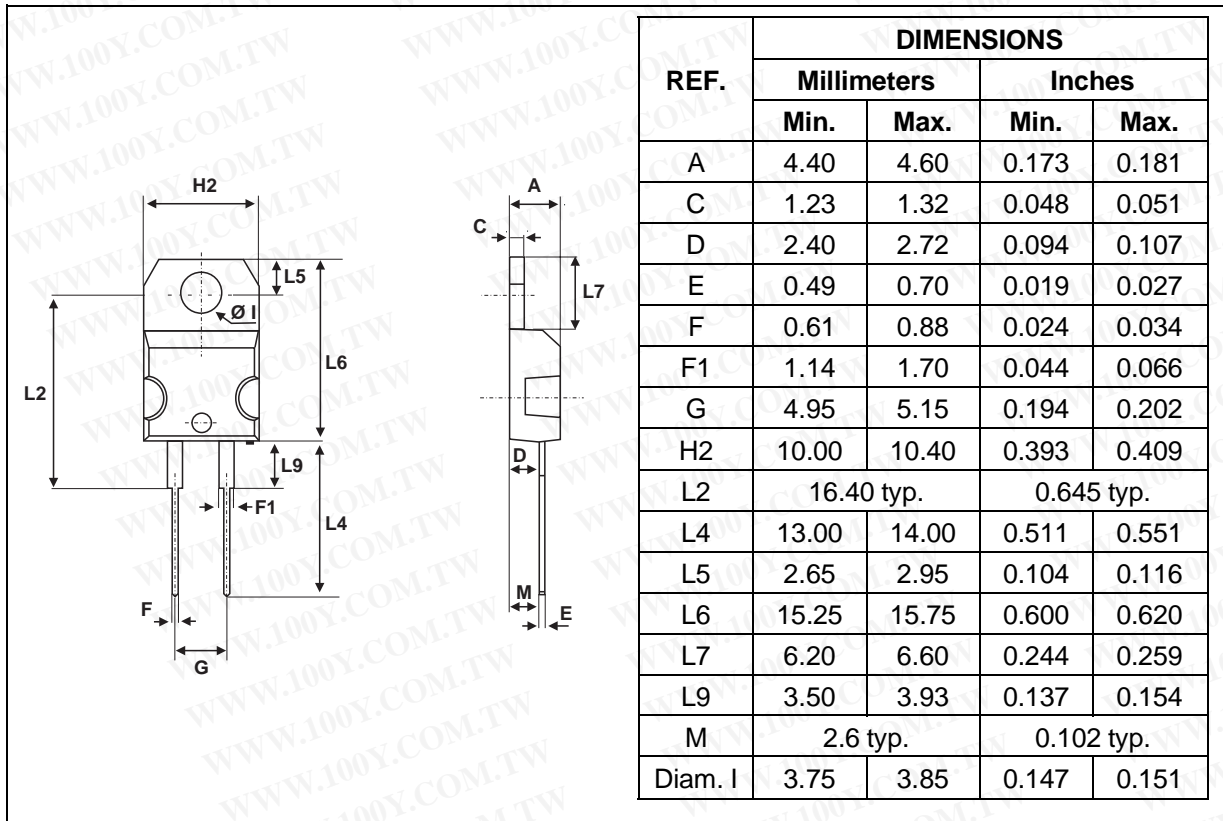

- Cooling method : by conduction (C)
- Recommended torque value : 0.55m.N
- Maximum torque value : 0.7m.N

Ordering type	Marking	Package	Weight	Base qty	Delivery mode
STTA506D	STTA506D	TO-220AC	1.86g	50	Tube
STTA506F	STTA506F	ISOWATT220AC	2g	50	Tube
STTA506B	STTA506B	DPAK	0.3g	75	Tube
STTA506B-TR	STTA506B	DPAK	0.3g	2500	Tape & reel

- Epoxy meets UL94,V0

Information furnished is believed to be accurate and reliable. However, STMicroelectronics assumes no responsibility for the consequences of use of such information nor for any infringement of patents or other rights of third parties which may result from its use. No license is granted by implication or otherwise under any patent or patent rights of STMicroelectronics. Specifications mentioned in this publication are subject to change without notice. This publication supersedes and replaces all information previously supplied. STMicroelectronics products are not authorized for use as critical components in life support devices or systems without express written approval of STMicroelectronics.

The ST logo is a registered trademark of STMicroelectronics
 © 1999 STMicroelectronics - Printed in Italy - All rights reserved.
 STMicroelectronics GROUP OF COMPANIES
 Australia - Brazil - China - Finland - France - Germany - Hong Kong - India - Italy - Japan - Malaysia
 Malta - Morocco - Singapore - Spain - Sweden - Switzerland - United Kingdom - U.S.A.
<http://www.st.com>

