

# 二極氣體放電管

# Gas Tube Arresters

2-Electrode Arresters( $\Phi 8.0 \times 6.0$ )  
 20KA/20A/200A



單位: 毫米

Dimensions:mm

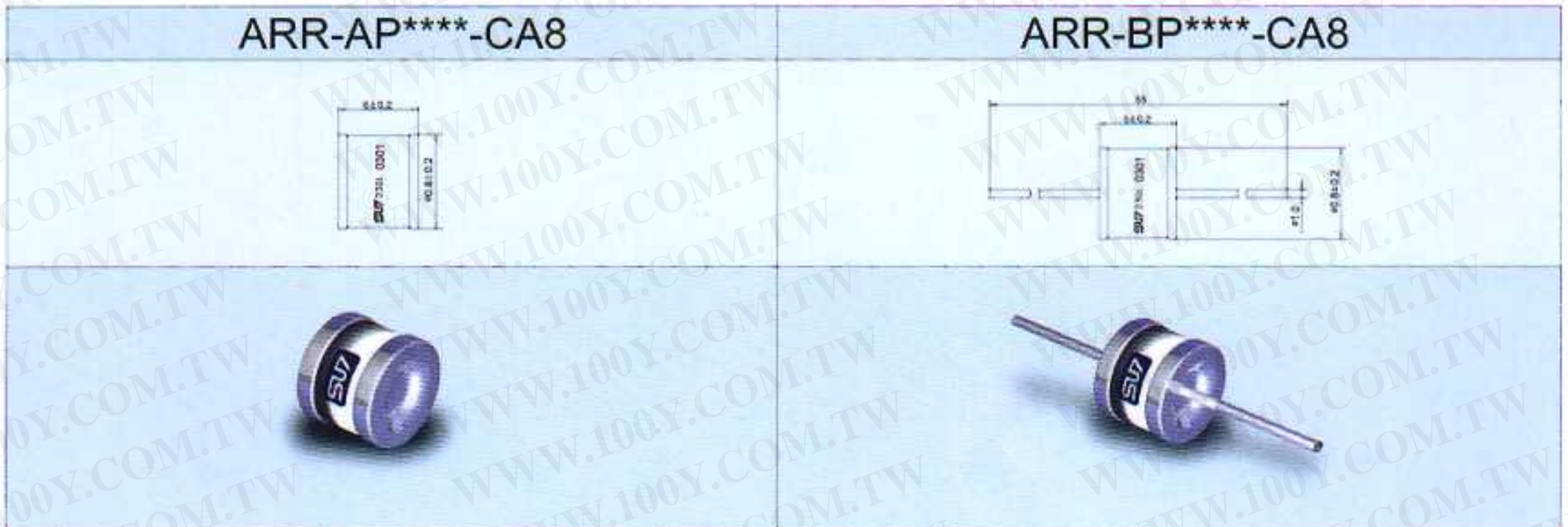

項目 Item	類 型 Parts Number						
不帶引綫 Without lead	ARR-AP075L-CA8	ARR-AP090L-CA8	ARR-AP150L-CA8	ARR-AP230L-CA8	ARR-AP350L-CA8	ARR-AP470L-CA8	ARR-AP600L-CA8
帶引綫 Axial leaded	ARR-BP075L-CA8	ARR-BP090L-CA8	ARR-BP150L-CA8	ARR-BP230L-CA8	ARR-BP350L-CA8	ARR-BP470L-CA8	ARR-BP600L-CA8
直流擊穿電壓(V) DC Breakdown Voltage(@100V/s)	75	90	150	230	350	470	600
電壓範圍 Tolerance of DCBV	±15%	±15%	±15%	±15%	±15%	±15%	±15%
脈衝擊穿電壓(V) Impulse Breakdown Voltage(@1kV/ $\mu$ s)	≤650	≤650	≤650	≤700	≤900	≤1000	≤1200
耐交流電流(A) AC Discharge Current(@50Hz)	20	20	20	20	20	20	20
耐長波電流(A) Surge Discharge Current(@10/1000 $\mu$ s)	200	200	200	200	200	200	200
耐短波電流(kA) Surge Discharge Current(@8/20 $\mu$ s)	20	20	20	20	20	20	20
絕緣電阻(M $\Omega$ ) Insulation Resistance	≥10000	≥10000	≥10000	≥10000	≥10000	≥10000	≥10000
極間電容(pF) Electrode Capacitance(@1MHz)	≤1.5	≤1.5	≤1.5	≤1.5	≤1.5	≤1.5	≤1.5
備注 Note							



# 二極氣體放電管

# Gas Tube Arresters

2-Electrode Arresters( $\Phi 8 \times 6$ )  
 10KA/10A/100A



單位: 毫米

Dimensions:mm

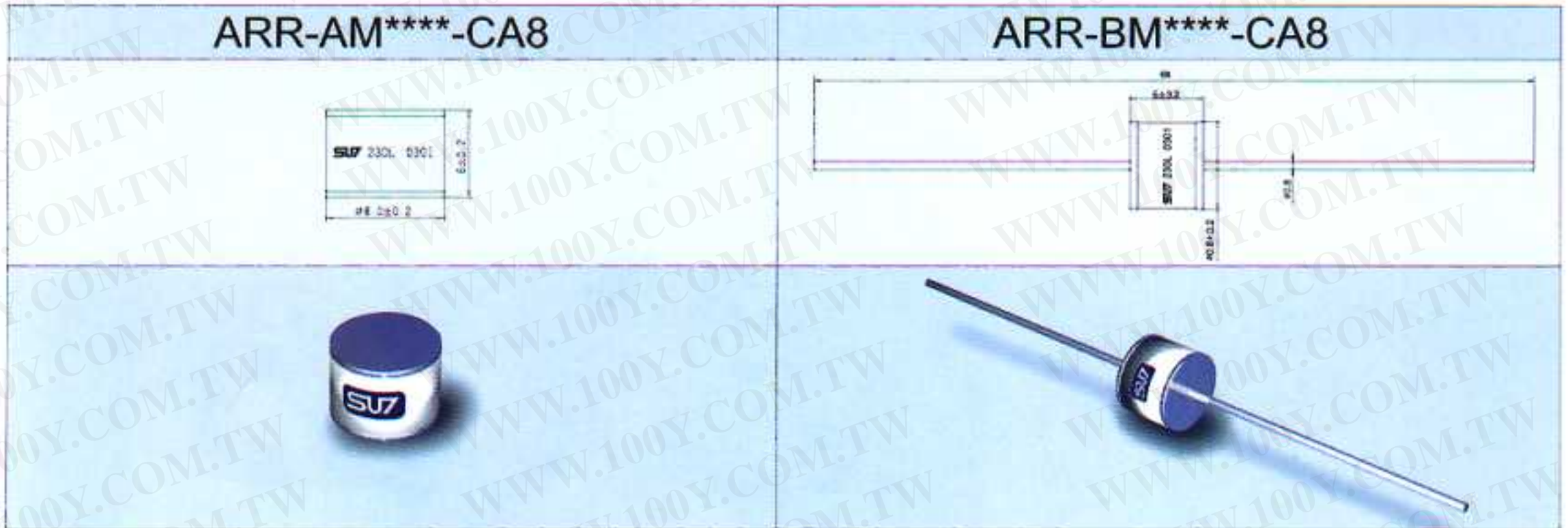

項目 Item	類 型 Parts Number						
不帶引綫 Without lead	ARR-AM075L-CA8	ARR-AM090L-CA8	ARR-AM150L-CA8	ARR-AM230L-CA8	ARR-AM350L-CA8	ARR-AM470L-CA8	ARR-AM600L-CA8
帶引綫 Axial leaded	ARR-BM075L-CA8	ARR-BM090L-CA8	ARR-BM150L-CA8	ARR-BM230L-CA8	ARR-BM350L-CA8	ARR-BM470L-CA8	ARR-BM600L-CA8
直流擊穿電壓 (V) DC Breakdown Voltage(@100V/s)	75	90	150	230	350	470	600
電壓範圍 Tolerance of DCBV	±15%	±15%	±15%	±15%	±15%	±15%	±15%
脈衝擊穿電壓 (V) Impulse Breakdown Voltage(@1kV/μs)	≤650	≤650	≤650	≤700	≤900	≤1000	≤1200
耐交流電流 (A) AC Discharge Current(@50Hz)	10	10	10	10	10	10	10
耐長波電流 (A) Surge Discharge Current(@10/1000μs)	100	100	100	100	100	100	100
耐短波電流 (KA) Surge Discharge Current(@8/20μs)	10	10	10	10	10	10	10
絕緣電阻 (MΩ) Insulation Resistance	≥10000	≥10000	≥10000	≥10000	≥10000	≥10000	≥10000
極間電容 (pF) Electrode Capacitance(@1MHz)	≤1.5	≤1.5	≤1.5	≤1.5	≤1.5	≤1.5	≤1.5
備注 Note							



勝特力材料 886-3-5753170  
 勝特力电子(上海) 86-21-54151736  
 勝特力电子(深圳) 86-755-83298787  
 Http://www.100y.com.tw

# 三極氣體放電管

# Gas Tube Arresters

3-Electrode Arresters( $\Phi 7.5 \times 11.5$ )



單位: 毫米

10KA/10A/100A

Dimensions:mm

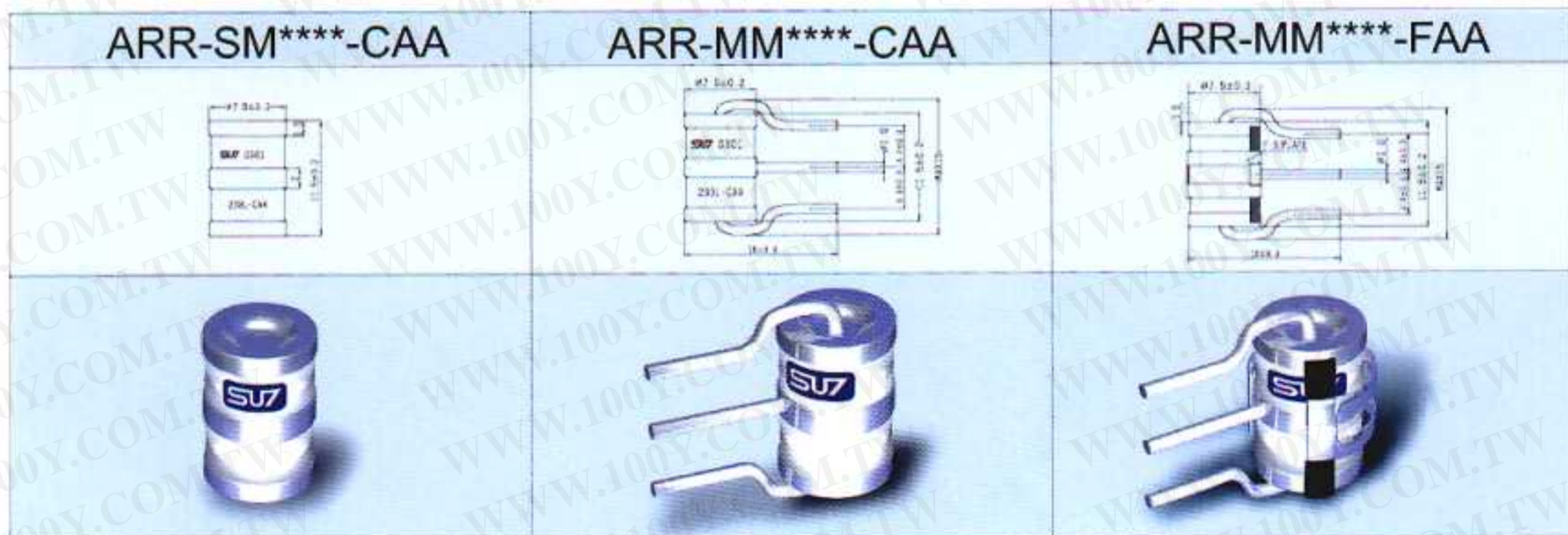

項目 Item	類 型 Parts Number						
不帶引綫 Without lead	ARR-SM075L-CAA	ARR-SM090L-CAA	ARR-SM150L-CAA	ARR-SM230L-CAA	ARR-SM350L-CAA	ARR-SM470L-CAA	ARR-SM600L-CAA
帶引綫 Leaded	ARR-MM075L-CAA	ARR-MM090L-CAA	ARR-MM150L-CAA	ARR-MM230L-CAA	ARR-MM350L-CAA	ARR-MM470L-CAA	ARR-MM600L-CAA
帶引綫及失效保護 Leaded w/ Fail Safe	ARR-MM075L-FAA	ARR-MM090L-FAA	ARR-MM150L-FAA	ARR-MM230L-FAA	ARR-MM350L-FAA	ARR-MM470L-FAA	ARR-MM600L-FAA
直流擊穿電壓 (V) DC Breakdown Voltage(@100V/s)	75	90	150	230	350	470	600
電壓範圍 Tolerance of DCBV	±15%	±15%	±15%	±15%	±15%	±15%	±15%
脈衝擊穿電壓 (V) Impulse Breakdown Voltage(@1kV/μs)	≤650	≤650	≤650	≤700	≤900	≤1000	≤1200
耐交流電流 (A) AC Discharge Current(@50Hz)	10	10	10	10	10	10	10
耐長波電流 (A) Surge Discharge Current(@10/1000 μs)	100	100	100	100	100	100	100
耐短波電流 (kA) Surge Discharge Current(@8/20 μs)	10	10	10	10	10	10	10
絕緣電阻 (MΩ) Insulation Resistance	≥10000	≥10000	≥10000	≥10000	≥10000	≥10000	≥10000
極間電容 (pF) Electrode Capacitance(@1MHz)	≤1.5	≤1.5	≤1.5	≤1.5	≤1.5	≤1.5	≤1.5
備注 Note							



# 三極氣體放電管

# Gas Tube Arresters

3-Electrode Arresters(Φ6X8.5)



單位: 毫米

10KA/10A/100A

Dimensions:mm

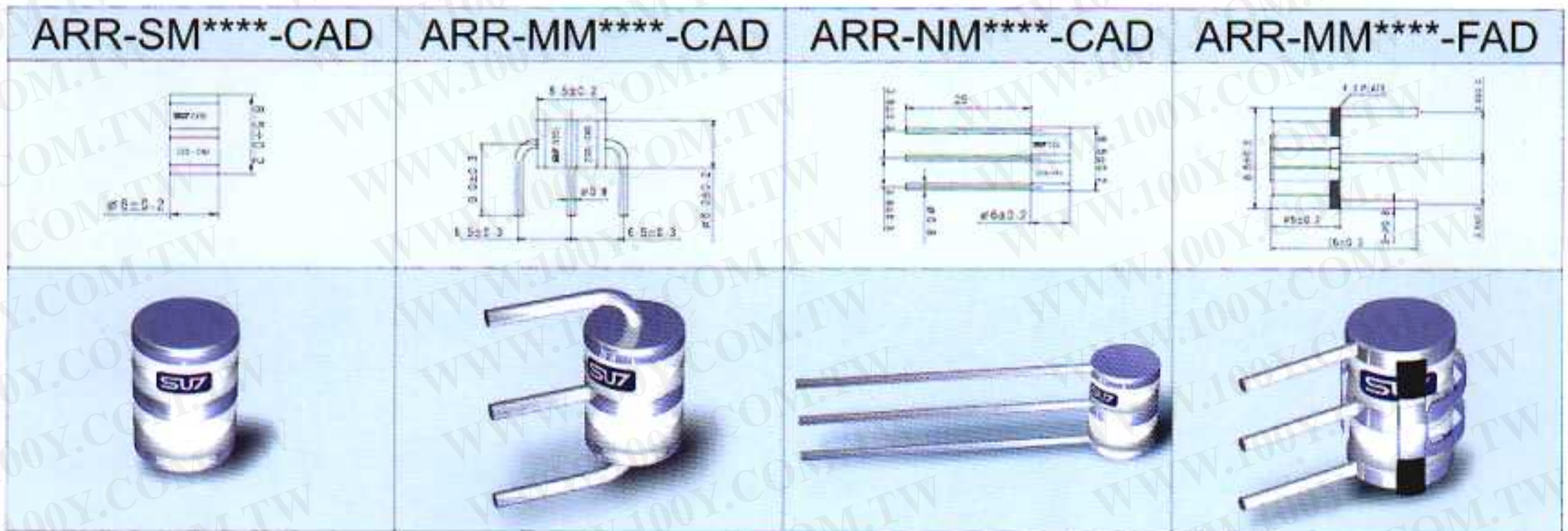

項目 Item	類 型 Parts Number						
不帶引線 Without lead	ARR-SM075L-CAD	ARR-SM090L-CAD	ARR-SM150L-CAD	ARR-SM230L-CAD	ARR-SM350L-CAD	ARR-SM470L-CAD	ARR-SM600L-CAD
帶引線 Leaded	ARR-MM075L-CAD	ARR-MM090L-CAD	ARR-MM150L-CAD	ARR-MM230L-CAD	ARR-MM350L-CAD	ARR-MM470L-CAD	ARR-MM600L-CAD
帶引線 Leaded	ARR-NM075L-CAD	ARR-NM090L-CAD	ARR-NM50L-CAD	ARR-NM230L-CAD	ARR-NM350L-CAD	ARR-NM470L-CAD	ARR-NM600L-CAD
帶引線及失效保護 Leaded w/ Fail Safe	ARR-MM075L-FAD	ARR-MM090L-FAD	ARR-MM150L-FAD	ARR-MM230L-FAD	ARR-MM350L-FAD	ARR-MM470L-FAD	ARR-MM600L-FAD
直流擊穿電壓 (V) DC Breakdown Voltage(@100V/s)	75	90	150	230	350	470	600
電壓範圍 Tolerance of DCBV	±15%	±15%	±15%	±15%	±15%	±15%	±15%
脈衝擊穿電壓 (V) Impulse Breakdown Voltage(@1kV/μs)	≤650	≤650	≤650	≤700	≤900	≤1000	≤1200
耐交流電流 (A) AC Discharge Current(@50Hz)	10	10	10	10	10	10	10
耐長波電流 (A) Surge Discharge Current(@10/1000 μs)	100	100	100	100	100	100	100
耐短波電流 (KA) Surge Discharge Current(@8/20 μs)	10	10	10	10	10	10	10
絕緣電阻 (MΩ) Insulation Resistance	≥10000	≥10000	≥10000	≥10000	≥10000	≥10000	≥10000
極間電容 (pF) Electrode Capacitance(@1MHz)	≤1.5	≤1.5	≤1.5	≤1.5	≤1.5	≤1.5	≤1.5
備注 Note							







# 三極氣體放電管



# Gas Tube Arresters

3-Electrode Arresters(Φ8.5X8.7)  
 5KA/5A/100A



單位: 毫米  
 Dimensions:mm

**ARR-HL\*\*\*\*-CA7**





項目 Item	類 型	Parts Number
不帶引綫 Without lead	ARR-HL230L-CA7	ARR-HL350L-CA7
直流擊穿電壓(V) DC Breakdown Voltage(@100V/s)	230	350
電壓範圍 Tolerance of DCBV	±15%	±15%
脈衝擊穿電壓(V) Impulse Breakdown Voltage(@1kV/μs)	≤700	≤900
耐交流電流(A) AC Discharge Current(@50Hz)	5	5
耐長波電流(A) Surge Discharge Current(@10/1000 μs)	100	100
耐短波電流(kA) Surge Discharge Current(@8/20 μs)	5	5
絕緣電阻(MΩ) Insulation Resistance	≥1000	≥1000
極間電容(pF) Electrode Capacitance(@1MHz)	≤5	≤5
備注 Note		

3-Electrode Arresters(Φ8.5X8.7)  
 10KA/10A/100A



**ARR-KM\*\*\*\*-CAB**

項目 Item	類 型	Parts Number
不帶引綫 Without lead	ARR-KM230L-CAB	ARR-KM350L-CAB
直流擊穿電壓(V) DC Breakdown Voltage(@100V/s)	230	350
電壓範圍 Tolerance of DCBV	±15%	±15%
脈衝擊穿電壓(V) Impulse Breakdown Voltage(@1kV/μs)	≤700	≤900
耐交流電流(A) AC Discharge Current(@50Hz)	10	10
耐長波電流(A) Surge Discharge Current(@10/1000 μs)	100	100
耐短波電流(kA) Surge Discharge Current(@8/20 μs)	10	10
絕緣電阻(MΩ) Insulation Resistance	≥1000	≥1000
極間電容(pF) Electrode Capacitance(@1MHz)	≤5	≤5
備注 Note		