

## References

勝特力材料 886-3-5753170  
 勝特力电子(上海) 86-21-54151736  
 勝特力电子(深圳) 86-755-83298787  
[Http://www.100y.com.tw](http://www.100y.com.tw)

## Control and signalling units Ø 22

Harmony® style 4  
 Pushbuttons, switches and pilot lights with chromium plated metal bezel  
 Separate components and accessories : electrical blocks

814265



ZBE-101

814266



ZBE-102

814267



ZBE-203

814268



ZBE-204

814264



ZB4-BZ009

814262

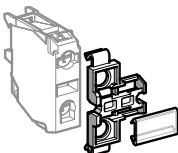

ZBZ-001

814263

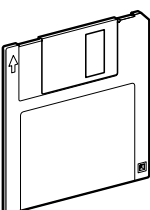

XBY-1U

### Contact blocks with screw clamp terminal connections (1)

Description	Type of contact		Sold in lots of	Unit reference	Weight kg
	N/O	N/C			
<b>Standard single contact blocks</b>	1	–	5	<b>ZBE-101</b>	0.011
	–	1	5	<b>ZBE-102</b>	0.011
<b>Standard double contact blocks</b>	2	–	5	<b>ZBE-203</b>	0.020
	–	2	5	<b>ZBE-204</b>	0.020
	1	1	5	<b>ZBE-205</b>	0.020
<b>Special contact blocks for low power switching with gold flashed contacts</b>	1	–	5	<b>ZBE-1016</b>	0.012
	–	1	5	<b>ZBE-1026</b>	0.012
<b>Special contact blocks for low power switching with gold flashed contacts and dust protection (2)</b>	1	–	5	<b>ZBE-1016P</b>	0.012
	–	1	5	<b>ZBE-1026P</b>	0.012

### Body/fixing collar

For use with	Sold in lots of	Unit reference	Weight kg
<b>Electrical block (contact or light)</b>	10	<b>ZB4-BZ009</b>	0.038

### Clip-on legend holders for electrical blocks with screw clamp terminal connections

<b>Identification of an XB-4B control or signalling unit</b>	10	<b>ZBZ-001</b>	0.001
--	----	----------------	-------

### Sheet of 50 blank legends

<b>Legend holder ZBZ-001</b>	10	<b>ZBY-001</b>	0.023
------------------------------	----	----------------	-------

### SIS labelling software (for legends ZBY-001)

<b>Legend design</b> for English, French, German, Spanish, Italian	1	<b>XBY-1U</b>	0.060
---	---	---------------	-------

(1) The contact blocks enable variable composition of body sub-assemblies and can be stacked to 3 rows, either 3 rows of 3 single contacts or 1 row of 3 double contacts + 1 row of 3 single contacts (double contact blocks occupy 2 rows).  
 (2) It is not possible to fit an additional contact block on the back of these contact blocks.

### Other versions

Contact blocks with Faston connector terminals (6.35 or 2 x 2.8).  
 Please consult your Regional Sales Office.

General : pages 36022/2 to 36024/ 5 Characteristics : pages 36001/2 to 36001/ 5 Dimensions : pages 36020/2 to 36020/ 9

Harmony® style 4

Pushbuttons, switches and pilot lights with chromium plated metal bezel

Separate components and accessories : electrical blocks

勝特力材料 886-3-5753170  
 勝特力电子(上海) 86-21-54151736  
 勝特力电子(深圳) 86-755-83298787  
 Http://www.100y.com.tw

## Light blocks with screw clamp terminal connections

Description	Supply voltage V	Colour of light source	Sold in lots of	Unit reference	Weight kg	
<b>Integral LED</b> (to combine with heads for integral LED) <b>Protected LED</b>	~ 12	White	5	<b>ZBV-BJ1</b>	0.017	
		Green	5	<b>ZBV-BJ3</b>	0.017	
		Red	5	<b>ZBV-BJ4</b>	0.017	
		Yellow	5	<b>ZBV-BJ5</b>	0.017	
		Blue	5	<b>ZBV-BJ6</b>	0.017	
		White	5	<b>ZBV-B1</b>	0.017	
	~ 24	Green	5	<b>ZBV-B3</b>	0.017	
		Red	5	<b>ZBV-B4</b>	0.017	
		Yellow	5	<b>ZBV-B5</b>	0.017	
		Blue	5	<b>ZBV-B6</b>	0.017	
		~ 24...120	White	5	<b>ZBV-BG1</b>	0.017
			Green	5	<b>ZBV-BG3</b>	0.017
Red	5		<b>ZBV-BG4</b>	0.017		
Yellow	5		<b>ZBV-BG5</b>	0.017		
~ 48...120	Blue	5	<b>ZBV-BG6</b>	0.017		
	White	5	<b>ZBV-G1</b>	0.017		
	Green	5	<b>ZBV-G3</b>	0.017		
	Red	5	<b>ZBV-G4</b>	0.017		
~ 230...240	Yellow	5	<b>ZBV-G5</b>	0.017		
	Blue	5	<b>ZBV-G6</b>	0.017		
	White	5	<b>ZBV-M1</b>	0.017		
	Green	5	<b>ZBV-M3</b>	0.017		
<b>Direct supply</b> for BA 9s 2.4 W max. bulb <b>Not included (1)</b>	≤ 250	Red	5	<b>ZBV-M4</b>	0.017	
		Yellow	5	<b>ZBV-M5</b>	0.017	
		Blue	5	<b>ZBV-M6</b>	0.017	
		–	5	<b>ZBV-6</b>	0.016	

814273



ZBV-6

814274



ZBZ-V6

814272



ZB4-BZ009

814269

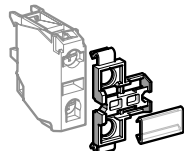

ZBZ-001

814270

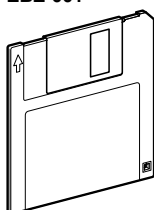

XBY-1U

## LED suppressors

For use with	Supply voltage V	Reference	Weight kg
<b>Light blocks with integral LED fitted with screw clamp terminal connections</b>	~ 120	<b>ZBZ-VG</b>	0.010
	~ 230	<b>ZBZ-VM</b>	0.010

## Body/fixing collar

For use with	Sold in lots of	Unit reference	Weight kg
<b>Electrical blocks</b> (contact or light)	10	<b>ZB4-BZ009</b>	0.038

## Clip-on legend holders for electrical blocks with screw clamp terminal connections

<b>Identification of an XB4-B control or signalling unit</b>	10	<b>ZBZ-001</b>	0.001
<b>Sheet of 50 blank legends</b>			
<b>Legend holder ZBZ-001</b>	10	<b>ZBY-001</b>	0.023

## SIS labelling software (for legends ZBY-001)

<b>Legend design</b> for English, French, German, Spanish, Italian (1) Bulb to be ordered separately: see page 36008/14.	1	<b>XBY-1U</b>	0.060
--	---	---------------	-------

## Other versions

Contact blocks with Faston connector terminals (6.35 or 2 x 2.8).  
Please consult your Regional Sales Office.

勝特力材料 886-3-5753170  
 勝特力电子(上海) 86-21-54151736  
 勝特力电子(深圳) 86-755-83298787  
 Http://www.100y.com.tw

## Control and signalling units Ø 22

Harmony® style 4

Pushbuttons, switches and pilot lights with chromium plated metal bezel

Separate components and accessories : electrical blocks

814278



ZBE-1014

814279



ZBE-1024

814280



ZBV-B04

814282

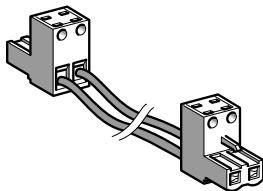

APE-1C2250

814281

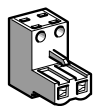

APE-1PAD21

814277



ZB4-BZ009

## Contact blocks for plug-in connector

Description	Type of contact		Sold in lots of	Unit reference	Weight
	N/O	N/C			
<b>Standard contact blocks</b>	1	–	5	<b>ZBE-1014</b>	0.009
	–	1	5	<b>ZBE-1024</b>	0.009

## Light blocks for plug-in connector

Description	Supply voltage V	Colour of light source	Sold in lots of	Unit reference	Weight
<b>Integral LED</b> (to combine with heads for integral LED) <b>Protected LED</b>	~ 24	White	5	<b>ZBV-B14</b>	0.016
		Green	5	<b>ZBV-B34</b>	0.016
		Red	5	<b>ZBV-B44</b>	0.016
		Yellow	5	<b>ZBV-B54</b>	0.016
		Blue	5	<b>ZBV-B64</b>	0.016
		~ 48...120	White	5	<b>ZBV-G14</b>
	Green		5	<b>ZBV-G34</b>	0.016
	Red		5	<b>ZBV-G44</b>	0.016
	Yellow		5	<b>ZBV-G54</b>	0.016
	Blue		5	<b>ZBV-G64</b>	0.016
	~ 230...240		White	5	<b>ZBV-M14</b>
		Green	5	<b>ZBV-M34</b>	0.016
Red		5	<b>ZBV-M44</b>	0.016	
Yellow		5	<b>ZBV-M54</b>	0.016	
Blue		5	<b>ZBV-M64</b>	0.016	

## Connecting cables and connector

Description	Number of connectors	Wire c.s.a. mm <sup>2</sup>	Length mm	Sold in lots of	Unit reference	Weight
<b>Connecting cables with 2-pin connectors 5.08 mm</b>	1	0,75	500	8	<b>APE-1C2150</b>	0,120
	2	0,75	500	8	<b>APE-1C2250</b>	0,180
<b>Self-stripping connector</b>	–	0,75	–	16	<b>APE-1PAD21</b>	0.080

## Body/fixing collar

For use with	Sold in lots of	Unit reference	Weight
<b>Electrical block (contact or light)</b>	10	<b>ZB4-BZ009</b>	0.038



Harmony® style 4

Pushbuttons, switches and pilot lights with chromium plated metal bezel

Separate components and accessories : electrical blocks

勝特力材料 886-3-5753170  
 胜特力电子(上海) 86-21-54151736  
 胜特力电子(深圳) 86-755-83298787  
 Http://www.100y.com.tw

## Contact blocks for printed circuit board connection (1)

Description	Type de contacts		Sold in lots of	Unit reference	Weight kg
					
<b>Standard contact blocks</b>	N/O	N/C			
	1	–	10	<b>ZBE-701</b>	0.002
	–	1	10	<b>ZBE-702</b>	0.002
<b>Special contact blocks for low power switching</b> (with gold flashed contacts and dust protection)	1	–	10	<b>ZBE-7016</b>	0.003
	–	1	10	<b>ZBE-7026</b>	0.003



ZBE-701



ZBE-702

## Light blocks for printed circuit board connection (1)

Description	Supply voltage V	Colour of LED	Sold in lots of	Unit reference	Weight kg
<b>Integral LED</b> (to combine with heads for integral LED)	≈ 24	White	5	<b>ZBV-B17</b>	0.004
		Green	5	<b>ZBV-B37</b>	0.004
		Red	5	<b>ZBV-B47</b>	0.004
		Yellow	5	<b>ZBV-B57</b>	0.004
		Blue	5	<b>ZBV-B67</b>	0.004



ZBV-B07

Protected  
LED

## Adaptor (socket), for printed circuit board connection

For use with	Sold in lots of	Unit reference	Weight kg
<b>Electrical block</b> (contact or light)	10	<b>ZBZ-010</b>	0.008



ZB4-BZ009

## Body/fixing collar

For use with	Sold in lots of	Unit reference	Weight kg
<b>Electrical block</b> (contact or light)	10	<b>ZB4-BZ009</b>	0.038



ZBZ-010

## Accessories specifically for printed circuit board mounting (1)

Description	Application	Sold in lots of	Unit reference	Weight kg
<b>Fixing collar/pillar</b>	Printed circuit board support	10	<b>ZB4-BZ079</b>	0.003
<b>Fixing screw for printed circuit board</b>	Fixing collar/pillar ZB4-BZ079	10	<b>ZBZ-006</b>	0.011



ZB4-BZ079 + ZB4-BZ009

(1) For details of support drilling and printed circuit board: see page 36020/9.  
 Must be used in conjunction with **ZBZ-010** adaptor (socket).

勝特力材料 886-3-5753170  
 勝特力电子(上海) 86-21-54151736  
 勝特力电子(深圳) 86-755-83298787  
[Http://www.100y.com.tw](http://www.100y.com.tw)

## Control and signalling units Ø 22

Harmony® style 4

Pushbuttons, switches and pilot lights with chromium plated metal bezel

Separate components and accessories : for heads



ZBA-●



ZBL-●



ZBA-●33

### Pushbutton caps - unmarked

For use with	Type of push	Colour	Sold in lots of	Unit reference	Weight kg	
<b>ZB4-BA0 circular pushbutton heads supplied without cap</b>	Flush	White	10	<b>ZBA-1</b>	0.001	
		Black	10	<b>ZBA-2</b>	0.001	
		Green	10	<b>ZBA-3</b>	0.001	
		Red	10	<b>ZBA-4</b>	0.001	
		Yellow	10	<b>ZBA-5</b>	0.001	
		Blue	10	<b>ZBA-6</b>	0.001	
		6 colours (1)	1	<b>ZBA-9</b>	0.006	
		Projecting	White	10	<b>ZBL-1</b>	0.001
			Black	10	<b>ZBL-2</b>	0.001
	Green		10	<b>ZBL-3</b>	0.001	
	Red		10	<b>ZBL-4</b>	0.001	
	Yellow		10	<b>ZBL-5</b>	0.001	
	Blue		10	<b>ZBL-6</b>	0.001	
	6 colours (1)		1	<b>ZBL-9</b>	0.006	

### Pushbutton caps - marked (sold in lots of 10)

For use with	Type of push	Marking Text	Colour of cap	Unit reference	Weight kg
<b>ZB4-BA0 circular heads supplied without cap</b>	Flush	I (2)	White	<b>ZBA-331</b>	0.001
			Black	<b>ZBA-131</b>	0.001
		II	White	<b>ZBA-336</b>	0.001
			Black	<b>ZBA-136</b>	0.001
		III	White	<b>ZBA-337</b>	0.001
			Black	<b>ZBA-137</b>	0.001
		IV	White	<b>ZBA-338</b>	0.001
			Black	<b>ZBA-138</b>	0.001
		START (2)	White	<b>ZBA-333</b>	0.001
			Black	<b>ZBA-133</b>	0.001
		ON	White	<b>ZBA-341</b>	0.001
			Black	<b>ZBA-141</b>	0.001
		MARCHE	White	<b>ZBA-342</b>	0.001
			Black	<b>ZBA-142</b>	0.001
		UP (2)	Black	<b>ZBA-343</b>	0.001
		DOWN (2)	White	<b>ZBA-344</b>	0.001
		⊕ (2)	White	<b>ZBA-245</b>	0.001
			Black	<b>ZBA-145</b>	0.001
		↑ (3)	White	<b>ZBA-335</b>	0.001
			Black	<b>ZBA-334</b>	0.001
		O (2)	White	<b>ZBA-432</b>	0.001
			Black	<b>ZBA-232</b>	0.001
		ARRET	White	<b>ZBA-433</b>	0.001
			Black	<b>ZBA-233</b>	0.001
		STOP (2)	White	<b>ZBA-434</b>	0.001
			Black	<b>ZBA-234</b>	0.001
		OFF	White	<b>ZBA-435</b>	0.001
			Black	<b>ZBA-235</b>	0.001
		◇	White	<b>ZBA-346</b>	0.001
		R (2)	White	<b>ZBA-639</b>	0.001
+	White	<b>ZBA-2934</b>	0.001		
-	White	<b>ZBA-2935</b>	0.001		

(1) Set of 6 different coloured caps: White, Black, Green, Red, Yellow, Blue.

(2) Double injection moulded marking

(3) Can be clipped-in at 90° steps through 360°.

## Control and signalling units Ø 22

Harmony® style 4

Pushbuttons, switches and pilot lights with chromium plated metal bezel

Separate components and accessories : for heads

## Standard (30 x 40 mm) legend holders for 8 x 27 mm legends (1)

Description	Legend Colour	Marking	Sold in lots of	Unit reference	Weight kg
<b>Without legend</b>	–	–	10	<b>ZBZ-32</b>	0.001
<b>With blank legend (for engraving)</b>	Black or red background	–	10	<b>ZBY-2101</b>	0.002
	White or yellow background	–	10	<b>ZBY-4101</b>	0.002
<b>With 8 x 27 mm international language marked legend</b>	Black or red background	O (black background)	1	<b>ZBY-2146</b>	0.002
		O (red background)	1	<b>ZBY-2931</b>	0.002
		I	1	<b>ZBY-2147</b>	0.002
		II	1	<b>ZBY-2148</b>	0.002
		O-I	1	<b>ZBY-2178</b>	0.002
		I-II	1	<b>ZBY-2179</b>	0.002
		I-O-II	1	<b>ZBY-2186</b>	0.002
		AUTO	1	<b>ZBY-2115</b>	0.002
		STOP	1	<b>ZBY-2304</b>	0.002
		<b>With 8 x 27 mm French language marked legend</b>	Black or red background (2)	ARRET (red background)	1
ARRET (black background)	1			<b>ZBY-0104</b>	0.002
ARRET GENERAL	1			<b>ZBY-2129</b>	0.002
ARRET REARMEMENT	1			<b>ZBY-2133</b>	0.002
ARRET D'URGENCE	1			<b>ZBY-2130</b>	0.002
ARRET-MARCHE	1			<b>ZBY-2166</b>	0.002
ARRIERE	1			<b>ZBY-2106</b>	0.002
AUTO CYCLE-CYCLE	1			<b>ZBY-2198</b>	0.002
AUTO CYCLE-MAIN	1			<b>ZBY-2199</b>	0.002
AUTO-MAIN	1			<b>ZBY-2164</b>	0.002
AUTO-O-MAIN	1			<b>ZBY-2185</b>	0.002
AVANT	1			<b>ZBY-2105</b>	0.002
AVANT-O-ARRIERE	1			<b>ZBY-2184</b>	0.002
C-P-C-NORMAL	1			<b>ZBY-2165</b>	0.002
CYCLE-MAIN	1			<b>ZBY-2197</b>	0.002
DECLENCHEMENT	1			<b>ZBY-2132</b>	0.002
DEFAUT (black background)	1			<b>ZBY-2134</b>	0.002
DEFAUT (red background)	1			<b>ZBY-2135</b>	0.002
DEPART CYCLE	1			<b>ZBY-2195</b>	0.002
DESCENTE	1			<b>ZBY-2108</b>	0.002
DROITE	1			<b>ZBY-2109</b>	0.002
ENCLENCHEMENT	1			<b>ZBY-2131</b>	0.002
EN SERVICE	1			<b>ZBY-2111</b>	0.002
FERMETURE	1			<b>ZBY-2114</b>	0.002
GAUCHE	1			<b>ZBY-2110</b>	0.002
HORS SERVICE	1			<b>ZBY-2112</b>	0.002
HORS-EN	1			<b>ZBY-2167</b>	0.002
LENT	1			<b>ZBY-2127</b>	0.002
MAIN	1			<b>ZBY-2116</b>	0.002
MARCHE	1			<b>ZBY-2103</b>	0.002
MONTEE	1			<b>ZBY-2107</b>	0.002
OUVERTURE	1			<b>ZBY-2113</b>	0.002
PHASE / PHASE	1	<b>ZBY-2196</b>	0.002		
REARMEMENT (red bk.grnd)	1	<b>ZBY-2123</b>	0.002		
REARMEMENT (black bk.grnd)	1	<b>ZBY-0123</b>	0.002		
SOUS TENSION	1	<b>ZBY-2126</b>	0.002		
VITE	1	<b>ZBY-2128</b>	0.002		

(1) Legends see pages 36008/9 to 36008/11.

(2) "Start" functions: white letters on black background. "Stop" functions: white letters on red background (unless otherwise specified above).

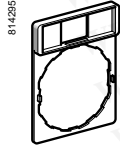

ZBZ-32

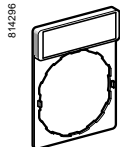

ZBY-101

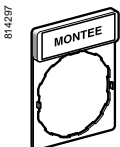

ZBY-2107

勝特力材料 886-3-5753170  
 勝特力电子(上海) 86-21-54151736  
 勝特力电子(深圳) 86-755-83298787  
[Http://www.100y.com.tw](http://www.100y.com.tw)

## Control and signalling units Ø 22

Harmony® style 4

Pushbuttons, switches and pilot lights with chromium plated metal bezel

Separate components and accessories : for heads



ZBY-2303

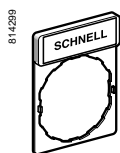

ZBY-2228

## Standard (30 x 40 mm) legend holder for 8 x 27 mm legends (continued)

Description	Legend Colour	Marking	Reference	Weight kg
<b>With English language marked legends</b>	Black or red background (1)	AUTO-HAND	ZBY-2364	0.002
		AUTO-O-HAND	ZBY-2385	0.002
		CLOSE	ZBY-2314	0.002
		DOWN	ZBY-2308	0.002
		EMERGENCY STOP	ZBY-2330	0.002
		FAST	ZBY-2328	0.002
		FORWARD	ZBY-2305	0.002
		HAND	ZBY-2316	0.002
		HAND-OFF-AUTO	ZBY-2387	0.002
		INCH	ZBY-2321	0.002
		LEFT	ZBY-2310	0.002
		OFF	ZBY-2312	0.002
		OFF-ON	ZBY-2367	0.002
		ON	ZBY-2311	0.002
		OPEN	ZBY-2313	0.002
		POWER ON	ZBY-2326	0.002
		RESET (red background)	ZBY-2323	0.002
		RESET (black background)	ZBY-2322	0.002
		REVERSE	ZBY-2306	0.002
		RIGHT	ZBY-2309	0.002
		RUN	ZBY-2334	0.002
		SLOW	ZBY-2327	0.002
		START	ZBY-2303	0.002
		STOP-START	ZBY-2366	0.002
		UP	ZBY-2307	0.002
<b>With German language marked legends</b>	Black or red background (1)	AB	ZBY-2208	0.002
		AUF	ZBY-2207	0.002
		AUS	ZBY-2204	0.002
		AUS-EIN	ZBY-2266	0.002
		AUS-IN BETRIEB	ZBY-2267	0.002
		AUS-RUCKSTELLUNG	ZBY-2233	0.002
		AUSSCHALTEN	ZBY-2232	0.002
		AUTO-HAND	ZBY-2364	0.002
		AUTO-O-HAND	ZBY-2385	0.002
		AUTOZYKL-HAND	ZBY-2299	0.002
		AUTOZYKL- 1 ZYKL	ZBY-2298	0.002
		C-P-C-NORMAL	ZBY-2265	0.002
		EIN	ZBY-2203	0.002
		EINSCHALTEN	ZBY-2231	0.002
		HAND	ZBY-2316	0.002
		LANGSAM	ZBY-2227	0.002
		LINKS	ZBY-2210	0.002
		NOT-AUS (red background)	ZBY-2230	0.002
		NOT-AUS (yellow background)	ZBY-22420001	0.002
		NOT-HALT	ZBY-2229	0.002
		OFFNEN	ZBY-2213	0.002
		RECHTS	ZBY-2209	0.002
		RUCKSTELLUNG	ZBY-2223	0.002
		SCHLIESSEN	ZBY-2214	0.002
		SCHNELL	ZBY-2228	0.002
		SPANNUNG EIN	ZBY-2226	0.002
		STEUERUNG AUS	ZBY-2212	0.002
		STEUERUNG EIN	ZBY-2211	0.002
		STORUNG (black background)	ZBY-2234	0.002
		STORUNG (red background)	ZBY-2235	0.002
		VOR	ZBY-2205	0.002
		VOR-O-ZURUCK	ZBY-2284	0.002
ZURUCK	ZBY-2206	0.002		
ZYKLUS-HAND	ZBY-2297	0.002		
ZYKLUSSTART	ZBY-2295	0.002		

勝特力材料 886-3-5753170  
 勝特力电子(上海) 86-21-54151736  
 勝特力电子(深圳) 86-755-83298787  
[Http://www.100y.com.tw](http://www.100y.com.tw)

(1) "Start" functions: white letters on black background. "Stop" functions: white letters on red background (unless otherwise specified above).

勝特力材料 886-3-5753170  
 勝特力电子(上海) 86-21-54151736  
 勝特力电子(深圳) 86-755-83298787  
 Http://www.100y.com.tw

## Control and signalling units Ø 22

Harmony® style 4

Pushbuttons, switches and pilot lights with chromium plated metal bezel

Separate components and accessories : for heads

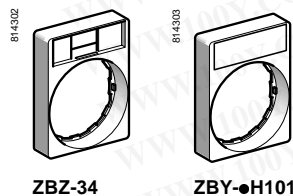

ZBZ-34

ZBY-6H101

## Flush mounting with bezel legend holders (30 x 40 mm) for 8 x 27 mm legends

Description	Colour	Sold in lots of	Unit reference	Weight kg
<b>Without legend</b>	–	10	<b>ZBZ-34</b>	0.003
<b>With blank legend</b>	Black or red background	10	<b>ZBY-2H101</b>	0.004
	White or yellow background	10	<b>ZBY-4H101</b>	0.004

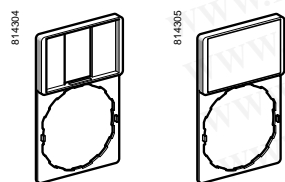

ZBZ-33

ZBY-610

## Standard (30 x 50 mm) legend holders for 18 x 27 mm legends

Description	Colour	Sold in lots of	Unit reference	Weight kg
<b>Without legend</b>	–	10	<b>ZBZ-33</b>	0.001
<b>With blank legend</b>	Black or red background	10	<b>ZBY-6101</b>	0.002
	White or yellow background	10	<b>ZBY-6102</b>	0.002

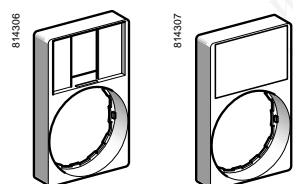

ZBZ-35

ZBY-6H101

## Flush mounting with bezel legend holders (30 x 50 mm) for 18 x 27 mm legends

Description	Colour	Sold in lots of	Unit reference	Weight kg
<b>Without legend</b>	–	10	<b>ZBZ-35</b>	0.003
<b>With blank legend</b>	Black or red background	10	<b>ZBY-6H101</b>	0.004
	White or yellow background	10	<b>ZBY-6H102</b>	0.004

## Legends for engraving

Description	For use with	Colour	Sold in lots of	Unit reference	Weight kg
<b>mm</b>					
<b>8 x 27</b>	30 x 40 mm legend holders	Black or red background	10	<b>ZBY-0101</b>	0.001
		White or yellow background	10	<b>ZBY-0102</b>	0.001
<b>18 x 27</b>	30 x 50 mm legend holders	Black or red background	10	<b>ZBY-5101</b>	0.001
		White or yellow background	10	<b>ZBY-5102</b>	0.001

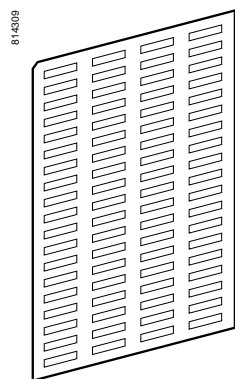

ZBY-4100

## Sheets of peel-off legends (with backing board and protective transparent cover)

Description	For use with	Sold in lots of	Unit reference	Weight kg
<b>Sheet of 76 8 x 27 mm legends</b>	30 x 40 mm legend holders ZBZ-32 and ZBZ-34	10	<b>ZBY-4100</b>	0.043
<b>Sheet of 40 18 x 27 mm legends</b>	30 x 50 mm legend holders ZBZ-33 and ZBZ-35	10	<b>ZBY-5100</b>	0.044

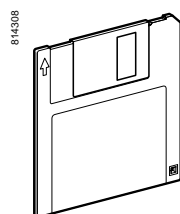

XBY-1U

## SIS labelling software

Application	Reference	Weight kg
<b>Legend design</b> for English, French, German, Spanish, Italian	<b>XBY-1U</b>	0.060



## Control and signalling units Ø 22

Harmony® style 4

Pushbuttons, switches and pilot lights with chromium plated metal bezel

Separate components and accessories : for heads

814310



ZBY-02178

## 8 x 27 mm marked legends (for 30 x 40 mm legend holders ZBZ-32 and ZBZ-34)

Colour	Marking	Reference	Weight kg		
Black or red background (1)	International	O (black background)	ZBY-02146	0.001	
		O (red background)	ZBY-02931	0.001	
		I	ZBY-02147	0.001	
		II	ZBY-02148	0.001	
		O-I	ZBY-02178	0.001	
		I-II	ZBY-02179	0.001	
		I-O-II	ZBY-02186	0.001	
		AUTO	ZBY-02115	0.001	
		STOP	ZBY-02304	0.001	
		French	ARRET (red background)	ZBY-02104	0.001
			ARRET (black background)	ZBY-00104	0.001
			ARRET GENERAL	ZBY-02129	0.001
			ARRET REARMEMENT	ZBY-02133	0.001
ARRET D'URGENCE	ZBY-02130		0.001		
ARRET-MARCHE	ZBY-02166		0.001		
ARRIERE	ZBY-02106		0.001		
AUTO CYCLE-CYCLE	ZBY-02198		0.001		
AUTO CYCLE-MAIN	ZBY-02199		0.001		
AUTO-MAIN	ZBY-02164		0.001		
AUTO-O-MAIN	ZBY-02185		0.001		
AVANT	ZBY-02105		0.001		
AVANT-O-ARRIERE	ZBY-02184		0.001		
C-P-C-NORMAL	ZBY-02165		0.001		
CYCLE-MAIN	ZBY-02197		0.001		
DECLenchement	ZBY-02132		0.001		
DEFAULT (black background)	ZBY-02134		0.001		
DEFAULT (red background)	ZBY-02135		0.001		
DEPART CYCLE	ZBY-02195		0.001		
DESCENTE	ZBY-02108		0.001		
DROITE	ZBY-02109		0.001		
ENCLenchement	ZBY-02131		0.001		
EN SERVICE	ZBY-02111		0.001		
FERMETURE	ZBY-02114		0.001		
GAUCHE	ZBY-02110		0.001		
HORS SERVICE	ZBY-02112		0.001		
HORS-EN	ZBY-02167		0.001		
LENT	ZBY-02127	0.001			
MAIN	ZBY-02116	0.001			
MARCHE	ZBY-02103	0.001			
MONTEE	ZBY-02107	0.001			
OUVERTURE	ZBY-02113	0.001			
PHASE / PHASE	ZBY-02196	0.001			
REARMEMENT (red background)	ZBY-02123	0.001			
REARMEMENT (black background)	ZBY-00123	0.001			
SOUS TENSION	ZBY-02126	0.001			
VITE	ZBY-02128	0.001			

814311



ZBY-00104

(1) "Start" functions: white letters on black background. "Stop" functions: white letters on red background (unless otherwise specified above).

## Control and signalling units Ø 22

Harmony® style 4

Pushbuttons, switches and pilot lights with chromium plated metal bezel

Separate components and accessories : for heads

## 8 x 27 mm legends (for 30 x 40 mm legend holders ZBZ-32 and ZBZ-34) (continued)

Colour	Marking	Reference	Weight kg	
Black or red background (1)	English	AUTO-HAND	ZBY-02364	0.001
		AUTO-O-HAND	ZBY-02385	0.001
		CLOSE	ZBY-02314	0.001
		DOWN	ZBY-02308	0.001
		EMERGENCY STOP	ZBY-02330	0.001
		FAST	ZBY-02328	0.001
		FORWARD	ZBY-02305	0.001
		HAND	ZBY-02316	0.001
		HAND-OFF-AUTO	ZBY-02387	0.001
		INCH	ZBY-02321	0.001
		LEFT	ZBY-02310	0.001
		OFF	ZBY-02312	0.001
		OFF-ON	ZBY-02367	0.001
		ON	ZBY-02311	0.001
		OPEN	ZBY-02313	0.001
		POWER ON	ZBY-02326	0.001
		RESET (red background)	ZBY-02323	0.001
		RESET (black background)	ZBY-02322	0.001
		REVERSE	ZBY-02306	0.001
		RIGHT	ZBY-02309	0.001
		RUN	ZBY-02334	0.001
		SLOW	ZBY-02327	0.001
		START	ZBY-02303	0.001
		STOP-START	ZBY-02366	0.001
		UP	ZBY-02307	0.001
	German	AB	ZBY-02208	0.001
		AUF	ZBY-02207	0.001
		AUS	ZBY-02204	0.001
		AUS-EIN	ZBY-02266	0.001
		AUS-IN BETRIEB	ZBY-02267	0.001
		AUS-RUCKSTELLUNG	ZBY-02233	0.001
		AUSSCHALTEN	ZBY-02232	0.001
		AUTO-HAND	ZBY-02364	0.001
		AUTO-O-HAND	ZBY-02385	0.001
		AUTOZYKL-HAND	ZBY-02299	0.001
		AUTOZYKL- 1 ZYKL	ZBY-02298	0.001
		C-P-C-NORMAL	ZBY-02265	0.001
		EIN	ZBY-02203	0.001
		EINSCHALTEN	ZBY-02231	0.001
		HAND	ZBY-02316	0.001
		LANGSAM	ZBY-02227	0.001
		LINKS	ZBY-02210	0.001
		NOT-AUS (red background)	ZBY-02230	0.001
		NOT-AUS (yellow background)	ZBY-022420001	0.001
		NOT-HALT	ZBY-02229	0.001
		ÖFFNEN	ZBY-02213	0.001
		RECHTS	ZBY-02209	0.001
		RUCKSTELLUNG	ZBY-02223	0.001
		SCHLIESSEN	ZBY-02214	0.001
		SCHNELL	ZBY-02228	0.001
		SPANNUNG EIN	ZBY-02226	0.001
		STEUERUNG AUS	ZBY-02212	0.001
		STEUERUNG EIN	ZBY-02211	0.001
		STORUNG (black background)	ZBY-02234	0.001
		STORUNG (red background)	ZBY-02235	0.001
		VOR	ZBY-02205	0.001
VOR-O-ZURUCK	ZBY-02284	0.001		
ZURUCK	ZBY-02206	0.001		
ZYKLUS-HAND	ZBY-02297	0.001		
ZYKLUSSTART	ZBY-02295	0.001		

(1) "Start" functions: white letters on black background. "Stop" functions: white letters on red background (unless otherwise specified above).

814313

START

ZBY-02303

814314

SCHNELL

ZBY-02228

勝特力材料 886-3-5753170  
 勝特力电子(上海) 86-21-54151736  
 勝特力电子(深圳) 86-755-83298787  
[Http://www.100y.com.tw](http://www.100y.com.tw)

## Control and signalling units Ø 22

Harmony® style 4

Pushbuttons, switches and pilot lights with chromium plated metal bezel

Separate components and accessories : for heads

814316

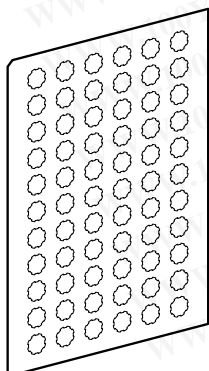

ZBY-1101

814317

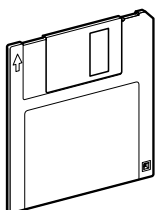

ZBY-1U

814636



ZBY-9330

## Legends for pushbuttons, switches and pilot lights XB4-B

Description	Marking	Sold in lots of	Unit reference	Weight kg	
Sheets of 66 circular peel-off transparent self-adhesive legends	Without	10	ZBY-1101	0.017	
Strips of 66 circular peel-off transparent self-adhesive legends	International	O	10	ZBY-1146	0.017
		I	10	ZBY-1147	0.017
		II	10	ZBY-1148	0.017
		III	10	ZBY-1149	0.017
		STOP	10	ZBY-1304	0.017
		↑	10	ZBY-1912	0.017
	French	ARRET	10	ZBY-1104	0.017
		ARRIERE	10	ZBY-1106	0.017
		AUTO	10	ZBY-1115	0.017
		AVANT	10	ZBY-1105	0.017
		DESCENTE	10	ZBY-1108	0.017
		MAIN	10	ZBY-1116	0.017
		MARCHE	10	ZBY-1103	0.017
MONTEE	10	ZBY-1107	0.017		
English	HAND	10	ZBY-1316	0.017	
	OFF	10	ZBY-1312	0.017	
	ON	10	ZBY-1311	0.017	
	START	10	ZBY-1303	0.017	
German	AB	10	ZBY-1208	0.017	
	AUF	10	ZBY-1207	0.017	
	AUS	10	ZBY-1204	0.017	
	EIN	10	ZBY-1203	0.017	
	ZU	10	ZBY-1214	0.017	

## SIS labelling software

Application	Reference	Weight kg
Legend design for English, French, German, Spanish, Italian	ZBY-1U	0.060

## Circular legends for Emergency Stop mushroom head pushbuttons (yellow)

Diameter mm	Marking on yellow background	Reference	Weight kg
60	Without	ZBY-9101	0.004
	ARRET D'URGENCE	ZBY-9130	0.004
	EMERGENCY STOP	ZBY-9330	0.004
	NOT-AUS	ZBY-9230	0.004
90	Without	ZBY-8101	0.008
	ARRET D'URGENCE	ZBY-8130	0.008
	EMERGENCY STOP	ZBY-8330	0.008
	NOT-AUS	ZBY-8230	0.008

勝特力材料 886-3-5753170  
 勝特力电子(上海) 86-21-54151736  
 勝特力电子(深圳) 86-755-83298787  
[Http://www.100y.com.tw](http://www.100y.com.tw)

## References

勝特力材料 886-3-5753170  
 勝特力电子(上海) 86-21-54151736  
 勝特力电子(深圳) 86-755-83298787  
[Http://www.100y.com.tw](http://www.100y.com.tw)

# Control and signalling units Ø 22

Harmony® style 4

Pushbuttons, switches and pilot lights with chromium plated metal bezel

Separate components and accessories

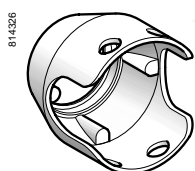
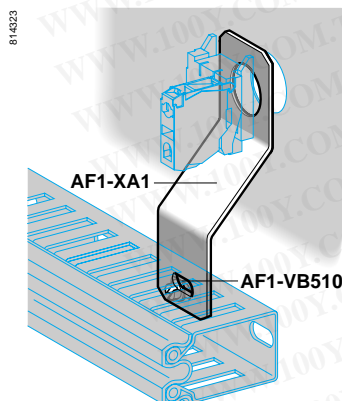

ZBZ-160●

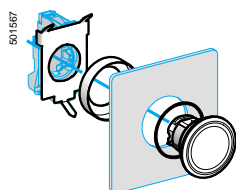

ZB4-BZ011

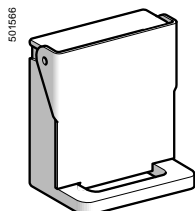

ZB4-BZ64

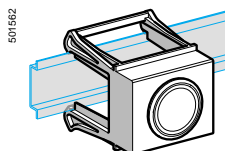

15151

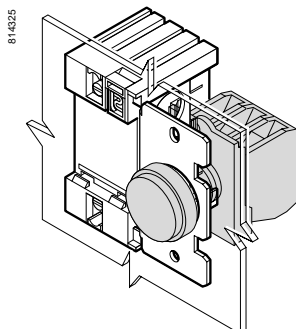

XBZ-S43

## Accessories

Description	Application		Sold in lots of	Unit reference	Weight kg
<b>Cable ducting support</b>	Fixes beneath head		10	<b>AF1-XA1</b>	0.030
<b>M5 x 10 screw, with hexagonal slotted head</b>	For fixing cable ducting		100	<b>AF1-VB510</b>	0.003
<b>Support</b>	Pushbuttons, switches and pilot lights XB4-B		1	<b>DX1-AP52</b>	0,160
<b>Metal guards</b> Padlocking possible	Ø 40 Emergency Stop and mushroom head pushbuttons, either standard or trigger action	Chromium plated	1	<b>ZBZ-1600</b>	0.046
		Black	1	<b>ZBZ-1602</b>	0.046
		Red	1	<b>ZBZ-1604</b>	0.046
		Yellow	1	<b>ZBZ-1605</b>	0.046
		Blue	1	<b>ZBZ-1606</b>	0.046
<b>Plastic guard</b>	For selector switches with standard handle or key switches	Black	1	<b>ZBZ-2102</b>	0.005
<b>Metal blanking plug, round chromium plated (1)</b>	For Ø 22 control and signalling units		10	<b>ZB4-SZ3</b>	0.023
<b>Plastic blanking plug, round, black (2)</b>	For Ø 22 control and signalling units		10	<b>ZB5-SZ3</b>	0.009
<b>Mounting kit</b>	For pushbuttons ZB4-B● with flush mounting with bezel head		1	<b>ZB4-BZ011</b>	0.007
<b>Padlockable flaps</b>	For pushbuttons	Black	1	<b>ZB4-BZ62</b>	0.076
		Red	1	<b>ZB4-BZ64</b>	0.076
		Yellow	1	<b>ZB4-BZ65</b>	0.076
		Blue	1	<b>ZB4-BZ66</b>	0.076
<b>Pushbutton support</b>	35 mm DIN rail, for use in modular enclosure (3)		1	<b>15151</b>	0.040

## AS-i interface module for Ø 22 control and signalling units

Description	Application		Sold in lots of	Unit reference	Weight kg
<b>Panel fixing, in conjunction with a Harmony pushbutton or switch</b>					
<b>Profil S7.F</b>	4 inputs and 4 outputs supplied directly by the bus		1	<b>XBZ-S43</b>	0,100



(1) Requires a **ZB4-BZ009** body/fixing collar for mounting, see page 36008/2.

(2) Supplied complete with fixing nut.

(3) Marketed under the Merlin Gerin brand.

General :  
pages 36022/2 to 36024/

5  
Characteristics :

pages 36001/2 to 36001/  
5

Dimensions :  
pages 36020/2 to 36020/  
9

勝特力材料 886-3-5753170  
 勝特力电子(上海) 86-21-54151736  
 勝特力电子(深圳) 86-755-83298787  
 Http://www.100y.com.tw

## Control and signalling units Ø 22

Harmony® style 4  
 Pushbuttons, switches and pilot lights with chromium plated metal bezel  
 Separate components, accessories and replacement parts



814327

DL1-CJ0●●●



814328

DL1-CE●●●



814329

DL1-CF●●●

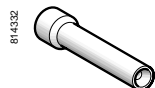

814332

XBF-X13



814330

ZBZ-8



814331

ZBG-455

### BA 9s bulbs and associated accessories

Description	Characteristics	Colour	Sold in lots of	Unit reference	Weight kg
LEDs on BA 9s base	≈ 24 V	White	1	DL1-CJ0241	0.002
		Green	1	DL1-CJ0243	0.002
		Red	1	DL1-CJ0244	0.002
		Yellow	1	DL1-CJ0245	0.002
		Blue	1	DL1-CJ0246	0.002
	≈ 48 V	Green	1	DL1-CJ0483	0.002
		Red	1	DL1-CJ0484	0.002
		Yellow	1	DL1-CJ0485	0.002
6 V - 1,2 W		White	1	DL1-CD0061	0.002
		Green	1	DL1-CD0063	0.002
		Red	1	DL1-CD0064	0.002
		Yellow	1	DL1-CD0065	0.002
Incandescent bulbs	6 V - 1,2 W	–	10	DL1-CB006	0.002
	24 V - 2 W	–	10	DL1-CE024	0.002
	120...130 V - 2,4 W	–	10	DL1-CE130	0.002
Neon bulbs	120...130 V	–	10	DL1-CF110	0.002
	230...240 V	–	10	DL1-CF220	0.002
Bulb extractor	–	–	1	XBF-X13	0.005
Lens cap tightening tool	Illuminated pushbuttons with flush push	–	1	ZBZ-8	0.009

### Replacement keys for Emergency Stop key release heads and key switches

Description	Key number	Reference	Weight kg
Set of 2 keys	455	ZBG-455	0.013
	421E	ZBG-421E	0.014
	458A	ZBG-458A	0.014
	520E	ZBG-520E	0.014
	3131A	ZBG-3131A	0.014

Harmony® style 4

Pushbuttons, switches and pilot lights with chromium plated metal bezel

Replacement parts

勝特力材料 886-3-5753170

胜特力电子(上海) 86-21-54151736

胜特力电子(深圳) 86-755-83298787

Http://www.100y.com.tw



ZBP-0

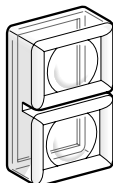

ZBW-008

## Clear boots

Description	For use with pushbuttons	Sold in lots of	Unit reference	Weight kg
<b>Single boots</b>	Flush with circular head	10	ZBP-A	0.002
	Projecting with circular head	10	ZBP-0	0.002
	Flush or projecting with circular head for food industry applications	10	ZBP-0A	0.002
<b>Double boots</b>	Flush or projecting double-headed pushbuttons	10	ZBW-008	0.005
	Flush double-headed pushbuttons	10	ZBW-008F	0.005
	Double-headed pushbuttons for food industry applications	10	ZBW-008A	0.005

## Coloured boots

Description	Colour	Sold in lots of	Unit reference	Weight kg
<b>Coloured boots</b> (can be replaced without removing the head)	Black	10	ZB2-BP012	0.003
	Green	10	ZB2-BP013	0.003
	Red	10	ZB2-BP014	0.003
	Yellow	10	ZB2-BP015	0.003
	Blue	10	ZB2-BP016	0.003

## Lens caps

For use on	Colour	Sold in lots of	Unit reference	Weight kg
<b>Lens caps for light sources with integral LED</b>				
<b>Pilot lights</b>	White	10	ZBV-0113	0.002
	Green	10	ZBV-0133	0.002
	Red	10	ZBV-0143	0.002
	Yellow	10	ZBV-0153	0.002
	Blue	10	ZBV-0163	0.002
	5 different coloured grooved lenses (1)	5	ZBV-0103S	0.010
<b>Illuminated pushbuttons with flush push</b>	White	10	ZBW-9113	0.002
	Green	10	ZBW-9133	0.002
	Red	10	ZBW-9143	0.002
	Yellow	10	ZBW-9153	0.002
	Blue	10	ZBW-9163	0.002
<b>Illuminated pushbuttons with projecting push</b>	White	10	ZBW-9313	0.002
	Green	10	ZBW-9333	0.002
	Red	10	ZBW-9343	0.002
	Yellow	10	ZBW-9353	0.002
	Blue	10	ZBW-9363	0.002

## Lens caps for light sources with BA 9s base fitting

<b>Pilot lights</b>	White	10	ZBV-011	0.002
	Green	10	ZBV-013	0.002
	Red	10	ZBV-014	0.002
	Yellow	10	ZBV-015	0.002
	Blue	10	ZBV-016	0.002
	Clear	10	ZBV-017	0.002
<b>Illuminated pushbuttons with flush push</b>	White	10	ZBW-911	0.002
	Green	10	ZBW-913	0.002
	Red	10	ZBW-914	0.002
	Yellow	10	ZBW-915	0.002
	Blue	10	ZBW-916	0.002
	Clear	10	ZBW-917	0.002
<b>Illuminated pushbuttons with projecting push</b>	White	10	ZBW-931	0.002
	Green	10	ZBW-933	0.002
	Red	10	ZBW-934	0.002
	Yellow	10	ZBW-935	0.002
	Blue	10	ZBW-936	0.002
	Clear	10	ZBW-937	0.002

(1) Clear, Green, Red, Yellow, Blue.



ZBV-01●3



ZBV-01●