

MOSPEC

PLASTIC MEDIUM-POWER COPLEMENTARY SILICON TRANSISTORS

...designed for general-purpose amplifier and low speed switching applications

FEATURES:

- * Collector-Emitter Sustaining Voltage-
 $V_{CE(SUS)}$ = 60 V (Min) - TIP110, TIP115
 = 80 V (Min) - TIP111, TIP116
 = 100 V (Min) - TIP112, TIP117
- * Collector-Emitter Saturation Voltage
 $V_{CE(sat)}$ = 2.5 V (Max.) @ $I_C = 2.0$ A
- * Monolithic Construction with Built-in Base-Emitter Shunt Resistor

NPN	PNP
TIP110	TIP115
TIP111	TIP116
TIP112	TIP117

2.0 AMPERE
 DARLINGTON
 COPLEMENTARY SILICON
 POWER TRANSISTORS
 60-100 VOLTS
 50 WATTS

MAXIMUM RATINGS

Characteristic	Symbol	TIP110 TIP115	TIP111 TIP116	TIP112 TIP117	Unit
Collector-Emitter Voltage	V_{CEO}	60	80	100	V
Collector-Base Voltage	V_{CBO}	60	80	100	V
Emitter-Base Voltage	V_{EBO}	5.0			V
Collector Current-Continuous -Peak	I_C I_{CM}	2.0 4.0			A
Base Current	I_B	50			mA
Total Power Dissipation @ $T_C = 25^\circ\text{C}$ Derate above 25°C	P_D	50 0.4			W W/ $^\circ\text{C}$
Operating and Storage Junction Temperature Range	T_J, T_{STG}	- 65 to +150			$^\circ\text{C}$

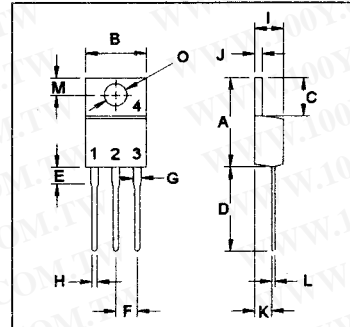
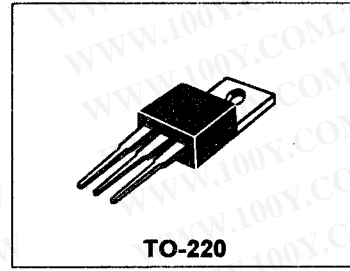

THERMAL CHARACTERISTICS

Characteristic	Symbol	Max	Unit
Thermal Resistance Junction to Case	$R_{\theta jc}$	2.5	$^\circ\text{C}/\text{W}$

DIM	MILLIMETERS	
	MIN	MAX
A	14.68	15.31
B	9.78	10.42
C	5.01	6.52
D	13.06	14.62
E	3.57	4.07
F	2.42	3.66
G	1.12	1.36
H	0.72	0.96
I	4.22	4.98
J	1.14	1.38
K	2.20	2.97
L	0.33	0.55
M	2.48	2.98
O	3.70	3.90

FIGURE -1 POWER DERATING

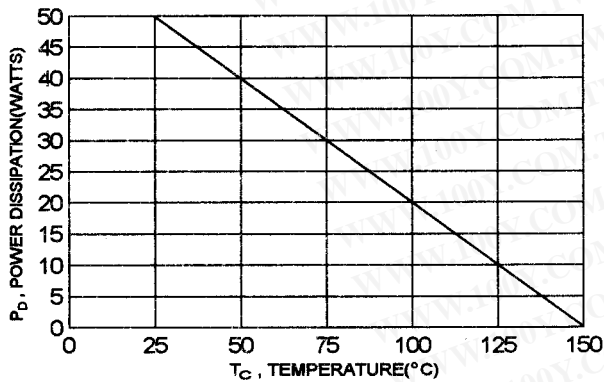

TIP110, TIP111, TIP112 NPN / TIP115, TIP116, TIP117 PNP

ELECTRICAL CHARACTERISTICS ($T_c = 25^\circ\text{C}$ unless otherwise noted)

Characteristic	Symbol	Min	Max	Unit
----------------	--------	-----	-----	------

OFF CHARACTERISTICS

Collector - Emitter Sustaining Voltage (1) ($I_C = 30\text{ mA}, I_B = 0$)	TIP110, TIP115 TIP111, TIP116 TIP112, TIP117	$V_{CE(sus)}$	60 80 100	V
Collector Cutoff Current ($V_{CE} = 30\text{ V}, I_B = 0$) ($V_{CE} = 40\text{ V}, I_B = 0$) ($V_{CE} = 50\text{ V}, I_B = 0$)	TIP110, TIP115 TIP111, TIP116 TIP112, TIP117	I_{CEO}	2.0 2.0 2.0	mA
Collector Cutoff Current ($V_{CB} = 60\text{ V}, I_E = 0$) ($V_{CB} = 80\text{ V}, I_E = 0$) ($V_{CB} = 100\text{ V}, I_E = 0$)	TIP110, TIP115 TIP111, TIP116 TIP112, TIP117	I_{CBO}	1.0 1.0 1.0	mA
Emitter Cutoff Current ($V_{EB} = 5.0\text{ V}, I_C = 0$)		I_{EBO}	2.0	mA

ON CHARACTERISTICS (1)

DC Current Gain ($I_C = 1.0\text{ A}, V_{CE} = 4.0\text{ V}$) ($I_C = 2.0\text{ A}, V_{CE} = 4.0\text{ V}$)		h_{FE}	1000 500	
Collector-Emitter Saturation Voltage ($I_C = 2.0\text{ A}, I_B = 8.0\text{ mA}$)		$V_{CE(sat)}$	2.5	V
Base-Emitter On Voltage ($I_C = 2.0\text{ A}, V_{CE} = 4.0\text{ V}$)		$V_{BE(on)}$	2.8	V

DYNAMIC CHARACTERISTICS

Small-Signal Current Gain ($I_C = 0.75\text{ A}, V_{CE} = 10\text{ V}, f = 1.0\text{ MHz}$)		h_{fe}	25	
Output Capacitance ($V_{CB} = 10\text{ V}, I_E = 0, f = 0.1\text{ MHz}$)	TIP110, TIP111, TIP112 TIP115, TIP116, TIP117	C_{ob}	250 150	pF

(1) Pulse Test: Pulse width = 300 us , Duty Cycle $\leq 2.0\%$

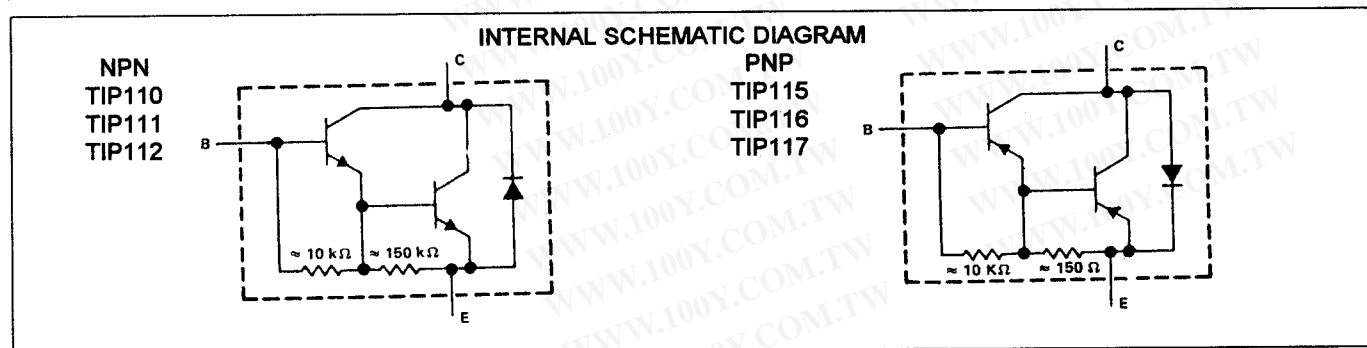

FIG-2 SWITCHING TIME

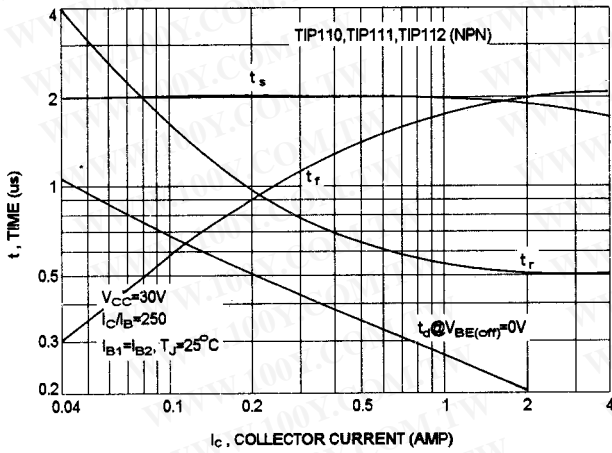

FIG-3 SWITCHING TIME

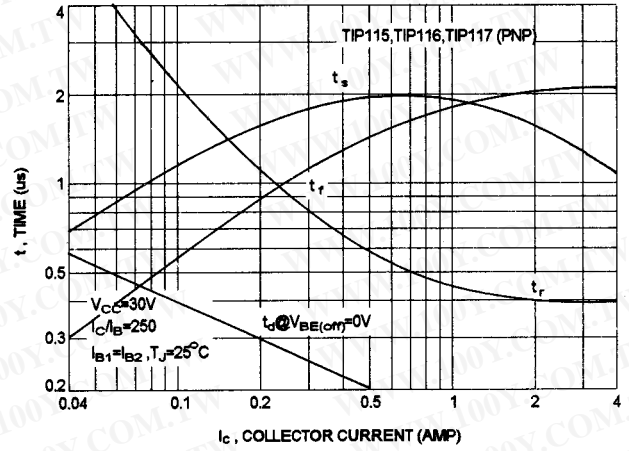

FIG-4 CAPACITANCES

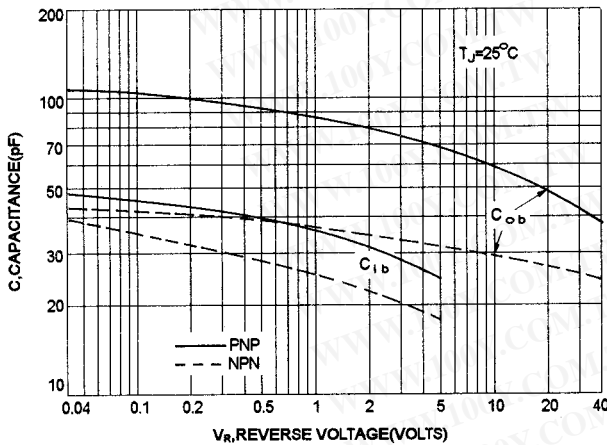

FIG-5 ACTIVE REGION SAFE OPERATING AREA

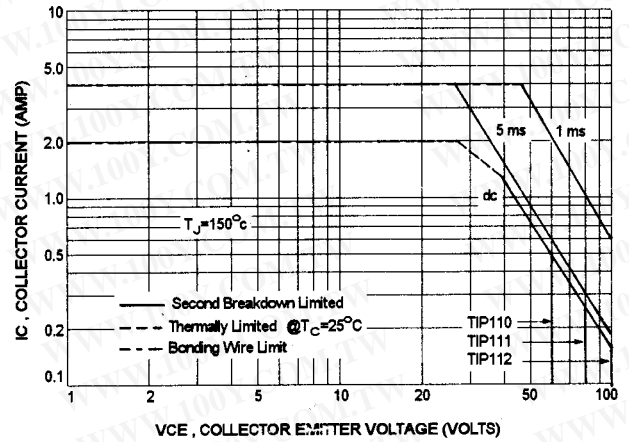
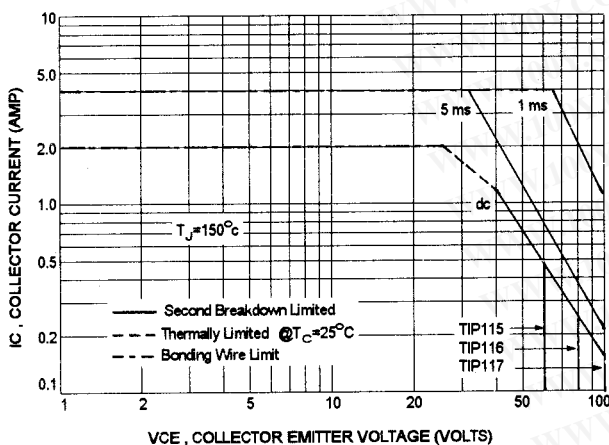

FIG-6 ACTIVE REGION SAFE OPERATING AREA



There are two limitation on the power handling ability of a transistor: average junction temperature and second breakdown safe operating area curves indicate I_C - V_{CE} limits of the transistor that must be observed for reliable operation i.e., the transistor must not be subjected to greater dissipation than curves indicate.

The data of FIG-5 and 6 is base on $T_{J(PK)}=150^\circ C$; T_C is variable depending on power level. second breakdown pulse limits are valid for duty cycles to 10% provided $T_{J(PK)} \leq 150^\circ C$. At high case temperatures, thermal limitation will reduce the power that can be handled to values less than the limitations imposed by second breakdown.