

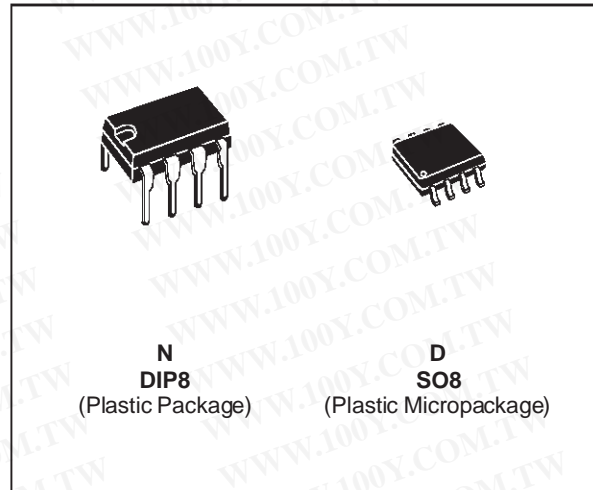

TL071 TL071A - TL071B

LOW NOISE J-FET SINGLE OPERATIONAL AMPLIFIERS

- WIDE COMMON-MODE (UP TO V_{CC}^+) AND DIFFERENTIAL VOLTAGE RANGE
- LOW INPUT BIAS AND OFFSET CURRENT
- LOW NOISE $e_n = 15\text{nV}/\sqrt{\text{Hz}}$ (typ)
- OUTPUT SHORT-CIRCUIT PROTECTION
- HIGH INPUT IMPEDANCE J-FET INPUT STAGE
- LOW HARMONIC DISTORTION : 0.01% (typ)
- INTERNAL FREQUENCY COMPENSATION
- LATCH UP FREE OPERATION
- HIGH SLEW RATE : $16\text{V}/\mu\text{s}$ (typ)



DESCRIPTION

The TL071, TL071A and TL071B are high speed J-FET input single operational amplifiers incorporating well matched, high voltage J-FET and bipolar transistors in a monolithic integrated circuit.

The devices feature high slew rates, low input bias and offset currents, and low offset voltage temperature coefficient.

ORDER CODES

Part Number	Temperature Range	Package	
		N	D
TL071M/AM/BM	-55°C, +125°C	•	•
TL071I/AI/BI	-40°C, +105°C	•	•
TL071C/AC/BC	0°C, +70°C	•	•
Example : TL071CN			

PIN CONNECTIONS (top view)

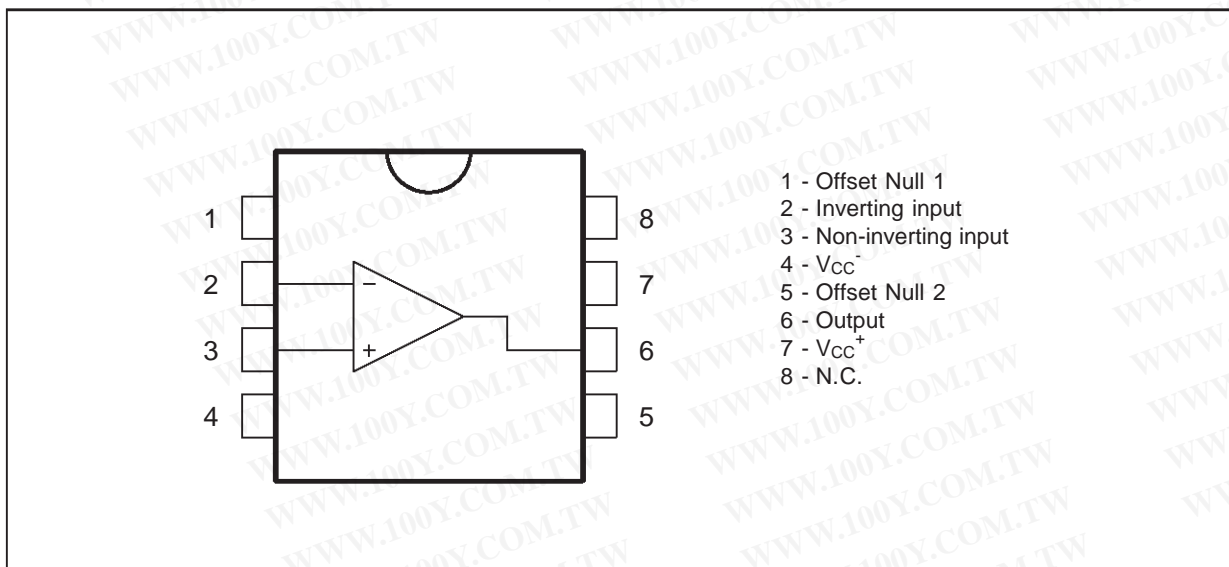

TL071 - TL071A - TL071B

SCHEMATIC DIAGRAM

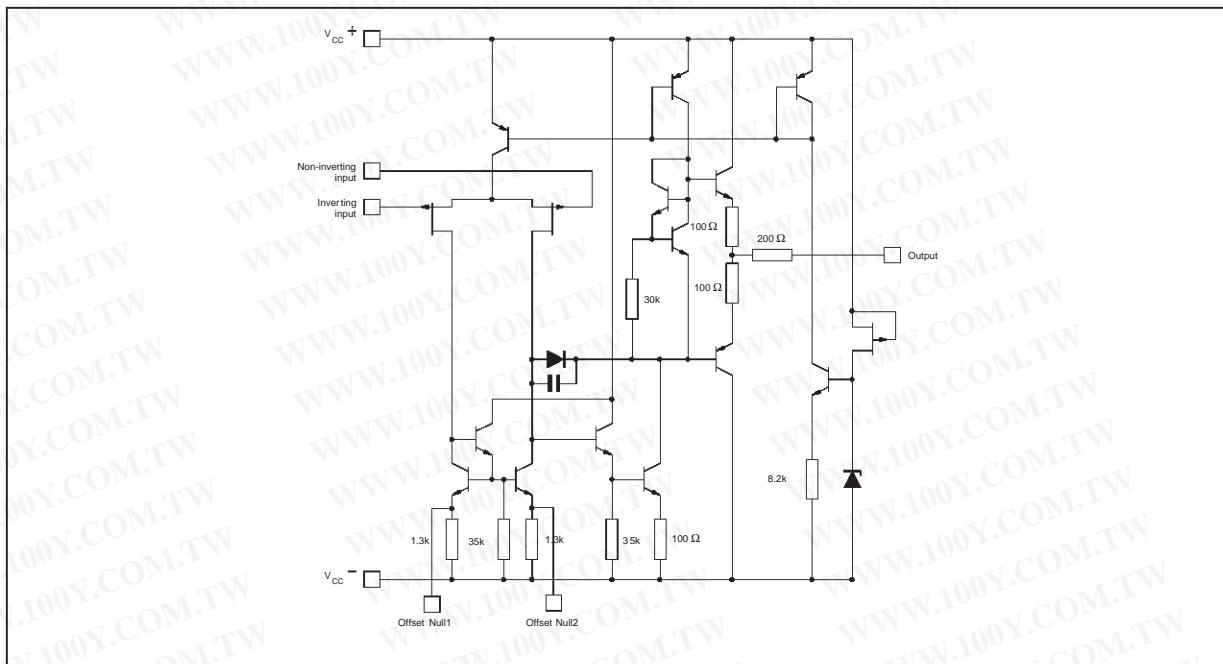

INPUT OFFSET VOLTAGE NULL CIRCUITS

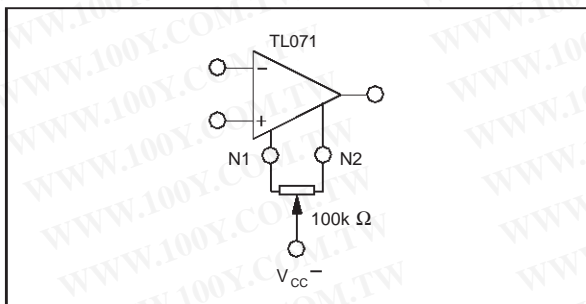

勝特力材料 886-3-5753170
 勝特力电子(上海) 86-21-54151736
 勝特力电子(深圳) 86-755-83298787
[Http://www.100y.com.tw](http://www.100y.com.tw)

ABSOLUTE MAXIMUM RATINGS

Symbol	Parameter	Value	Unit	
V_{CC}	Supply Voltage - (note 1)	± 18	V	
V_i	Input Voltage - (note 3)	± 15	V	
V_{id}	Differential Input Voltage - (note 2)	± 30	V	
P_{tot}	Power Dissipation	680	mW	
	Output Short-circuit Duration - (note 4)	Infinite		
T_{oper}	Operating Free Air Temperature Range	TL071C,AC,BC TL071I,AI,BI TL071M,AM,BM	0 to 70 -40 to 105 -55 to 125	$^{\circ}C$
T_{stg}	Storage Temperature Range		-65 to 150	$^{\circ}C$

- Notes :
1. All voltage values, except differential voltage, are with respect to the zero reference level (ground) of the supply voltages where the zero reference level is the midpoint between V_{CC}^{+} and V_{CC}^{-} .
 2. Differential voltages are at the non-inverting input terminal with respect to the inverting input terminal.
 3. The magnitude of the input voltage must never exceed the magnitude of the supply voltage or 15 volts, whichever is less.
 4. The output may be shorted to ground or to either supply. Temperature and/or supply voltages must be limited to ensure that the dissipation rating is not exceeded.

ELECTRICAL CHARACTERISTICS

V_{CC} = ±15V, T_{amb} = 25°C (unless otherwise specified)

Symbol	Parameter	TL071I,M,AC,AI, AM,BC,BI,BM			TL071C			Unit
		Min.	Typ.	Max.	Min.	Typ.	Max.	
V _{io}	Input Offset Voltage (R _S = 50Ω) T _{amb} = 25°C T _{min.} ≤ T _{amb} ≤ T _{max.}		3 3 1	10 6 3 13 7 5		3 10		mV
DV _{io}	Input Offset Voltage Drift		10			10		μV/°C
I _{io}	Input Offset Current * T _{amb} = 25°C T _{min.} ≤ T _{amb} ≤ T _{max.}		5	100 4		5 100		pA nA
I _{ib}	Input Bias Current * T _{amb} = 25°C T _{min.} ≤ T _{amb} ≤ T _{max.}		20	200 20		20 200		pA nA
A _{vd}	Large Signal Voltage Gain (R _L = 2kΩ, V _O = ±10V) T _{amb} = 25°C T _{min.} ≤ T _{amb} ≤ T _{max.}	50 25	200		25 15	200		V/mV
SVR	Supply Voltage Rejection Ratio (R _S = 50Ω) T _{amb} = 25°C T _{min.} ≤ T _{amb} ≤ T _{max.}	80 80	86		70 70	86		dB
I _{CC}	Supply Current, no Load T _{amb} = 25°C T _{min.} ≤ T _{amb} ≤ T _{max.}		1.4	2.5 2.5		1.4 2.5		mA
V _{icm}	Input Common Mode Voltage Range	±11	+15 -12		±11	+15 -12		V
CMR	Common Mode Rejection Ratio (R _S = 50Ω) T _{amb} = 25°C T _{min.} ≤ T _{amb} ≤ T _{max.}	80 80	86		70 70	86		dB
I _{os}	Output Short-circuit Current T _{amb} = 25°C T _{min.} ≤ T _{amb} ≤ T _{max.}	10 10	40	60 60	10 10	40 60		mA
±V _{OPP}	Output Voltage Swing T _{amb} = 25°C T _{min.} ≤ T _{amb} ≤ T _{max.}		10 12 10 12	12 13.5 2kΩ 10kΩ		10 12 10 12		V
SR	Slew Rate (V _{in} = 10V, R _L = 2kΩ, C _L = 100pF, T _{amb} = 25°C, unity gain)		8	16		8	16	V/μs
t _r	Rise Time (V _{in} = 20mV, R _L = 2kΩ, C _L = 100pF, T _{amb} = 25°C, unity gain)			0.1		0.1		μs
K _{OV}	Overshoot (V _{in} = 20mV, R _L = 2kΩ, C _L = 100pF, T _{amb} = 25°C, unity gain)			10		10		%
GBP	Gain Bandwidth Product (f = 100kHz, T _{amb} = 25°C, V _{in} = 10mV, R _L = 2kΩ, C _L = 100pF)	2.5	4		2.5	4		MHz
R _i	Input Resistance			10 ¹²		10 ¹²		Ω
THD	Total Harmonic Distortion (f = 1kHz, A _V = 20dB, R _L = 2kΩ, C _L = 100pF, T _{amb} = 25°C, V _O = 2V _{PP})			0.01		0.01		%
e _n	Equivalent Input Noise Voltage (f = 1kHz, R _S = 100Ω)			15		15		$\frac{nV}{\sqrt{Hz}}$
∅ _m	Phase Margin			45		45		Degrees

* The input bias currents are junction leakage currents which approximately double for every 10°C increase in the junction temperature.



勝特力材料 886-3-5753170
 勝特力电子(上海) 86-21-54151736
 勝特力电子(深圳) 86-755-83298787
[Http://www.100y.com.tw](http://www.100y.com.tw)

MAXIMUM PEAK-TO-PEAK OUTPUT VOLTAGE VERSUS FREQUENCY

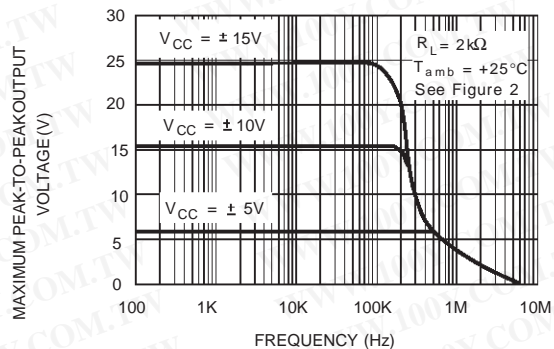

MAXIMUM PEAK-TO-PEAK OUTPUT VOLTAGE VERSUS FREQUENCY

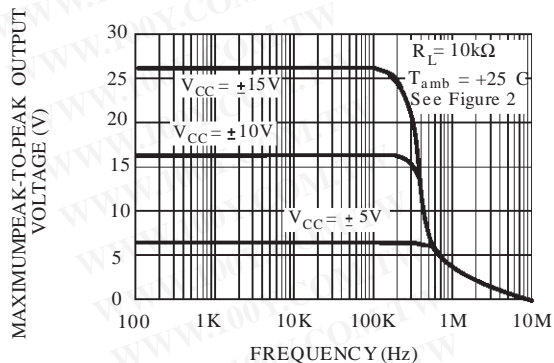

MAXIMUM PEAK-TO-PEAK OUTPUT VOLTAGE VERSUS FREQUENCY

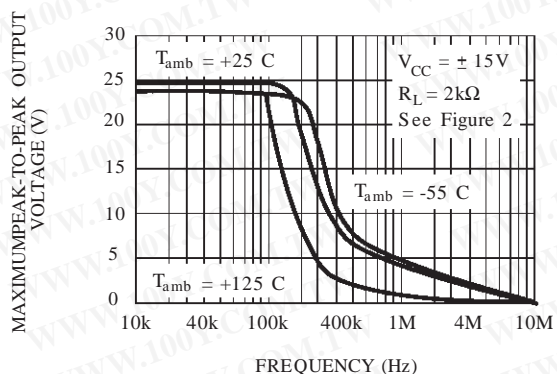

MAXIMUM PEAK-TO-PEAK OUTPUT VOLTAGE VERSUS FREE AIR TEMP.

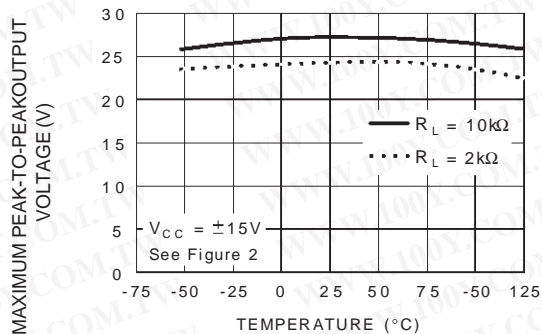

MAXIMUM PEAK-TO-PEAK OUTPUT VOLTAGE VERSUS LOAD RESISTANCE

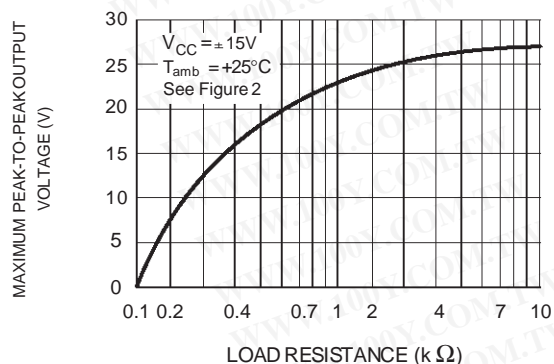

MAXIMUM PEAK-TO-PEAK OUTPUT VOLTAGE VERSUS SUPPLY VOLTAGE

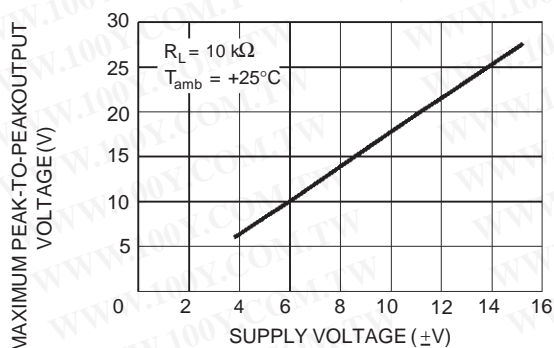

INPUT BIAS CURRENT VERSUS FREE AIR TEMPERATURE

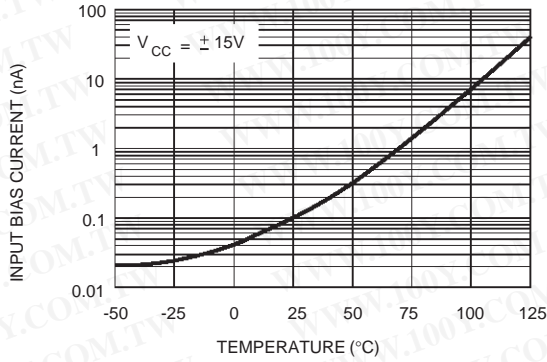

LARGE SIGNAL DIFFERENTIAL VOLTAGE AMPLIFICATION VERSUS FREE AIR TEMPERATURE

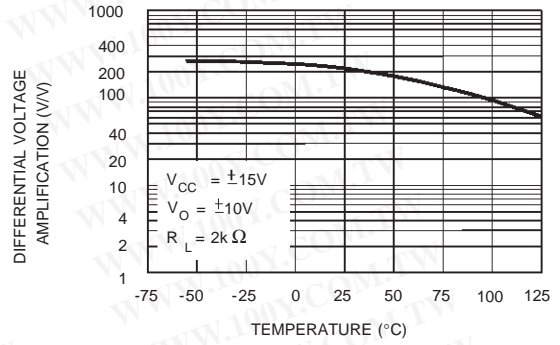

LARGE SIGNAL DIFFERENTIAL VOLTAGE AMPLIFICATION AND PHASE SHIFT VERSUS FREQUENCY

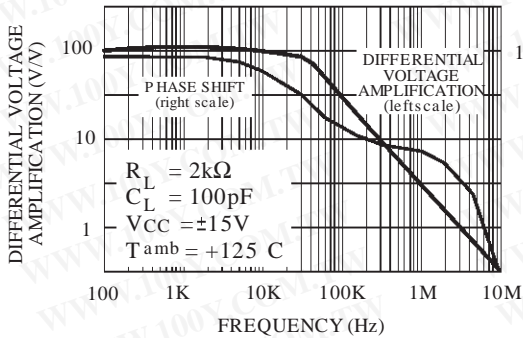

TOTAL POWER DISSIPATION VERSUS FREE AIR TEMPERATURE

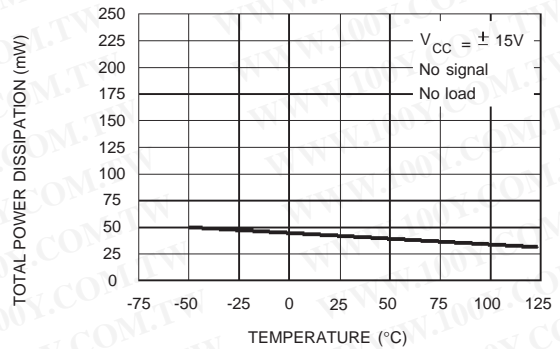

SUPPLY CURRENT PER AMPLIFIER VERSUS FREE AIR TEMPERATURE

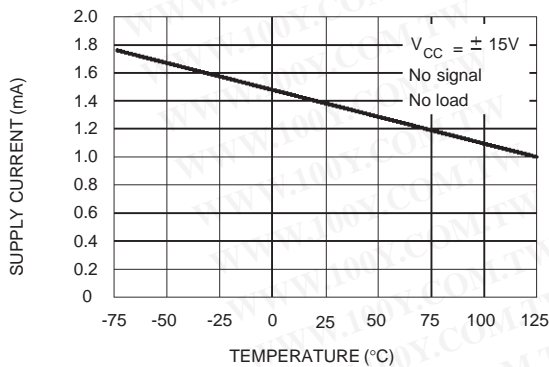

COMMON MODE REJECTION RATIO VERSUS FREE AIR TEMPERATURE

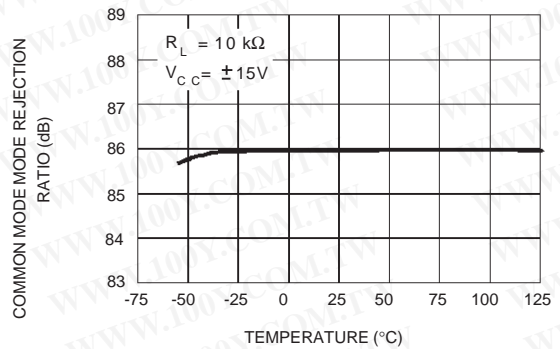

勝特力材料 886-3-5753170
 勝特力电子(上海) 86-21-54151736
 勝特力电子(深圳) 86-755-83298787
[Http://www.100y.com.tw](http://www.100y.com.tw)

VOLTAGE FOLLOWER LARGE SIGNAL PULSE RESPONSE

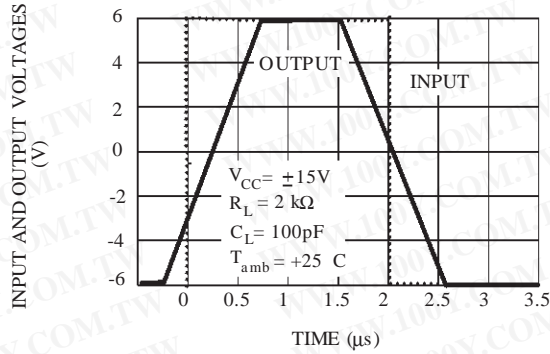

OUTPUT VOLTAGE VERSUS ELAPSED TIME

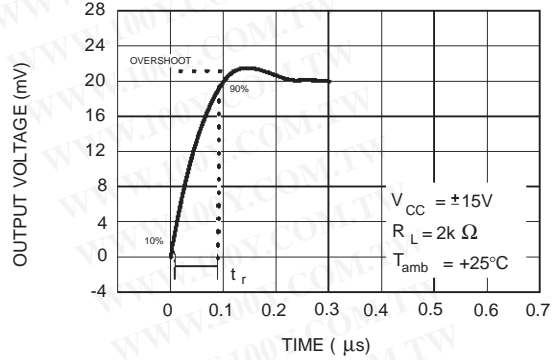

EQUIVALENT INPUT NOISE VOLTAGE VERSUS FREQUENCY

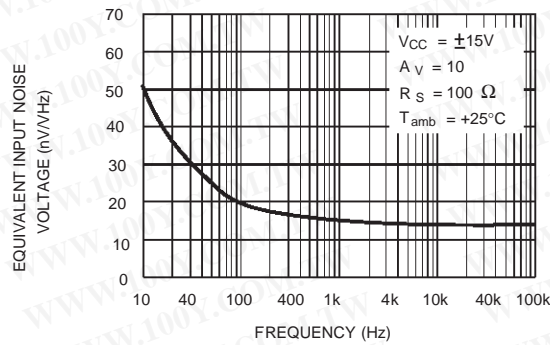

TOTAL HARMONIC DISTORTION VERSUS FREQUENCY

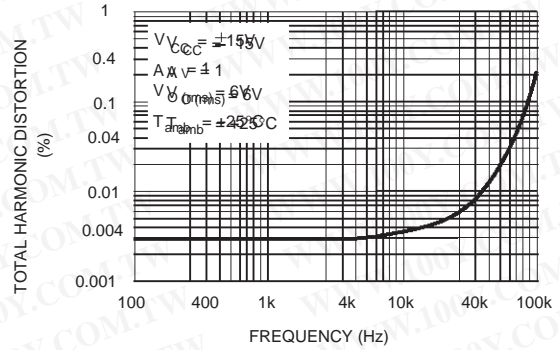

勝特力材料 886-3-5753170
 勝特力电子(上海) 86-21-54151736
 勝特力电子(深圳) 86-755-83298787
[Http://www.100y.com.tw](http://www.100y.com.tw)

PARAMETER MEASUREMENT INFORMATION

Figure 1 : Voltage Follower

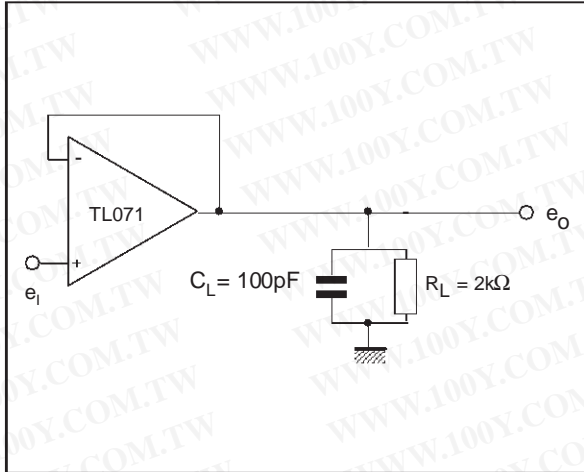
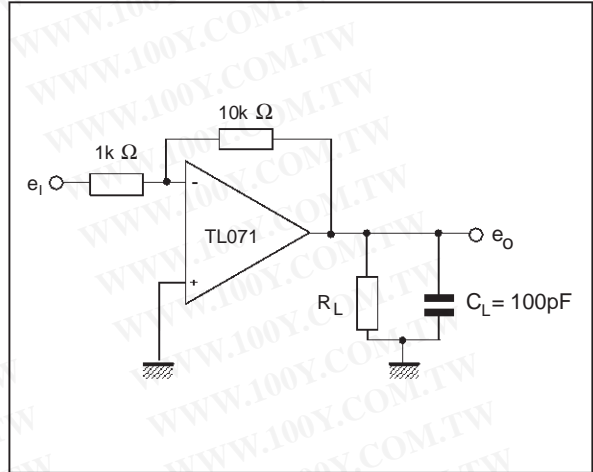
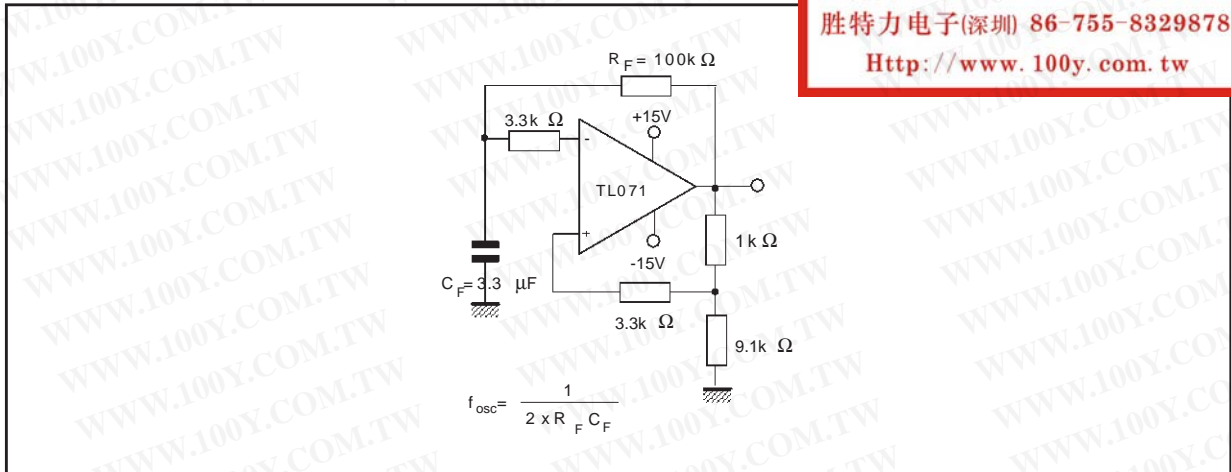

Figure 2 : Gain-of-10 Inverting Amplifier



TYPICAL APPLICATIONS

(0.5Hz) SQUARE WAVE OSCILLATOR



勝特力材料 886-3-5753170
 勝特力电子(上海) 86-21-54151736
 勝特力电子(深圳) 86-755-83298787
[Http://www.100y.com.tw](http://www.100y.com.tw)

HIGH Q NOTCH FILTER

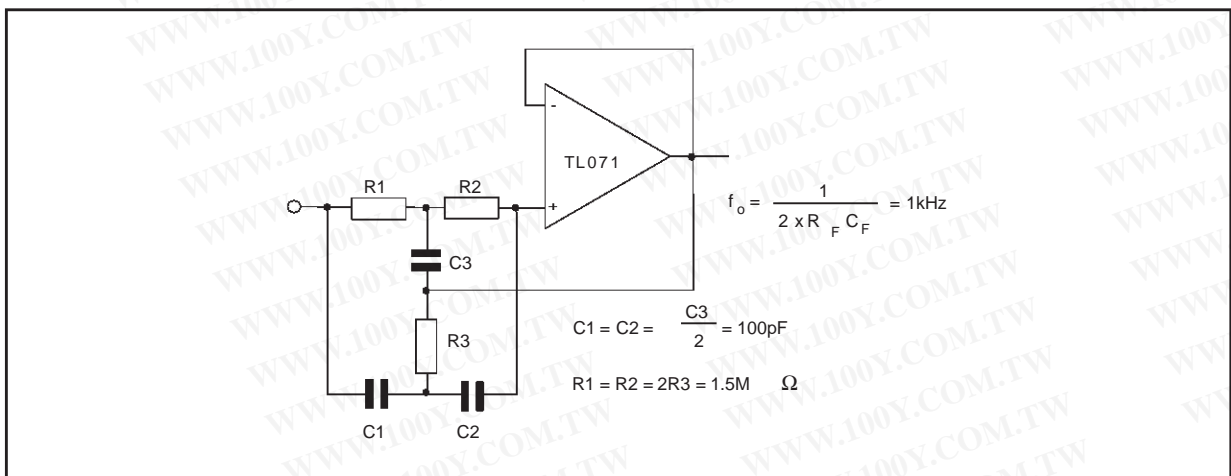

TL071 - TL071A - TL071B

PACKAGE MECHANICAL DATA 8 PINS - PLASTIC DIP

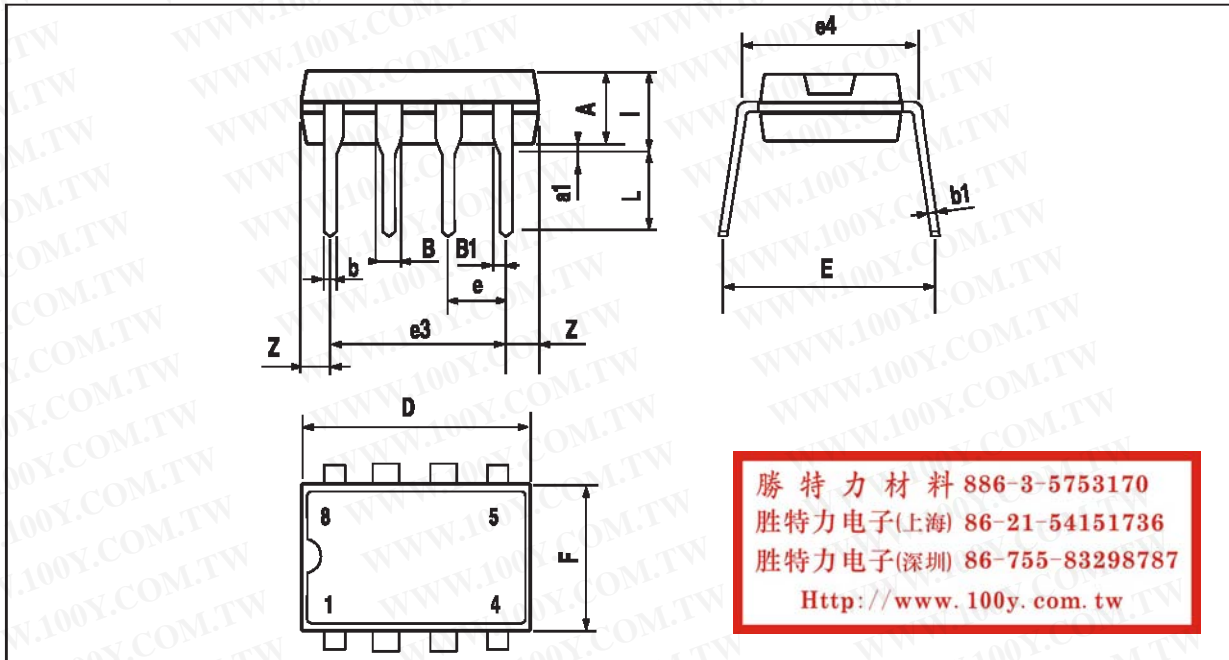

勝特力材料 886-3-5753170
 勝特力电子(上海) 86-21-54151736
 勝特力电子(深圳) 86-755-83298787
[Http://www.100y.com.tw](http://www.100y.com.tw)

Dimensions	Millimeters			Inches		
	Min.	Typ.	Max.	Min.	Typ.	Max.
A		3.32			0.131	
a1	0.51			0.020		
B	1.15		1.65	0.045		0.065
b	0.356		0.55	0.014		0.022
b1	0.204		0.304	0.008		0.012
D			10.92			0.430
E	7.95		9.75	0.313		0.384
e		2.54			0.100	
e3		7.62			0.300	
e4		7.62			0.300	
F			6.6			0.260
i			5.08			0.200
L	3.18		3.81	0.125		0.150
Z			1.52			0.060

PACKAGE MECHANICAL DATA
8 PINS - PLASTIC MICROPACKAGE (SO)

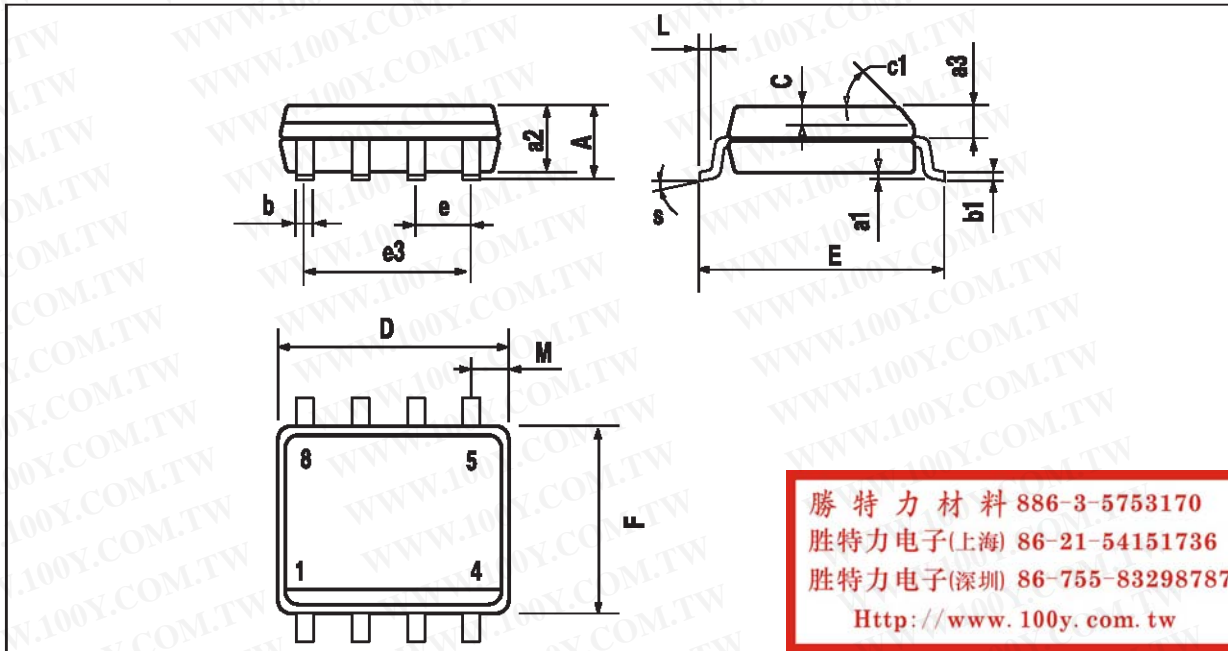

Dimensions	Millimeters			Inches		
	Min.	Typ.	Max.	Min.	Typ.	Max.
A			1.75			0.069
a1	0.1		0.25	0.004		0.010
a2			1.65			0.065
a3	0.65		0.85	0.026		0.033
b	0.35		0.48	0.014		0.019
b1	0.19		0.25	0.007		0.010
C	0.25		0.5	0.010		0.020
c1	45° (typ.)					
D	4.8		5.0	0.189		0.197
E	5.8		6.2	0.228		0.244
e		1.27			0.050	
e3		3.81			0.150	
F	3.8		4.0	0.150		0.157
L	0.4		1.27	0.016		0.050
M			0.6			0.024
S	8° (max.)					

Information furnished is believed to be accurate and reliable. However, STMicroelectronics assumes no responsibility for the consequences of use of such information nor for any infringement of patents or other rights of third parties which may result from its use. No license is granted by implication or otherwise under any patent or patent rights of STMicroelectronics. Specifications mentioned in this publication are subject to change without notice. This publication supersedes and replaces all information previously supplied. STMicroelectronics products are not authorized for use as critical components in life support devices or systems without express written approval of STMicroelectronics.

© The ST logo is a trademark of STMicroelectronics

© 1998 STMicroelectronics – Printed in Italy – All Rights Reserved

STMicroelectronics GROUP OF COMPANIES

Australia - Brazil - Canada - China - France - Germany - Italy - Japan - Korea - Malaysia - Malta - Mexico - Morocco
 The Netherlands - Singapore - Spain - Sweden - Switzerland - Taiwan - Thailand - United Kingdom - U.S.A.

© <http://www.st.com>

