

10-BIT DIGITAL-TO-ANALOG CONVERTERS

FEATURES

- 10-Bit CMOS Voltage Output DAC in an 8-Terminal Package
- 5-V Single Supply Operation
- 3-Wire Serial Interface
- High-Impedance Reference Inputs
- Voltage Output Range . . . 2 Times the Reference Input Voltage
- Internal Power-On Reset
- Low Power Consumption . . . 1.75 mW Max
- Update Rate of 1.21 MHz
- Settling Time to 0.5 LSB . . . 12.5 μ s Typ
- Monotonic Over Temperature
- Pin Compatible With the Maxim MAX515

APPLICATIONS

- Battery-Powered Test Instruments
- Digital Offset and Gain Adjustment
- Battery Operated/Remote Industrial Controls
- Machine and Motion Control Devices
- Cellular Telephones

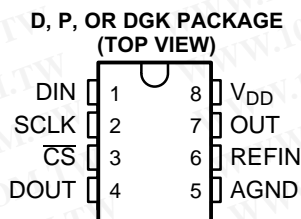

DESCRIPTION

The TLC5615 is a 10-bit voltage output digital-to-analog converter (DAC) with a buffered reference input (high impedance). The DAC has an output voltage range that is two times the reference voltage, and the DAC is monotonic. The device is simple to use, running from a single supply of 5 V. A power-on-reset function is incorporated to ensure repeatable start-up conditions.

Digital control of the TLC5615 is over a three-wire serial bus that is CMOS compatible and easily interfaced to industry standard microprocessor and microcontroller devices. The device receives a 16-bit data word to produce the analog output. The digital inputs feature Schmitt triggers for high noise immunity. Digital communication protocols include the SPI™, QSPI™, and Microwire™ standards.

The 8-terminal small-outline D package allows digital control of analog functions in space-critical applications. The TLC5615C is characterized for operation from 0°C to 70°C. The TLC5615I is characterized for operation from -40°C to 85°C.

AVAILABLE OPTIONS

T _A	PACKAGE		
	SMALL OUTLINE (1) (D)	PLASTIC SMALL OUTLINE (DGK)	PLASTIC DIP (P)
0°C to 70°C	TLC5615CD	TLC5615CDGK	TLC5615CP
40°C to 85°C	TLC5615ID	TLC5615IDGK	TLC5615IP

(1) Available in tape and reel as the TLC5615CDR and the TLC5615IDR

SPI, QSPI are trademarks of Motorola, Inc.

Microwire is a trademark of National Semiconductor Corporation.



Please be aware that an important notice concerning availability, standard warranty, and use in critical applications of Texas Instruments semiconductor products and disclaimers thereto appears at the end of this data sheet.

TLC5615C, TLC5615I

SLAS142D—OCTOBER 1996—REVISED AUGUST 2003

勝特力材料 886-3-5753170
 勝特力电子(上海) 86-21-54151736
 勝特力电子(深圳) 86-755-83298787
[Http://www.100y.com.tw](http://www.100y.com.tw)



FUNCTIONAL BLOCK DIAGRAM

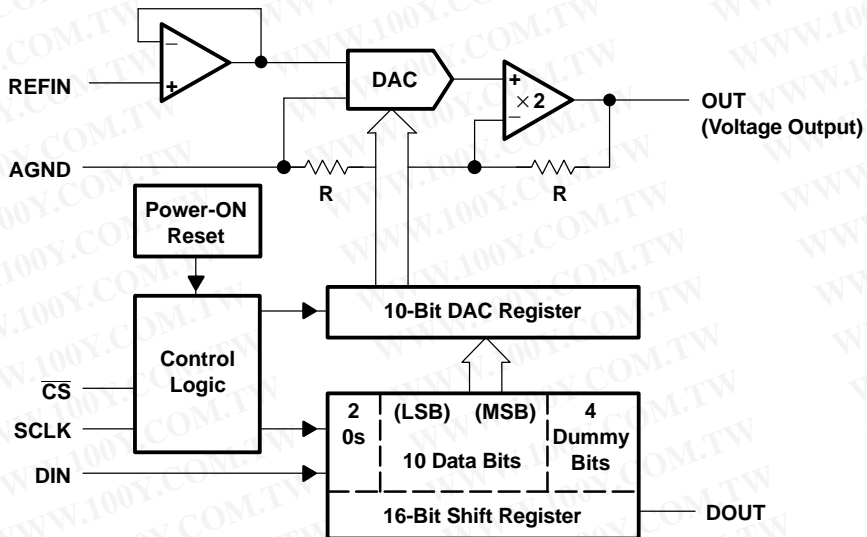

Terminal Functions

TERMINAL		I/O	DESCRIPTION
NAME	NO.		
DIN	1	I	Serial data input
SCLK	2	I	Serial clock input
\overline{CS}	3	I	Chip select, active low
DOUT	4	O	Serial data output for daisy chaining
AGND	5		Analog ground
REFIN	6	I	Reference input
OUT	7	O	DAC analog voltage output
V_{DD}	8		Positive power supply

ABSOLUTE MAXIMUM RATINGS

over operating free-air temperature range (unless otherwise noted) (1)

		UNIT
Supply voltage (V_{DD} to AGND)		7 V
Digital input voltage range to AGND		-0.3 V to $V_{DD} + 0.3$ V
Reference input voltage range to AGND		-0.3 V to $V_{DD} + 0.3$ V
Output voltage at OUT from external source		$V_{DD} + 0.3$ V
Continuous current at any terminal		± 20 mA
Operating free-air temperature range, T_A	TLC5615C	0°C to 70°C
	TLC5615I	-40°C to 85°C
Storage temperature range, T_{stg}		-65°C to 150°C
Lead temperature 1,6 mm (1/16 inch) from case for 10 seconds		260°C

(1) Stresses beyond those listed under „ absolute maximum ratings” may cause permanent damage to the device. These are stress ratings only, and functional operation of the device at these or any other conditions beyond those indicated under „ recommended operating conditions” is not implied. Exposure to absolute-maximum-rated conditions for extended periods may affect device reliability.

RECOMMENDED OPERATING CONDITIONS

		MIN	NOM	MAX	UNIT
Supply voltage, V_{DD}		4.5	5	5.5	V
High-level digital input voltage, V_{IH}		2.4			V
Low-level digital input voltage, V_{IL}				0.8	V
Reference voltage, V_{ref} to REFIN terminal		2	2.048	$V_{DD}-2$	V
Load resistance, R_L		2			k Ω
Operating free-air temperature, T_A	TLC5615C	0		70	$^{\circ}\text{C}$
	TLC5615I	40		85	$^{\circ}\text{C}$

ELECTRICAL CHARACTERISTICS

over recommended operating free-air temperature range, $V_{DD} = 5\text{ V} \pm 5\%$, $V_{ref} = 2.048\text{ V}$ (unless otherwise noted)

STATIC DAC SPECIFICATIONS							
PARAMETER		TEST CONDITIONS		MIN	TYP	MAX	UNIT
Resolution				10			bits
Integral nonlinearity, end point adjusted (INL)		$V_{ref} = 2.048\text{ V}$,	See (1)			± 1	LSB
Differential nonlinearity (DNL)		$V_{ref} = 2.048\text{ V}$,	See (2)		± 0.1	± 0.5	LSB
E_{ZS}	Zero-scale error (offset error at zero scale)	$V_{ref} = 2.048\text{ V}$,	See (3)			± 3	LSB
	Zero-scale-error temperature coefficient	$V_{ref} = 2.048\text{ V}$,	See (4)		3		ppm/ $^{\circ}\text{C}$
E_G	Gain error	$V_{ref} = 2.048\text{ V}$,	See (5)			± 3	LSB
	Gain-error temperature coefficient	$V_{ref} = 2.048\text{ V}$,	See (6)		1		ppm/ $^{\circ}\text{C}$
PSRR	Power-supply rejection ratio	Zero scale	See (7) (8)	80			dB
		Gain		80			
Analog full scale output		$R_L = 100\text{ k}\Omega$		$2V_{ref}(1023/1024)$			V

- (1) The relative accuracy or integral nonlinearity (INL), sometimes referred to as linearity error, is the maximum deviation of the output from the line between zero and full scale excluding the effects of zero code and full-scale errors (see text). Tested from code 3 to code 1024.
- (2) The differential nonlinearity (DNL), sometimes referred to as differential error, is the difference between the measured and ideal 1 LSB amplitude change of any two adjacent codes. Monotonic means the output voltage changes in the same direction (or remains constant) as a change in the digital input code. Tested from code 3 to code 1024.
- (3) Zero-scale error is the deviation from zero-voltage output when the digital input code is zero (see text).
- (4) Zero-scale-error temperature coefficient is given by: $E_{ZS}\text{ TC} = [E_{ZS}(T_{max}) - E_{ZS}(T_{min})]/V_{ref} \times 10^6/(T_{max} - T_{min})$.
- (5) Gain error is the deviation from the ideal output ($V_{ref} - 1\text{ LSB}$) with an output load of $10\text{ k}\Omega$ excluding the effects of the zero-scale error.
- (6) Gain temperature coefficient is given by: $E_G\text{ TC} = [E_G(T_{max}) - E_G(T_{min})]/V_{ref} \times 10^6/(T_{max} - T_{min})$.
- (7) Zero-scale-error rejection ratio (EZR-RR) is measured by varying the V_{DD} from 4.5 V to 5.5 V dc and measuring the proportion of this signal imposed on the zero-code output voltage.
- (8) Gain-error rejection ratio (EG-RR) is measured by varying the V_{DD} from 4.5 V to 5.5 V dc and measuring the proportion of this signal imposed on the full-scale output voltage after subtracting the zero-scale change.

VOLTAGE OUTPUT(OUT)

PARAMETER		TEST CONDITIONS		MIN	TYP	MAX	UNIT
V_O	Voltage output range	$R_L = 10\text{ k}\Omega$		0		$V_{DD}-0.4$	V
	Output load regulation accuracy	$V_{O(OUT)} = 2\text{ V}$,	$R_L = 2\text{ k}\Omega$			0.5	LSB
I_{OSC}	Output short circuit current	OUT to V_{DD} or AGND			20		mA
$V_{OL(low)}$	Output voltage, low-level	$I_{O(OUT)} \leq 5\text{ mA}$				0.25	V
$V_{OH(high)}$	Output voltage, high-level	$I_{O(OUT)} \leq -5\text{ mA}$		4.75			V
REFERENCE INPUT (REFIN)							
V_I	Input voltage			0		$V_{DD}-2$	V
r_i	Input resistance			10			M Ω

TLC5615C, TLC5615I

SLAS142D–OCTOBER 1996–REVISED AUGUST 2003

勝特力材料 886-3-5753170
 勝特力电子(上海) 86-21-54151736
 勝特力电子(深圳) 86-755-83298787
[Http://www.100y.com.tw](http://www.100y.com.tw)



VOLTAGE OUTPUT(OUT) (continued)

PARAMETER	TEST CONDITIONS	MIN	TYP	MAX	UNIT
C_i Input capacitance			5		pF
DIGITAL INPUTS (DIN, SCLK, \overline{CS})					
V_{IH} High-level digital input voltage		2.4			V
V_{IL} Low-level digital input voltage				0.8	V
I_{IH} High-level digital input current	$V_i = V_{DD}$			± 1	μA
I_{IL} Low-level digital input current	$V_i = 0$			± 1	μA
C_i Input capacitance			8		pF
DIGITAL OUTPUT (DOUT)					
V_{OH} Output voltage, high-level	$I_o = -2$ mA	$V_{DD}-1$			V
V_{OL} Output voltage, low-level	$I_o = 2$ mA			0.4	V
POWER SUPPLY					
V_{DD} Supply voltage		4.5	5	5.5	V
I_{DD} Power supply current	$V_{DD} = 5.5$ V, No load, All inputs = 0 V or V_{DD}	$V_{ref} = 0$	150	250	μA
	$V_{DD} = 5.5$ V, No load, All inputs = 0 V or V_{DD}	$V_{ref} = 2.048$ V	230	350	μA
ANALOG OUTPUT DYNAMIC PERFORMANCE					
Signal-to-noise + distortion, S/(N+D)	$V_{ref} = 1$ V _{pp} at 1 kHz + 2.048 Vdc, code = 11 1111 1111, See (1)	60			dB

(1) The limiting frequency value at 1 V_{pp} is determined by the output-amplifier slew rate.

DIGITAL INPUT TIMING REQUIRMENTS (SEE FIGURE 1)

PARAMETER	MIN	NOM	MAX	UNIT
$t_{su(DS)}$ Setup time, DIN before SCLK high	45			ns
$t_{h(DH)}$ Hold time, DIN valid after SCLK high	0			ns
$t_{su(CSS)}$ Setup time, \overline{CS} low to SCLK high	1			ns
$t_{su(CS1)}$ Setup time, \overline{CS} high to SCLK high	50			ns
$t_{h(CSH0)}$ Hold time, SCLK low to \overline{CS} low	1			ns
$t_{h(CSH1)}$ Hold time, SCLK low to \overline{CS} high	0			ns
$t_w(CS)$ Pulse duration, minimum chip select pulse width high	20			ns
$t_w(CL)$ Pulse duration, SCLK low	25			ns
$t_w(CH)$ Pulse duration, SCLK high	25			ns

OUTPUT SWITCHING CHARACTERISTICS

PARAMETER	TEST CONDITIONS	MIN	NOM	MAX	UNIT
$t_{pd(DOUT)}$ Propagation delay time, DOUT	$C_L = 50$ pF			50	ns

OPERATING CHARACTERISTICS

over recommended operating free-air temperature range, $V_{DD} = 5$ V $\pm 5\%$, $V_{ref} = 2.048$ V (unless otherwise noted)

PARAMETER	TEST CONDITIONS	MIN	TYP	MAX	UNIT
ANALOG OUTPUT DYNAMIC PERFORMANCE					
SR Output slew rate	$C_L = 100$ pF, $T_A = 25^\circ C$	$R_L = 10$ k Ω ,	0.3	0.5	V/ μs

OPERATING CHARACTERISTICS (continued)

over recommended operating free-air temperature range, $V_{DD} = 5\text{ V} \pm 5\%$, $V_{ref} = 2.048\text{ V}$ (unless otherwise noted)

PARAMETER	TEST CONDITIONS	MIN	TYP	MAX	UNIT
ANALOG OUTPUT DYNAMIC PERFORMANCE					
t_s Output settling time	To 0.5 LSB, $R_L = 10\text{ k}\Omega$, $C_L = 100\text{ pF}$, See (1)		12.5		μs
Glitch energy	DIN = All 0s to all 1s		5		$\text{nV}\cdot\text{s}$
REFERENCE INPUT (REFIN)					
Reference feedthrough	REFIN = 1 V_{pp} at 1 kHz + 2.048 Vdc (see (2))		-80		dB
Reference input bandwidth (f-3dB)	REFIN = 0.2 V_{pp} + 2.048 Vdc		30		kHz

- (1) Settling time is the time for the output signal to remain within ± 0.5 LSB of the final measured value for a digital input code change of 000 hex to 3FF hex or 3FF hex to 000 hex.
- (2) Reference feedthrough is measured at the DAC output with an input code = 000 hex and a V_{ref} input = 2.048 Vdc + 1 V_{pp} at 1 kHz.

PARAMETER MEASUREMENT INFORMATION

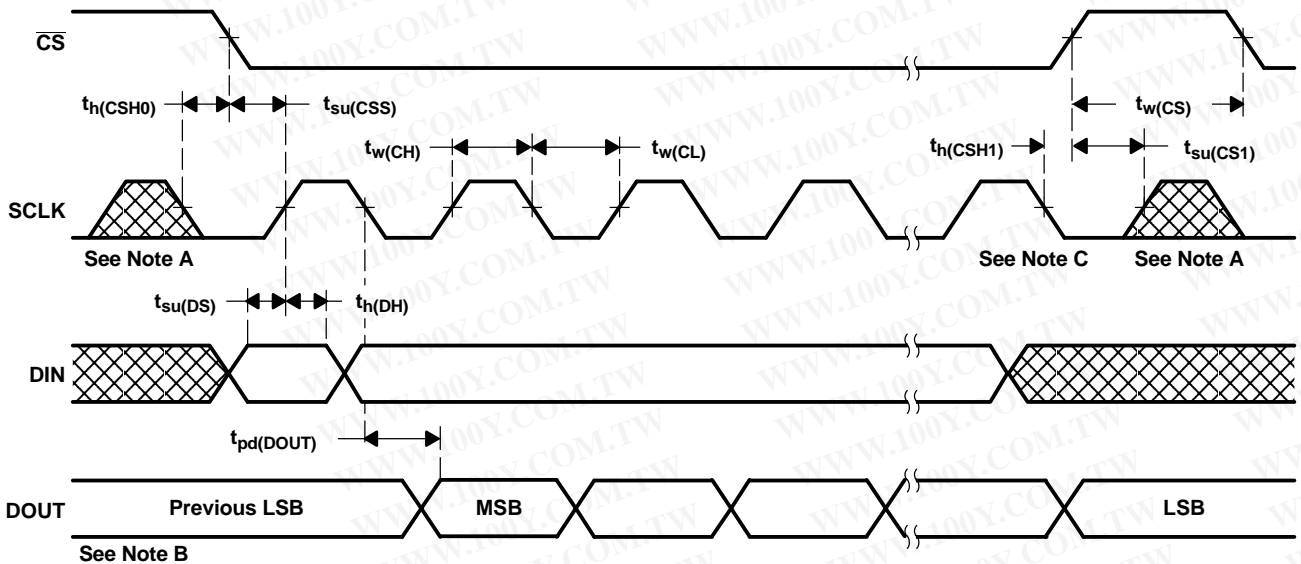

- NOTES: A. The input clock, applied at the SCLK terminal, should be inhibited low when \overline{CS} is high to minimize clock feedthrough.
B. Data input from preceding conversion cycle.
C. Sixteenth SCLK falling edge

Figure 1. Timing Diagram

TLC5615C, TLC5615I

SLAS142D—OCTOBER 1996—REVISED AUGUST 2003

TYPICAL CHARACTERISTICS

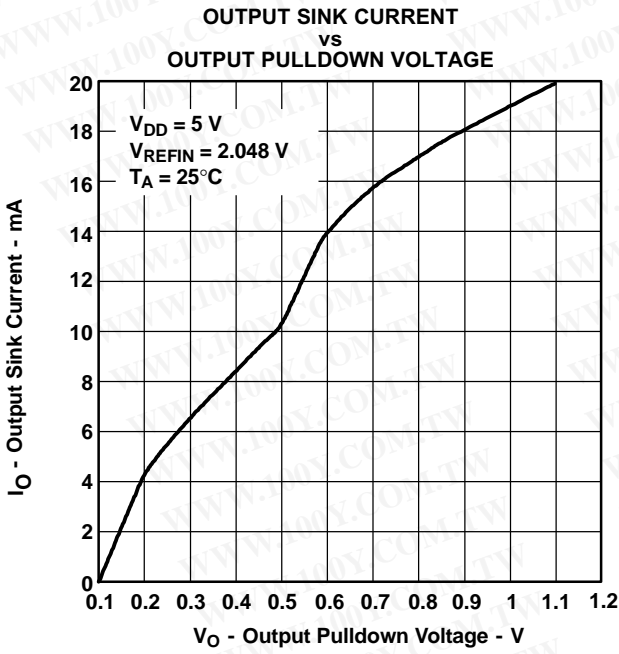

Figure 2.

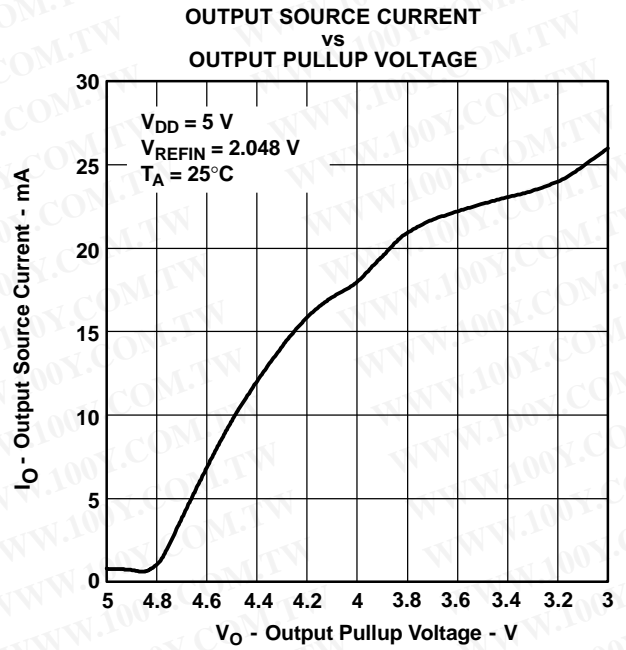

Figure 3.

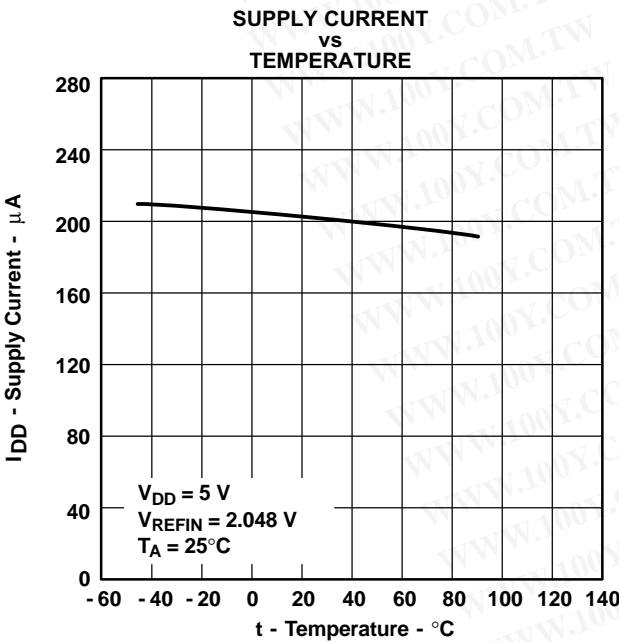

Figure 4.

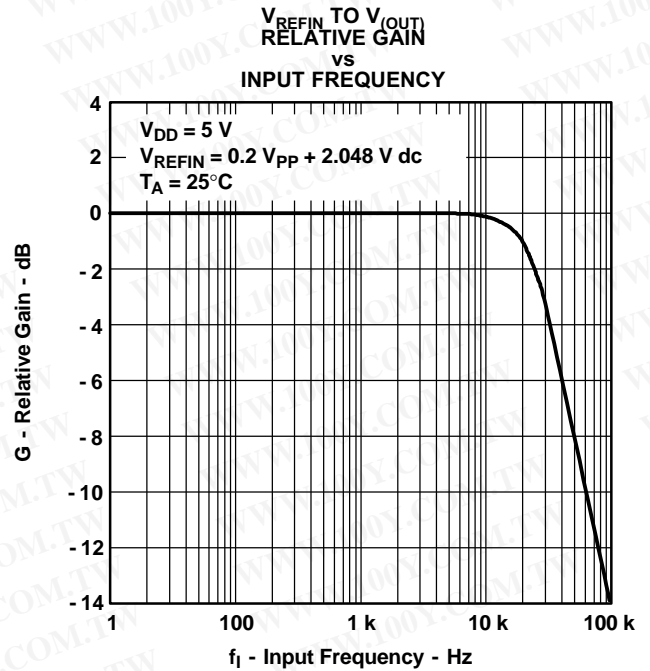
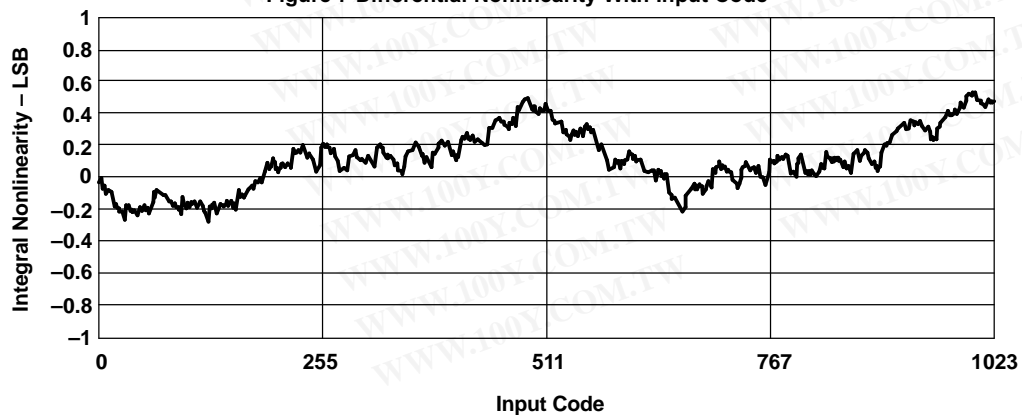
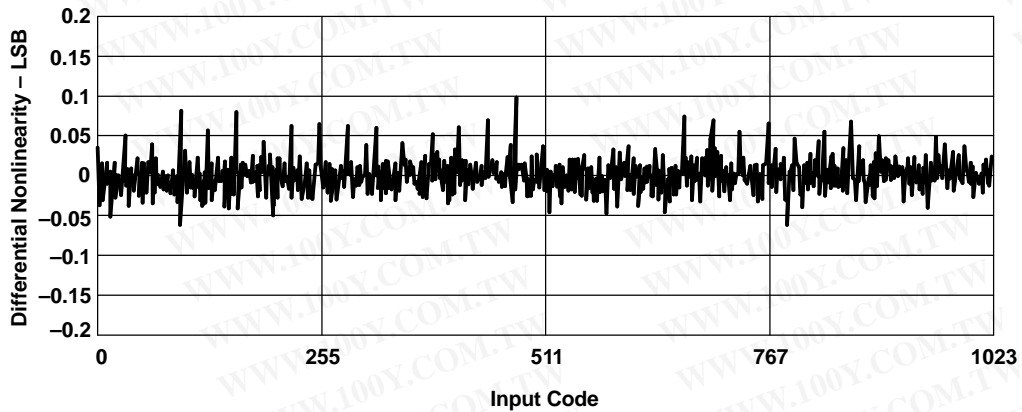
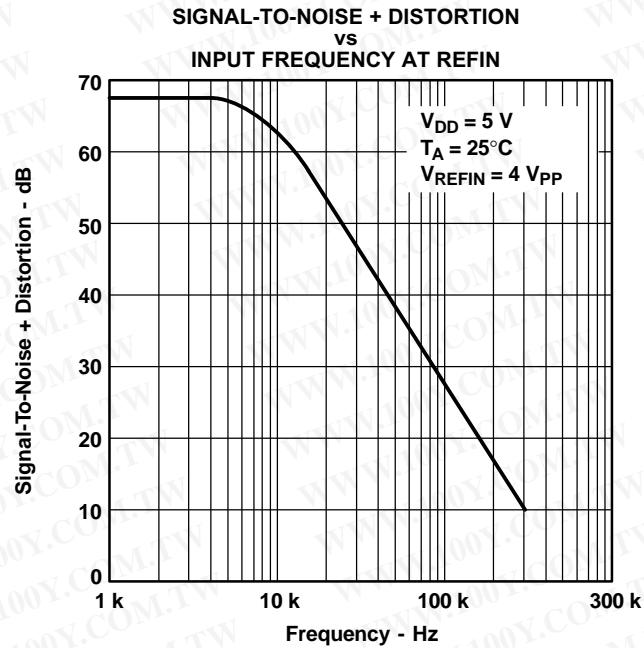

Figure 5.

TYPICAL CHARACTERISTICS (continued)



APPLICATION INFORMATION

GENERAL FUNCTION

The TLC5615 uses a resistor string network buffered with an op amp in a fixed gain of 2 to convert 10-bit digital data to analog voltage levels (see functional block diagram and Figure 9). The output of the TLC5615 is the same polarity as the reference input (see Table 1).

An internal circuit resets the DAC register to all zeros on power up.

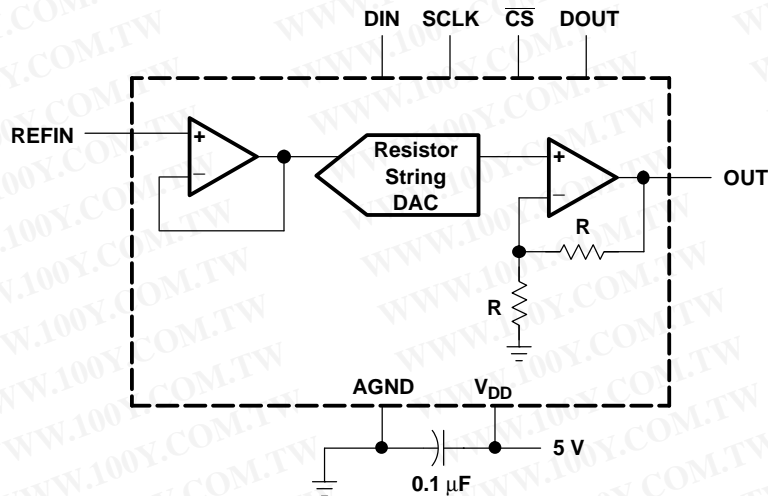

Figure 9. TLC5615 Typical Operating Circuit

Table 1. Binary Code Table (0 V to 2 V_{REFIN} Output), Gain = 2

INPUT (1)			OUTPUT
1111	1111	11(00)	$2(V_{REFIN}) \frac{1023}{1024}$
	:		:
1000	0000	01(00)	$2(V_{REFIN}) \frac{513}{1024}$
1000	0000	00(00)	$2(V_{REFIN}) \frac{512}{1024} = V_{REFIN}$
0111	1111	11(00)	$2(V_{REFIN}) \frac{511}{1024}$
	:		:
0000	0000	01(00)	$2(V_{REFIN}) \frac{1}{1024}$
0000	0000	00(00)	0 V

(1) A 10-bit data word with two bits below the LSB bit (sub-LSB) with 0 values must be written since the DAC input latch is 12 bits wide.

BUFFER AMPLIFIER

The output buffer has a rail-to-rail output with short circuit protection and can drive a 2-kΩ load with a 100-pF load capacitance. Settling time is 12.5 μs typical to within 0.5 LSB of final value.

EXTERNAL REFERENCE

The reference voltage input is buffered, which makes the DAC input resistance not code dependent. Therefore, the REFIN input resistance is 10 MΩ and the REFIN input capacitance is typically 5 pF independent of input code. The reference voltage determines the DAC full-scale output.

LOGIC INTERFACE

The logic inputs function with either TTL or CMOS logic levels. However, using rail-to-rail CMOS logic achieves the lowest power dissipation. The power requirement increases by approximately 2 times when using TTL logic levels.

SERIAL CLOCK AND UPDATE RATE

Figure 1 shows the TLC5615 timing. The maximum serial clock rate is:

$$f_{(\text{SCLK})\text{max}} = \frac{1}{t_{w(\text{CH})} + t_{w(\text{CL})}}$$

or approximately 14 MHz. The digital update rate is limited by the chip-select period, which is:

$$t_{p(\text{CS})} = 16 \times (t_{w(\text{CH})} + t_{w(\text{CL})}) + t_{w(\text{CS})}$$

and is equal to 820 ns which is a 1.21 MHz update rate. However, the DAC settling time to 10 bits of 12.5 μs limits the update rate to 80 kHz for full-scale input step transitions.

SERIAL INTERFACE

When chip select ($\overline{\text{CS}}$) is low, the input data is read into a 16-bit shift register with the input data clocked in most significant bit first. The rising edge of the SCLK input shifts the data into the input register.

The rising edge of $\overline{\text{CS}}$ then transfers the data to the DAC register. When $\overline{\text{CS}}$ is high, input data cannot be clocked into the input register. All $\overline{\text{CS}}$ transitions should occur when the SCLK input is low.

If the daisy chain (cascading) function (see daisy-chaining devices section) is not used, a 12-bit input data sequence with the MSB first can be used as shown in Figure 10:

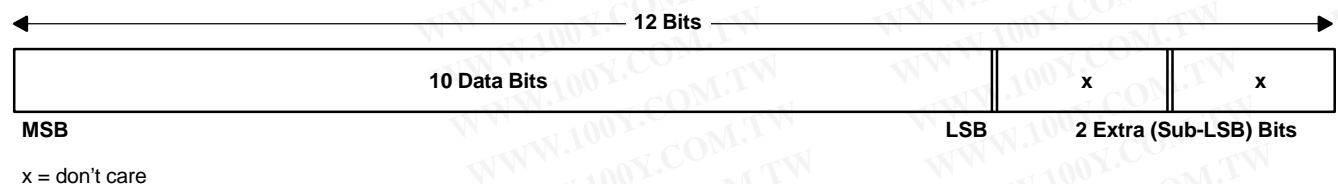

Figure 10. 12-Bit Input Data Sequence

or 16 bits of data can be transferred as shown in Figure 11 with the 4 upper dummy bits first.

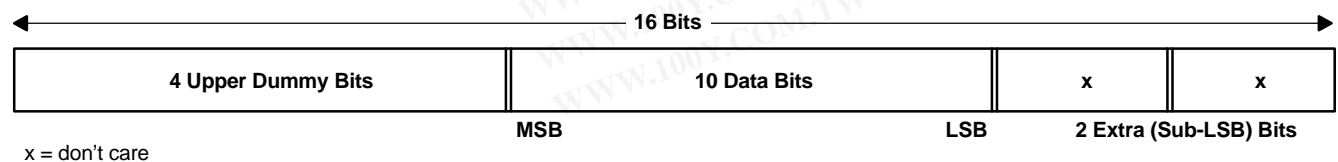

Figure 11. 16-Bit Input Data Sequence

TLC5615C, TLC5615I

SLAS142D–OCTOBER 1996–REVISED AUGUST 2003

The data from DOUT requires 16 falling edges of the input clock and, therefore, requires an extra clock width. When daisy chaining multiple TLC5615 devices, the data requires 4 upper dummy bits because the data transfer requires 16 input-clock cycles plus one additional input-clock falling edge to clock out the data at the DOUT terminal (see Figure 1).

The two extra (sub-LSB) bits are always required to provide hardware and software compatibility with 12-bit data converter transfers.

The TLC5615 three-wire interface is compatible with the SPI, QSPI[†], and Microwire serial standards. The hardware connections are shown in Figure 12 and Figure 13.

The SPI and Microwire interfaces transfer data in 8-bit bytes, therefore, two write cycles are required to input data to the DAC. The QSPI interface, which has a variable input data length from 8 to 16 bits, can load the DAC input register in one write cycle.

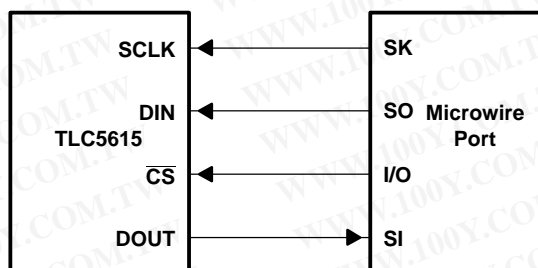

NOTE A: The DOUT-SI connection is not required for writing to the TLC5615 but may be used for verifying data transfer if desired.

Figure 12. Microwire Connection

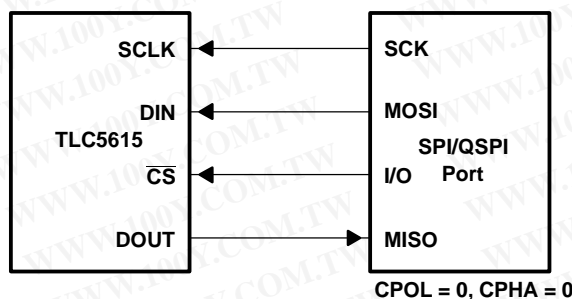

NOTE A: The DOUT-MISO connection is not required for writing to the TLC5615 but may be used for verifying data transfer.

Figure 13. SPI/QSPI Connection

DAISY-CHAINING DEVICES

DACs can be daisy-chained by connecting the DOUT terminal of one device to the DIN of the next device in the chain, providing that the setup time, $t_{su(CSS)}$, (\overline{CS} low to SCLK high) is greater than the sum of the setup time, $t_{su(DS)}$, plus the propagation delay time, $t_{pd(DOUT)}$, for proper timing (see digital input timing requirements section). The data at DIN appears at DOUT, delayed by 16 clock cycles plus one clock width. DOUT is a totem-poled output for low power. DOUT changes on the SCLK falling edge when \overline{CS} is low. When \overline{CS} is high, DOUT remains at the value of the last data bit and does not go into a high-impedance state.

LINEARITY, OFFSET, AND GAIN ERROR USING SINGLE ENDED SUPPLIES

When an amplifier is operated from a single supply, the voltage offset can still be either positive or negative. With a positive offset, the output voltage changes on the first code change. With a negative offset the output voltage may not change with the first code depending on the magnitude of the offset voltage.

The output amplifier attempts to drive the output to a negative voltage. However, because the most negative supply rail is ground, the output cannot drive below ground and clamps the output at 0 V.

The output voltage then remains at zero until the input code value produces a sufficient positive output voltage to overcome the negative offset voltage, resulting in the transfer function shown in Figure 14.

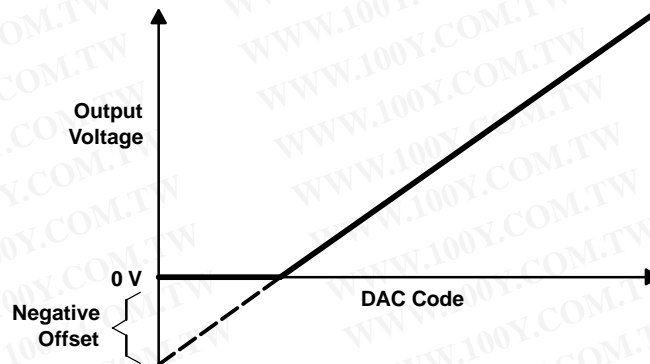

Figure 14. Effect of Negative Offset (Single Supply)

This offset error, not the linearity error, produces this breakpoint. The transfer function would have followed the dotted line if the output buffer could drive below the ground rail.

For a DAC, linearity is measured between zero-input code (all inputs 0) and full-scale code (all inputs 1) after offset and full scale are adjusted out or accounted for in some way. However, single supply operation does not allow for adjustment when the offset is negative due to the breakpoint in the transfer function. So the linearity is measured between full-scale code and the lowest code that produces a positive output voltage. For the TLC5615, the zero-scale (offset) error is plus or minus 3 LSB maximum. The code is calculated from the maximum specification for the negative offset.

POWER-SUPPLY BYPASSING AND GROUND MANAGEMENT

Printed-circuit boards that use separate analog and digital ground planes offer the best system performance. Wire-wrap boards do not perform well and should not be used. The two ground planes should be connected together at the low-impedance power-supply source. The best ground connection may be achieved by connecting the DAC AGND terminal to the system analog ground plane making sure that analog ground currents are well managed and there are negligible voltage drops across the ground plane.

A 0.1- μ F ceramic-capacitor bypass should be connected between V_{DD} and AGND and mounted with short leads as close as possible to the device. Use of ferrite beads may further isolate the system analog supply from the digital power supply.

Figure 15 shows the ground plane layout and bypassing technique.

TLC5615C, TLC5615I

SLAS142D—OCTOBER 1996—REVISED AUGUST 2003

勝特力材料 886-3-5753170
勝特力电子(上海) 86-21-54151736
勝特力电子(深圳) 86-755-83298787
[Http://www.100y.com.tw](http://www.100y.com.tw)

 **TEXAS
INSTRUMENTS**
www.ti.com

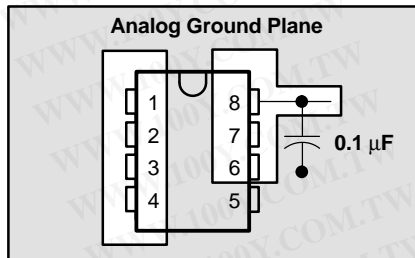

Figure 15. Power-Supply Bypassing

SAVING POWER

Setting the DAC register to all 0s minimizes power consumption by the reference resistor array and the output load when the system is not using the DAC.

AC CONSIDERATIONS

Digital Feedthrough

Even with \overline{CS} high, high-speed serial data at any of the digital input or output terminals may couple through the DAC package internal stray capacitance and appear at the DAC analog output as digital feedthrough. Digital feedthrough is tested by holding \overline{CS} high and transmitting 01010101 from DIN to DOUT.

Analog Feedthrough

Higher frequency analog input signals may couple to the output through internal stray capacitance. Analog feedthrough is tested by holding \overline{CS} high, setting the DAC code to all 0s, sweeping the frequency applied to REFIN, and monitoring the DAC output.

P (R-PDIP-T8)

PLASTIC DUAL-IN-LINE

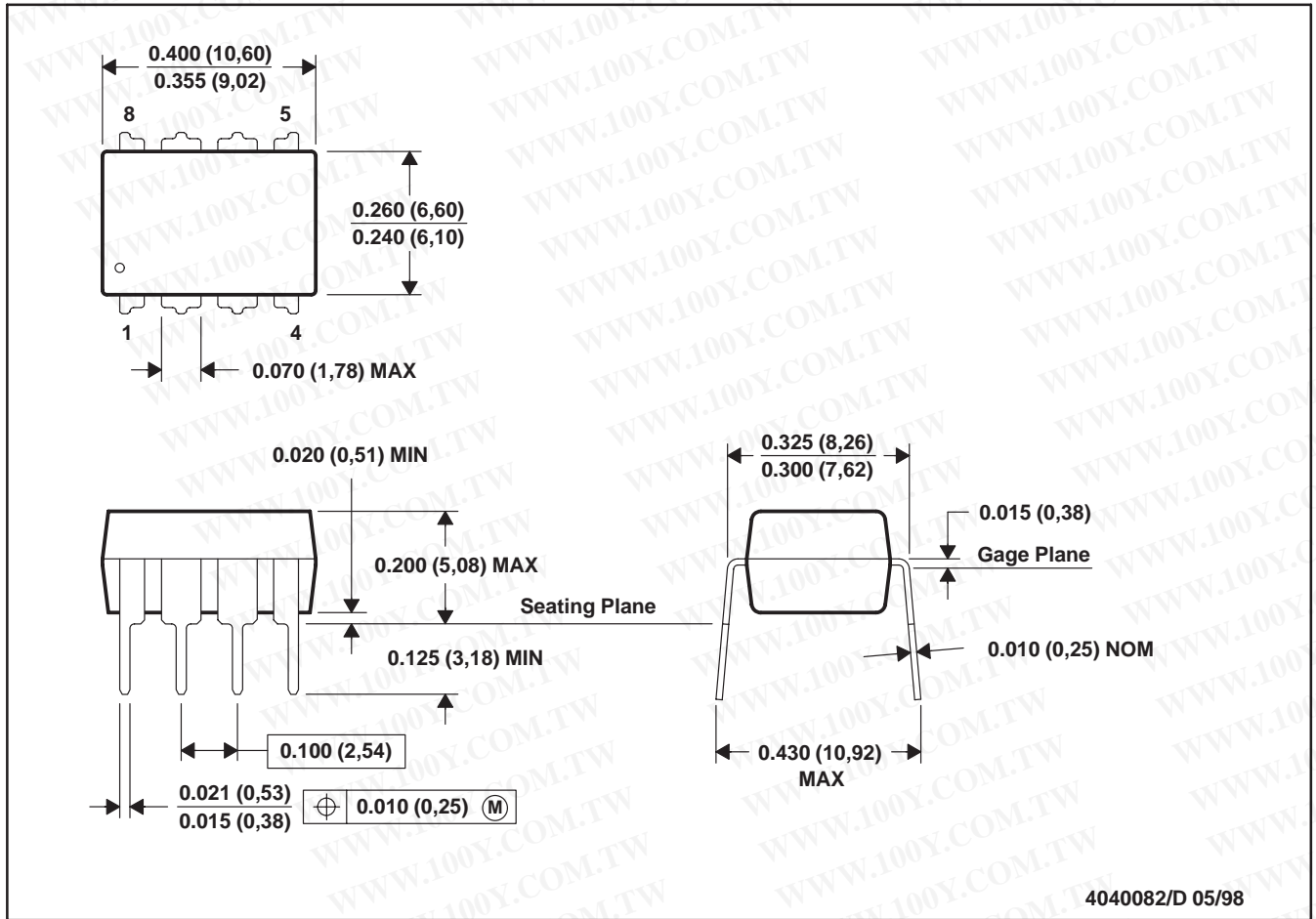

- NOTES:
- A. All linear dimensions are in inches (millimeters).
 - B. This drawing is subject to change without notice.
 - C. Falls within JEDEC MS-001

For the latest package information, go to http://www.ti.com/sc/docs/package/pkg_info.htm

DGK (R-PDSO-G8)

PLASTIC SMALL-OUTLINE PACKAGE

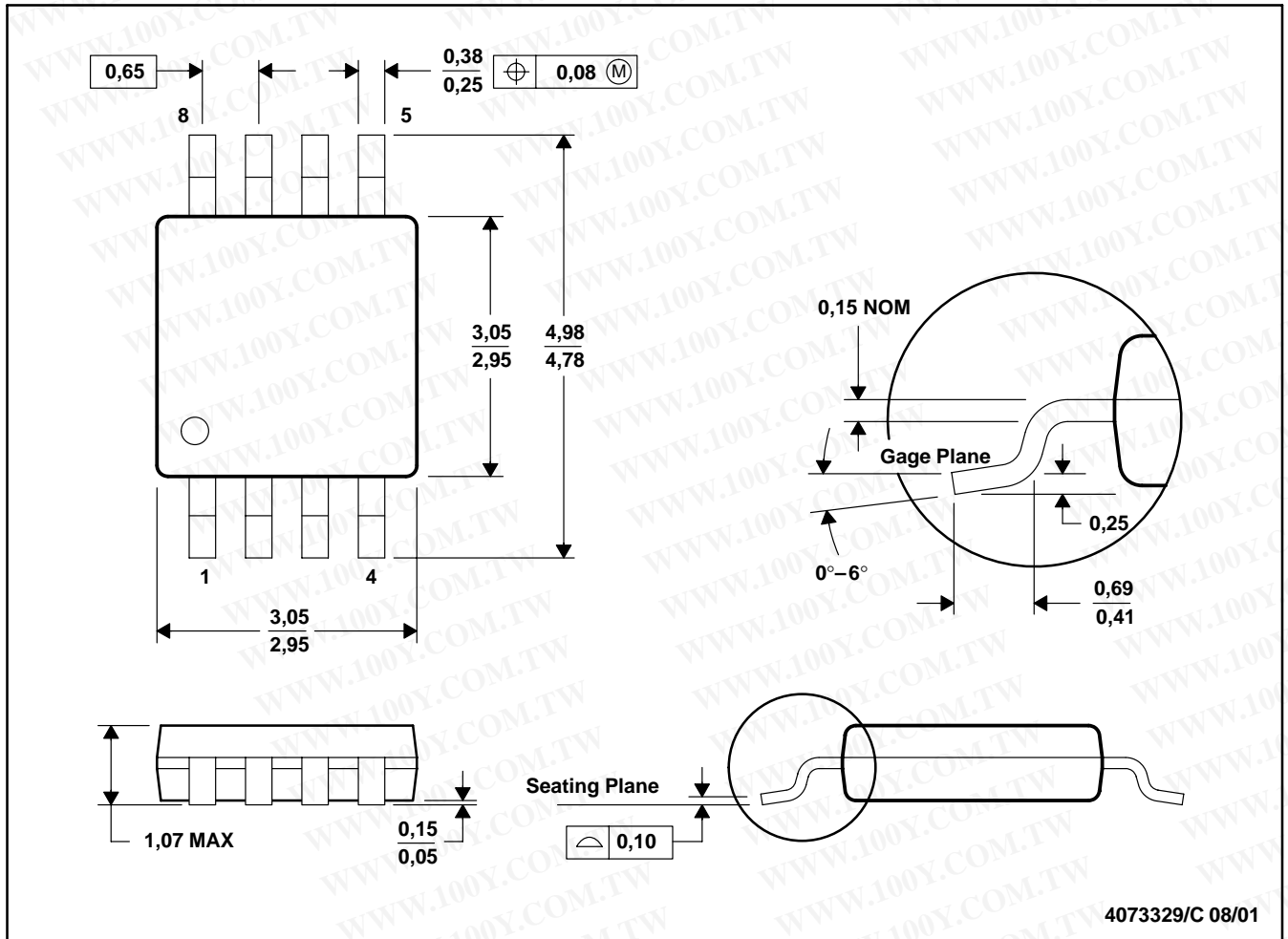

- NOTES:
- A. All linear dimensions are in millimeters.
 - B. This drawing is subject to change without notice.
 - C. Body dimensions do not include mold flash or protrusion.
 - D. Falls within JEDEC MO-187

D (R-PDSO-G**)

PLASTIC SMALL-OUTLINE PACKAGE

8 PINS SHOWN

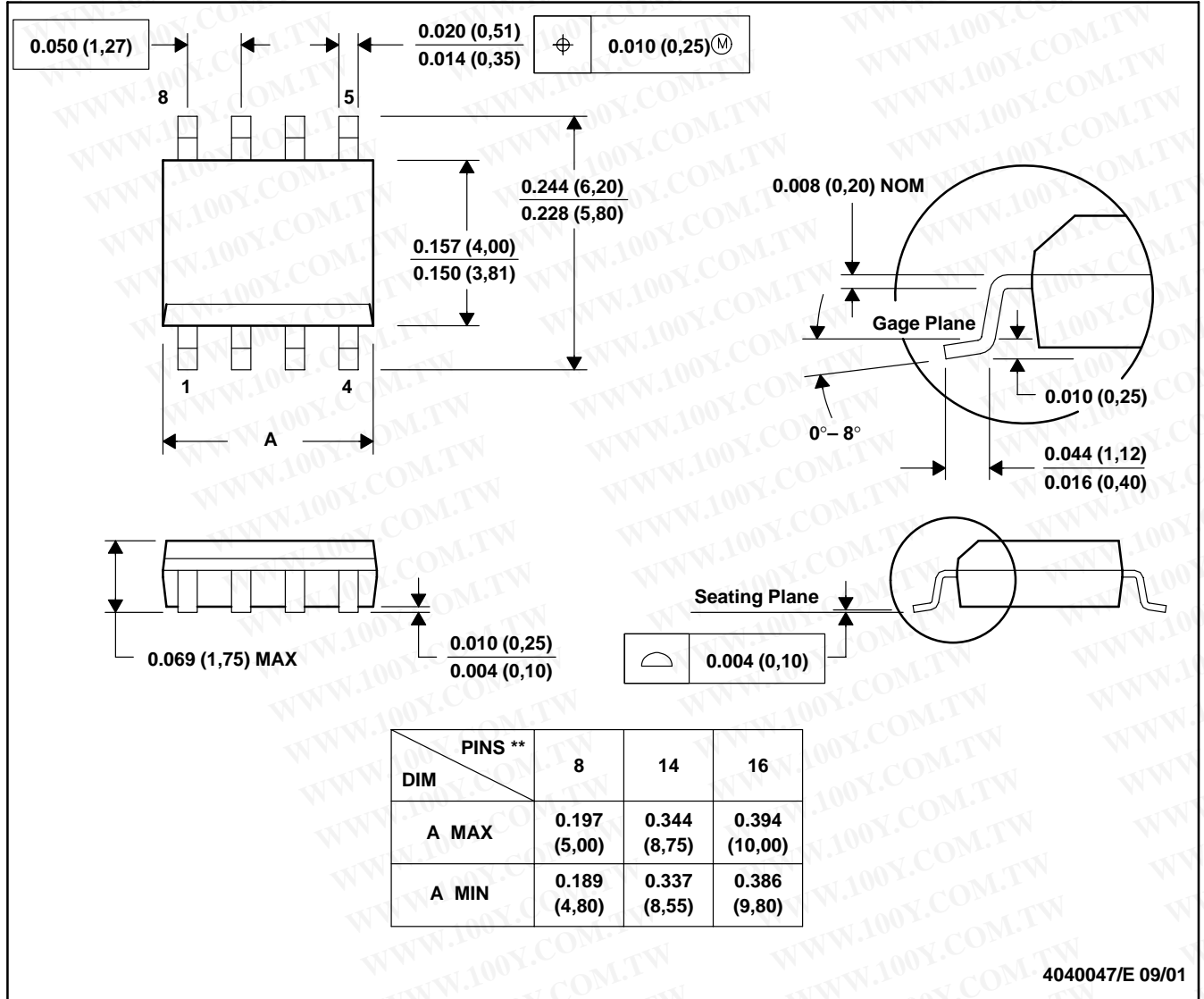

- NOTES: A. All linear dimensions are in inches (millimeters).
 B. This drawing is subject to change without notice.
 C. Body dimensions do not include mold flash or protrusion, not to exceed 0.006 (0,15).
 D. Falls within JEDEC MS-012

勝特力材料 886-3-5753170
勝特力电子(上海) 86-21-54151736
勝特力电子(深圳) 86-755-83298787
[Http://www.100y.com.tw](http://www.100y.com.tw)

IMPORTANT NOTICE

Texas Instruments Incorporated and its subsidiaries (TI) reserve the right to make corrections, modifications, enhancements, improvements, and other changes to its products and services at any time and to discontinue any product or service without notice. Customers should obtain the latest relevant information before placing orders and should verify that such information is current and complete. All products are sold subject to TI's terms and conditions of sale supplied at the time of order acknowledgment.

TI warrants performance of its hardware products to the specifications applicable at the time of sale in accordance with TI's standard warranty. Testing and other quality control techniques are used to the extent TI deems necessary to support this warranty. Except where mandated by government requirements, testing of all parameters of each product is not necessarily performed.

TI assumes no liability for applications assistance or customer product design. Customers are responsible for their products and applications using TI components. To minimize the risks associated with customer products and applications, customers should provide adequate design and operating safeguards.

TI does not warrant or represent that any license, either express or implied, is granted under any TI patent right, copyright, mask work right, or other TI intellectual property right relating to any combination, machine, or process in which TI products or services are used. Information published by TI regarding third-party products or services does not constitute a license from TI to use such products or services or a warranty or endorsement thereof. Use of such information may require a license from a third party under the patents or other intellectual property of the third party, or a license from TI under the patents or other intellectual property of TI.

Reproduction of information in TI data books or data sheets is permissible only if reproduction is without alteration and is accompanied by all associated warranties, conditions, limitations, and notices. Reproduction of this information with alteration is an unfair and deceptive business practice. TI is not responsible or liable for such altered documentation.

Resale of TI products or services with statements different from or beyond the parameters stated by TI for that product or service voids all express and any implied warranties for the associated TI product or service and is an unfair and deceptive business practice. TI is not responsible or liable for any such statements.

Following are URLs where you can obtain information on other Texas Instruments products and application solutions:

Products		Applications	
Amplifiers	amplifier.ti.com	Audio	www.ti.com/audio
Data Converters	dataconverter.ti.com	Automotive	www.ti.com/automotive
DSP	dsp.ti.com	Broadband	www.ti.com/broadband
Interface	interface.ti.com	Digital Control	www.ti.com/digitalcontrol
Logic	logic.ti.com	Military	www.ti.com/military
Power Mgmt	power.ti.com	Optical Networking	www.ti.com/opticalnetwork
Microcontrollers	microcontroller.ti.com	Security	www.ti.com/security
		Telephony	www.ti.com/telephony
		Video & Imaging	www.ti.com/video
		Wireless	www.ti.com/wireless

Mailing Address: Texas Instruments
Post Office Box 655303 Dallas, Texas 75265

Copyright © 2003, Texas Instruments Incorporated