

TOSHIBA

IGBT/Power MOSFET Gate Drive Photo-IC Couplers TLP250(INV)/TLP250F(INV)

NEW PRODUCT GUIDE

勝特力材料 886-3-5753170
勝特力电子(上海) 86-21-54151736
勝特力电子(深圳) 86-755-83298787
[Http://www.100y.com.tw](http://www.100y.com.tw)

IGBT / POWER MOSFET GATE DRIVE PHOTO-IC COUPLERS TLP250 (INV) / TLP250F (INV)



The Toshiba TLP250 (INV) and TLP250F (INV) are 8-pin photocouplers designed exclusively for use in IGBT (isolated-gate bipolar transistor) drive applications. These photocouplers are capable of driving the gates of IGBTs and power MOSFETs directly (for which the addition of a gate resistor is necessary). The photo-IC couplers are housed in compact packages. This, combined with their ability to drive IGBTs and power MOSFETs directly, makes system design easier, allows simpler circuit configurations and improves system reliability.

Applications

- IGBT gate drive
- Power MOSFET gate drive
- Inverter
- Servo motor control
- UPS
- Induction heater

Features

- Input threshold current: $I_F = 5 \text{ mA}$ (max)
- Supply voltage: 10 V ~ 35 V
- Output peak current: 2.0 A (max)
- Response speed: 0.5 μs (max)
- $|t_{pHL} - t_{pLH}|$: 0.4 μs (max)
- Isolation voltage: 2500 V_{rms} (min)
- UL-recognized
- D4 option type: VDE-approved

Note:
 If a VDE0884-approved device is required, please specify option D4.

Pin Configuration

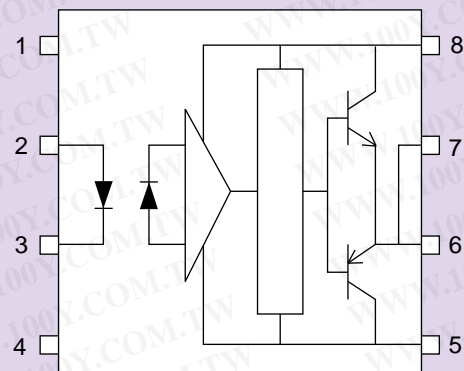

- 1: NC
- 2: LED ANODE
- 3: LED CATHODE
- 4: NC
- 5: GND
- 6: V_O (output)
- 7: V_O
- 8: V_{CC}

Truth Table

		Tr1	Tr2
LED	ON	ON	OFF
INPUT	OFF	OFF	ON

Peak output current — frequency

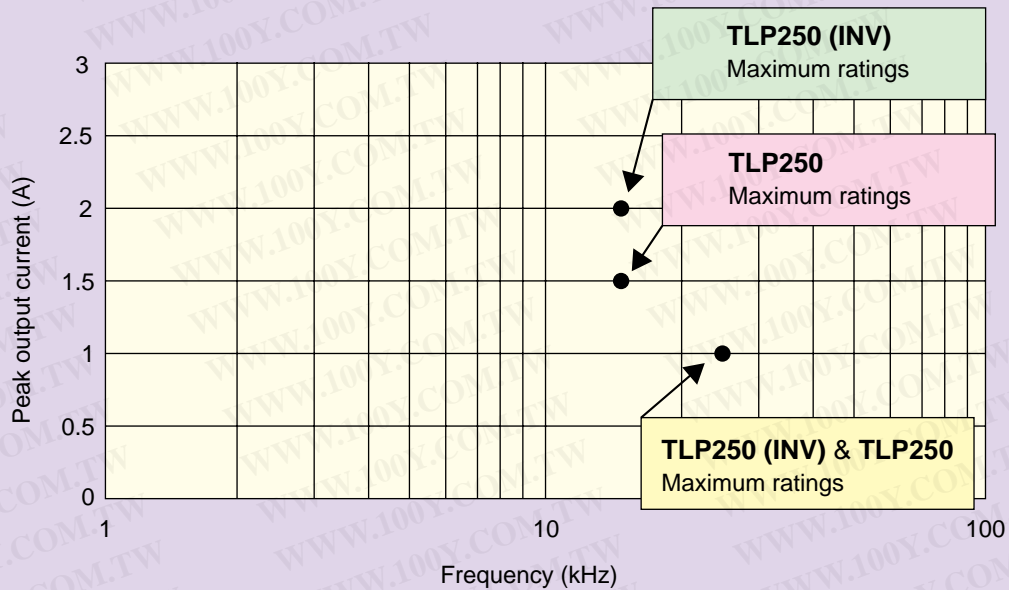

● TLP250 (INV) vs. TLP250

Parameter	Symbol	Conditions	TLP250 (INV)	TLP250	Unit
H-level Output Current	I_{OPH}	$I_F = 10 \text{ mA}$, $V_{8-6} = 4 \text{ V}$ $V_{CC} = 30 \text{ V}$	1.0 (min)	0.5 (min)	A
L-Level Output Current	I_{OPL}	$I_F = 0$, $V_{6-5} = -2.5 \text{ V}$ $V_{CC} = 30 \text{ V}$	1.0 (min)	0.5 (min)	A
Switching Time Dispersion between ON and OFF	$ t_{pHL} - t_{pLH} $	$R_L = 20 \Omega$, $C_L = 10 \text{ nF}$	0.45 (max)	— (max)	μs
Common Mode Transient Immunity for High-Level Output	CM_H	$V_{CM} = 1000 \text{ V}_{p-p}$, $I_F = 8 \text{ mA}$, $V_{CC} = 30 \text{ V}$, $T_a = 25 \text{ }^\circ\text{C}$	15,000 (min)	5,000 (min)	$\text{V}/\mu\text{s}$
Common Mode Transient Immunity for Low-Level Output	CM_L	$V_{CM} = 1000 \text{ V}_{p-p}$, $I_F = 0 \text{ mA}$, $V_{CC} = 30 \text{ V}$, $T_a = 25 \text{ }^\circ\text{C}$	15,000 (min)	5,000 (min)	$\text{V}/\mu\text{s}$

● UL-recognized: UL1577, File No. E67349

● Option (D4) type

VDE-approved: DIN VDE0884/16.92, Certificate No. 76823

	TLP250	TLP250F*
Maximum Operating Insulation Voltage	630 Vpk	840 Vpk
Highest Permissible Over Voltage	4000 Vpk	6000 Vpk

	TLP250	TLP250F*
Creepage distance	6.4 mm	8.0 mm
Clearance	6.4 mm	8.0 mm

Note:

When a VDE0884-approved device is required, please specify option D4.

* Making an application

Absolute Maximum ratings

(Ta = 25°C)

Parameter		Symbol	Rating	Unit	
LED	Forward Current	I _F	20	mA	
	Forward Current Derating (Ta ≥ 70°C)	ΔI _F /ΔTa	-0.36	mA/°C	
	Reverse Voltage	V _R	5	V	
Detector	H Peak Output Current	(PW ≤ 2.5 μs, f = 15 kHz) (Note 2)	I _{OPH}	-1.5	A
		(PW ≤ 1 μs, f = 15 kHz) (Note 2)		-2.0	
	L Peak Output Current	(PW ≤ 2.5 μs, f = 15 kHz) (Note 2)	I _{OPL}	+1.5	A
		(PW ≤ 1 μs, f = 15 kHz) (Note 2)		+2.0	
	Output Voltage		V _O	35	V
	Output Voltage Derating (Ta ≥ 70°C)		ΔV _O /ΔTa	-0.73	V/°C
	Supply Voltage		V _{CC}	35	V
	Supply Voltage Derating (Ta ≥ 70°C)		ΔV _{CC} /ΔTa	-0.73	V/°C
Operating Frequency (Note 3)		f	25	kHz	
Operating Temperature Range		Topr	-20 ~ 85	°C	
Storage Temperature Range		Tstg	-55 ~ 125	°C	
Isolation Voltage (AC, 1 minute, R/H ≤ 60%, Ta = 25°C)		BVs	2500	V _{rms}	

Note 2: Exponential Waveform

Note 3: Exponential Waveform, I_{OPH} ≤ -1.0 A (≤ 2.5 μs), I_{OPL} ≤ +1.0 A (≤ 2.5 μs)

Note 5: A ceramic capacitor (0.1 μF) should be connected between pin 8 and pin 5 to stabilize the operation of the high-gain linear amplifier. Failure to provide this bypass may impair the switching properties. The total lead length between capacitor and coupler should not exceed 1 cm.

Electrical Characteristics

(Ta = -20° ~ 70°C unless otherwise specified)

Parameter		Symbol	Conditions	Min	Typ.	Max	Unit
Input Forward Voltage		V _F	I _F = 10 mA, Ta = 25°C	—	1.6	1.8	V
Temperature Coefficient of Forward Voltage		ΔV _F /ΔTa	I _F = 10 mA	—	-2.0	—	mV/°C
Input Reverse Voltage		I _R	V _R = 5 V, Ta = 25°C	—	—	10	μA
Output Current	H Level	I _{OPH}	V _{CC} = 30 V (*1)	I _F = 10 mA, V ₈₋₆ = 4 V	-0.5	-1.5	A
				TLP250 (INV)	-1.0	-1.5	
	L Level	I _{OPL}	V _{CC} = 30 V (*1)	I _F = 0, V ₆₋₅ = -2.5 V	0.5	2	—
				TLP250 (INV)	1.0	2	
Output Voltage	H Level	V _{OH}	V _{CC} = 15 V V _{EE} = -15 V R _L = 200 Ω	I _F = 5 mA	11	12.8	V
	L Level	V _{OL}		V _F = 0.8 V	—	-14.2	
Supply Current	H Level	I _{CCH}	V _{CC} = 30 V	I _F = 10 mA	—	7	mA
	L Level	I _{CCL}		V _F = 0.8 V	—	7.5	
Threshold Input Current	Output L → H	I _{FLH}	V _{CC1} = +15 V, V _{EE1} = -15 V R _L = 200 Ω, V _O > 0 V	—	1.2	5	mA
Threshold Input Voltage	Output H → L	V _{FHL}	V _{CC1} = +15 V, V _{EE1} = -15 V R _L = 200 Ω, V _O < 0 V	0.8	—	—	V
Supply Voltage		V _{CC}		10	—	35	V

* All typical values are at Ta = 25°C (*1): Duration of I/O time ≤ 50 μs

Switching Characteristics

(Ta = -20° ~ 70°C unless otherwise specified)

Parameter	Symbol	Conditions	Min	Typ.	Max	Unit
Propagation Delay Time	L → H	$I_F = 8 \text{ mA}$ $V_{CC} = 15 \text{ V}, V_{EE} = -15 \text{ V},$ $R_L = 20 \Omega, C_L = 10 \text{ nF}$	0.05	0.15	0.5	μs
	H → L		0.05	0.15	0.5	
Switching Time Dispersion between ON and OFF	$ \tau_{pHL} - \tau_{pLH} $		—	—	0.45	
Common Mode Transient Immunity for High-Level Output	CM_H	$V_{CM} = 1000 \text{ V}_{p-p}, I_F = 8 \text{ mA},$ $V_{CC} = 30 \text{ V}, T_a = 25 \text{ }^\circ\text{C}$	15,000	—	—	$\text{V}/\mu\text{s}$
Common Mode Transient Immunity for Low-Level Output	CM_L	$V_{CM} = 1000 \text{ V}_{p-p}, I_F = 0 \text{ mA},$ $V_{CC} = 30 \text{ V}, T_a = 25 \text{ }^\circ\text{C}$	15,000	—	—	$\text{V}/\mu\text{s}$

勝特力材料 886-3-5753170
 勝特力电子(上海) 86-21-54151736
 勝特力电子(深圳) 86-755-83298787
[Http://www.100y.com.tw](http://www.100y.com.tw)

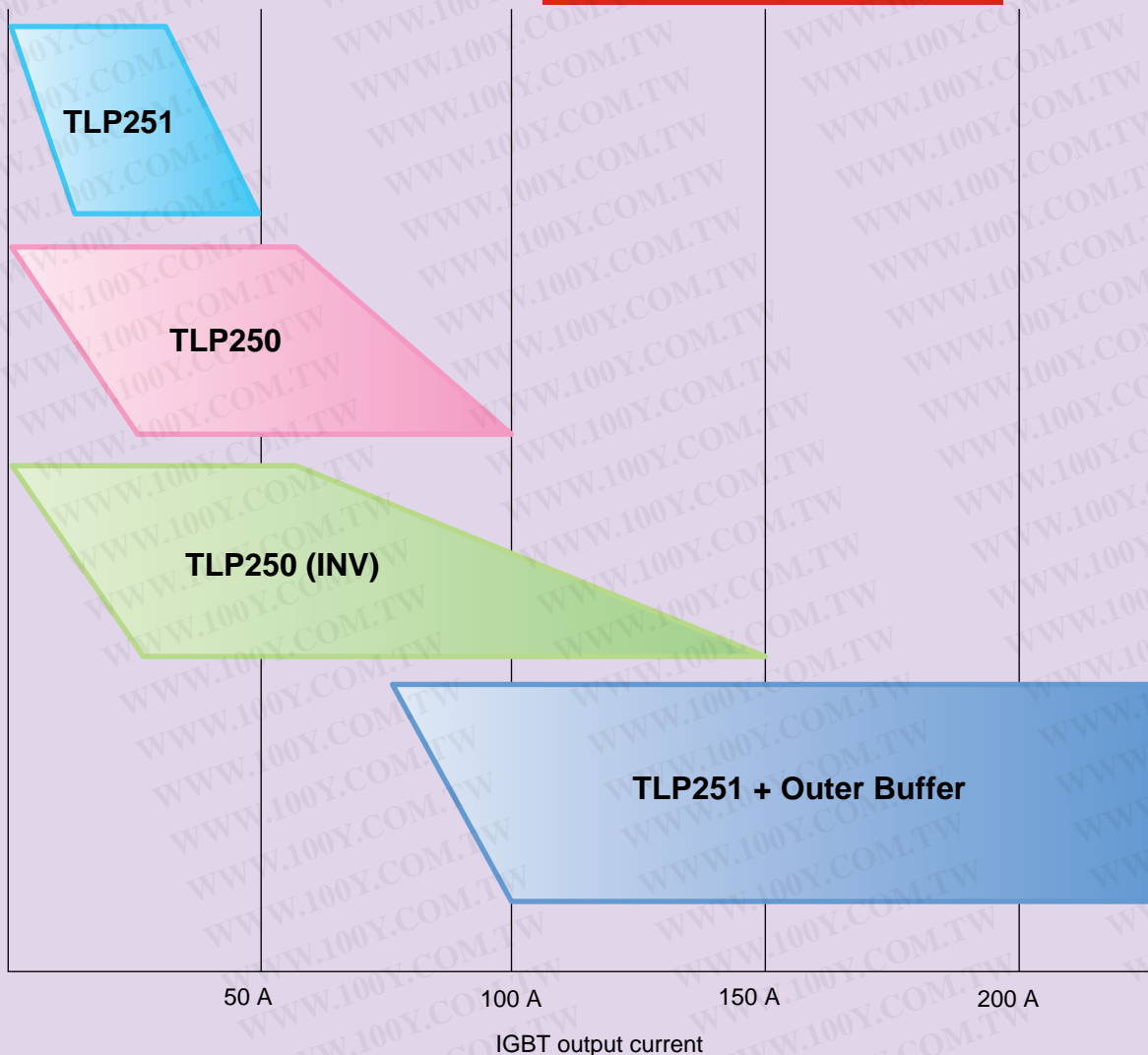

TLP250

$V_{CC} - T_a$

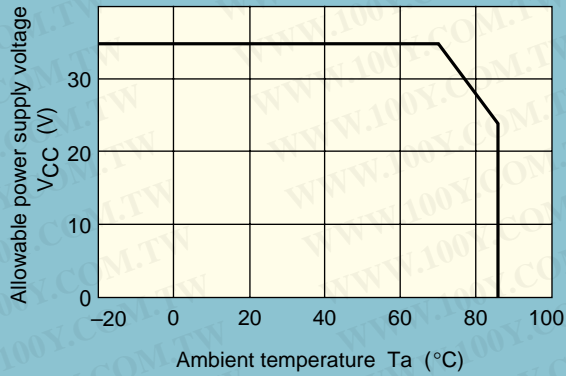

TLP250, TLP250 (INV)

$I_{OPH}, I_{OPL} - T_a$

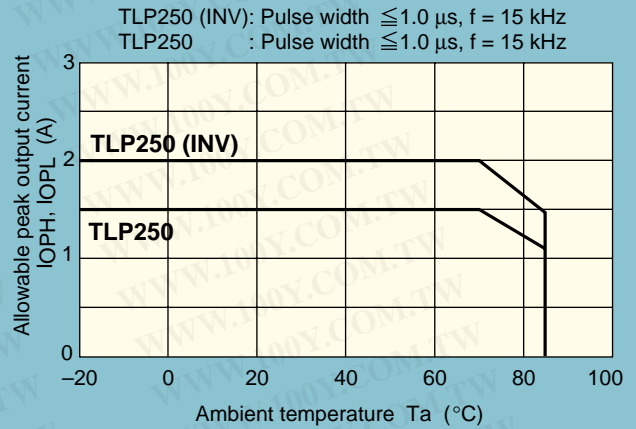

TLP250, TLP250 (INV)

$V_{OL} - I_{OL}$

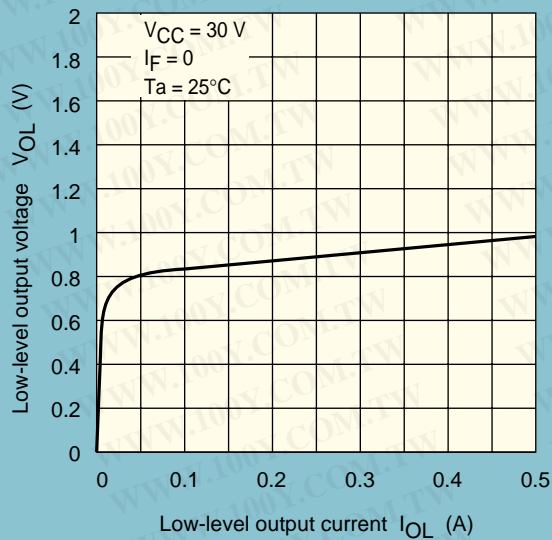

TLP250, TLP250 (INV)

$V_{OH} - I_{OH}$

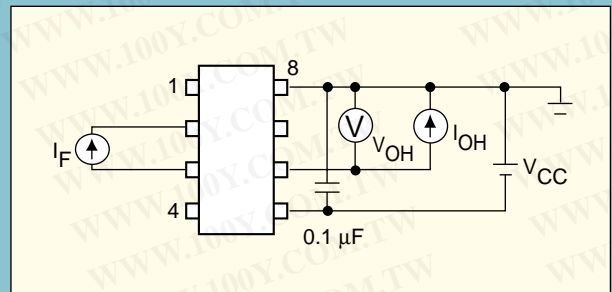
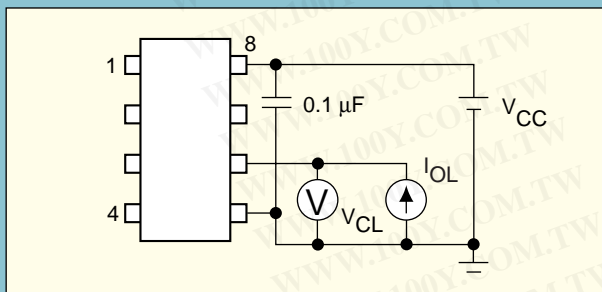
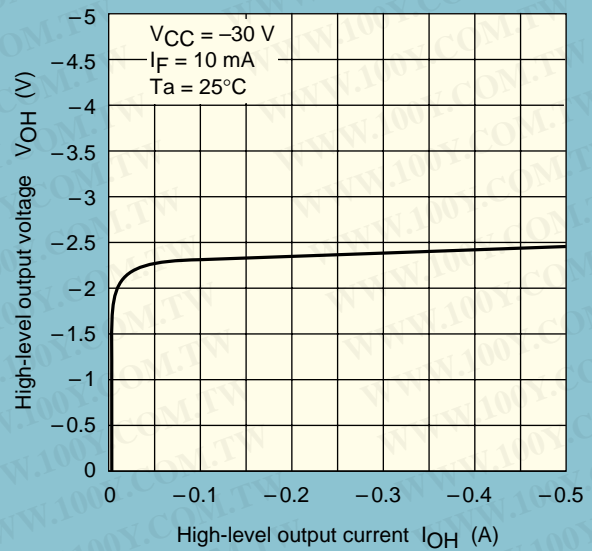

TLP250 (INV)

$I_{OPH}, I_{OPL} - V_{CC}$

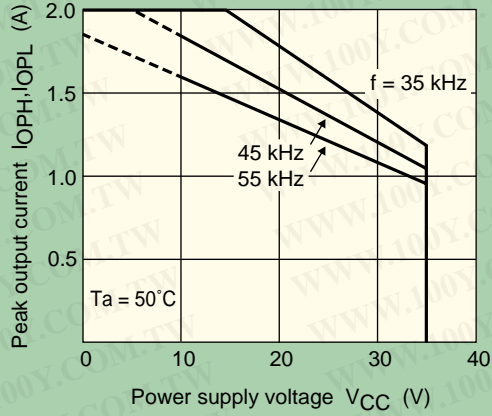

$I_{OPH}, I_{OPL} - V_{CC}$

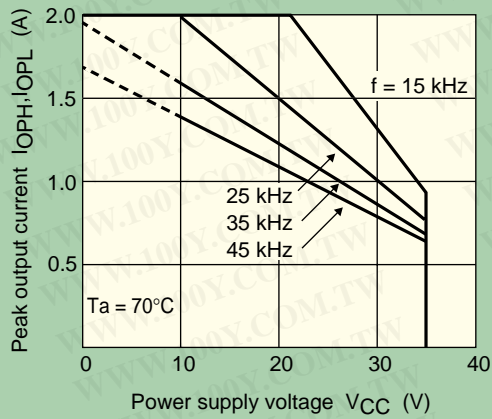

$I_{OPH}, I_{OPL} - V_{CC}$

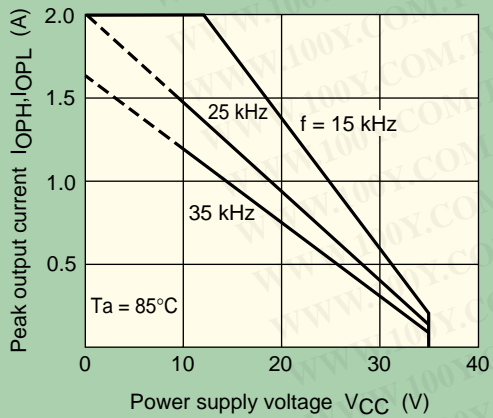

TLP250

$I_{OPH}, I_{OPL} - V_{CC}$

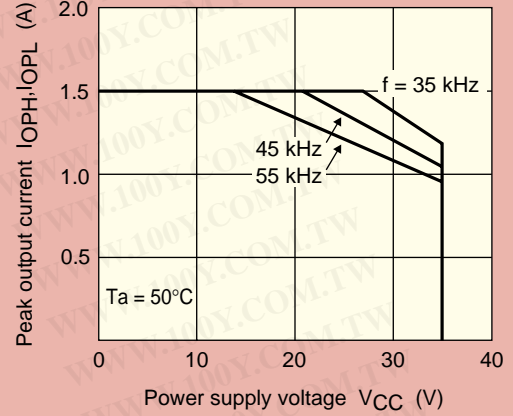

$I_{OPH}, I_{OPL} - V_{CC}$

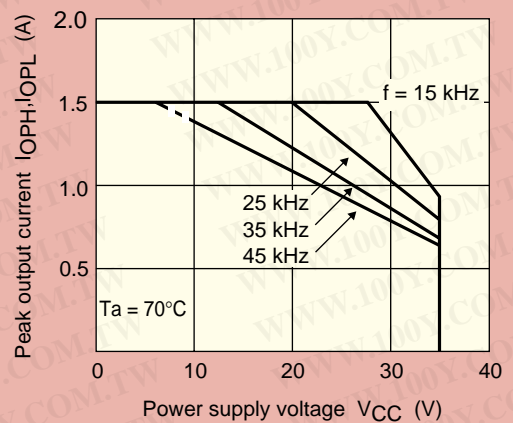

$I_{OPH}, I_{OPL} - V_{CC}$

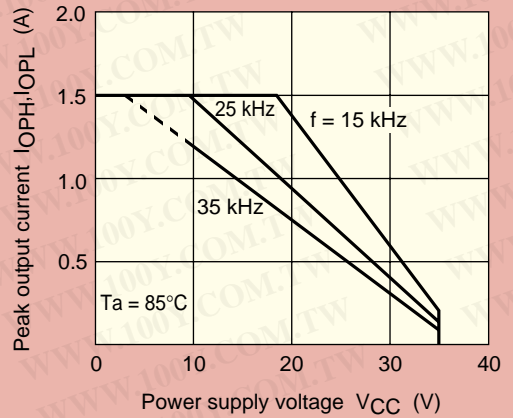

**Toshiba America
Electronic Components, Inc.****Headquarters-Irvine, CA**

9775 Toledo Way, Irvine,
CA 92618, U.S.A.
Tel: (949)455-2000 Fax: (949)859-3963

Altamonte Springs, FL(Orland)

600 S. North Lake Blvd., Suite 250,
Altamonte Springs, FL 32701, U.S.A.
Tel: (407)332-0966 Fax: (407)339-3777

Deerfield, IL(Chicago)

One Pkwy., North, Suite 500, Deerfield,
IL 60015-2547, U.S.A.
Tel: (847)945-1500 Fax: (847)945-1044

Denver, CO

8400 E. Prentice Englewood, CO 80111, U.S.A.
Tel: (303)220-9848 Fax: (303)220-9856

Edison, NJ

2035 Lincoln Hwy. Ste. #3000, Edison
NJ 08817, U.S.A.
Tel: (908)248-8070 Fax: (908)248-8030

Irvine, CA

2 Venture Plaza, Suite 500, Irvine,
CA 92718, U.S.A.
Tel: (714)453-0224 Fax: (714)453-0125

Microelectronics Center-Sunnyvale, CA

1220 Midas Way, Sunnyvale,
CA 94088-3509, U.S.A.
Tel: (408)739-0560 Fax: (408)746-0577

Norcross, GA(Atlanta)

655 Engineering Dr. #160, Norcross,
GA 30092, U.S.A.
Tel: (404)368-0203 Fax: (404)368-0075

Richardson, TX(Dallas)

777 East Campbell Rd., Suite 650, Richardson,
TX 75081, U.S.A.
Tel: (214)480-0470 Fax: (214)235-4114

Wakefield, MA(Boston)

401 Edgewater Place, Suite #360, Wakefield,
Essex, MA 01880-6229, U.S.A.
Tel: (617)224-0074 Fax: (617)224-1095

San Jose Engineering Center, CA

1060 Rincon Circle, San Jose,
CA 95131, U.S.A.
Tel: (408)456-8900 Fax: (408)456-8910

Toshiba Electronics Europe GmbH**Düsseldorf Head Office**

Hansaallee 181, D-40549 Düsseldorf
Germany
Tel: (0211)5296-0 Fax: (0211)5296-400

München Office

Büro München Hofmannstrasse 52,
D-81378, München, Germany
Tel: (089)748595-0 Fax: (089)748595-42

Toshiba Electronics France S.A.R.L.

Immeuble Robert Schumann 3 Rue de Rome,
F-93561, Rosny-Sous-Bois, Cedex, France
Tel: (1)48-12-48-12 Fax: (1)48-94-51-15

Toshiba Electronics Italiana S.R.L.

Centro Direzionale Colleoni
Palazzo Perseo Ingr. 2-Piano 6,
Via Paracelso n.12,
1-20041 Agrate Brianza Milan, Italy
Tel: (039)68701 Fax: (039)6870205

Toshiba Electronics España, S.A.

Parque Empresarial San Fernando Edificio Europa,
1ª Planta, ES-28831 Madrid, Spain
Tel: (91)660-6700 Fax: (91)660-6799

Toshiba Electronics(UK) Limited

Riverside Way, Camberley Surrey,
GU15 3YA, U.K.
Tel: (01276)69-4600 Fax: (01276)69-4800

Toshiba Electronics Scandinavia AB

Gustavslundsvägen 12, 2nd Floor
S-161 15 Bromma, Sweden
Tel: (08)704-0900 Fax: (08)80-8459

**Toshiba Electronics Asia
(Singapore) Pte. Ltd.**

Singapore Head Office
438B Alexandra Road, #06-08/12 Alexandra
Technopark, Singapore 119968
Tel: (278)5252 Fax: (271)5155, (270)6056

Bangkok Office

135 Moo 5 Bangkadi Industrial Park, Tivanon Rd.,
Bangkadi Amphur Muang Pathumthani 12000, Thailand
Tel: (2)501-1635 Fax: (2)501-1638

**Toshiba Electronics Trading
(Malaysia)Sdn. Bhd.**

Kuala Lumpur Head Office
Suite W1203, Wisma Consplant, No.2,
Jalan SS 16/4, Subang Jaya, 47500 Petaling Jaya,
Selangor Darul Ehsan, Malaysia
Tel: (3)731-6311 Fax: (3)731-6307

Penang Office

Suite 13-1, 13th Floor, Menard Penang Garden,
42-A, Jalan Sultan Ahmad Shah,
100 50 Penang, Malaysia
Tel: 4-226-8523 Fax: 4-226-8515

Toshiba Electronics Asia, Ltd.**Hong Kong Head Office**

Level 11, Top Glory Insurance Building,
Grand Century Place,
No.193, Prince Edward Road West,
Mong Kok, Kowloon, Hong Kong
Tel: 2375-6111 Fax: 2375-0969

Seoul Branch

14/F, KEC B/D, 257-7 Yangjae-dong,
Seocho-ku, Seoul, Korea
Tel: (02)589-4334 Fax: (02)589-4302

Seoul Branch, Gumi Office

6/F, Ssangyong Investment Securities B/D,
56 Songjung-Dong, Gumi City
Kyeongbuk, Korea
Tel: (0645)456-7613-6 Fax: (0546)456-7617

Beijing Office

Rm 714, Beijing Fortune Building,
No.5 Dong San Huan Bei-Lu, Chao Yang District,
Beijing, 100004, China
Tel: (010)6590-8795 Fax: (010)6590-8791

Chengdu Office

Unit F, 18/F, 42 Wenwu Road
Xinhua Avenue, Chengdu, 610017, China
Tel: (028)675-1773 Fax: (028)675-1065

Shenzhen Office

Rm 3010-3012, Office Tower Shun Hing Square,
Di Wang Commercial Centre, 333 ShenNan
East Road, Shenzhen, 518008, China
Tel: (0755)246-1582 Fax: (0755)246-1581

**Toshiba Technology Development
(Shanghai) Co., Ltd.**

23F, Shanghai Senmao International Building, 101
Yin Cheng East Road, Pudong New Area, Shanghai,
200120, China
Tel: (021)6841-0666 Fax: (021)6841-5002

Tsurong Xiamen Xiangyu Trading Co., Ltd.

8N, Xiamen SEZ Bonded Goods Market Building,
Xiamen, Fujian, 361006, China
Tel: (0592)562-3798 Fax: (0592)562-3799

**Toshiba Electronics
Taiwan Corporation****Taipei Head Office**

17F, Union Enterprise Plaza Bldg. 109
Min Sheng East Rd., Section 3, 0446 Taipei,
Taiwan
Tel: (02)514-9988 Fax: (02)514-7892

Kaohsiung Office

16F-A, Chung-Cheng Bldg., Chung-Cheng 3Rd.,
80027, Kaohsiung, Taiwan
Tel: (07)222-0826 Fax: (07)223-0046

**Toshiba Display Devices
(Thailand) Co., Ltd.**

142 Moo 5, Bangkadi Industrial Park,
Tivanon Rd., Pathumthani 12000, Thailand
Tel: (2)501-1200 Fax: (2)501-1209

勝特力材料 886-3-5753170
勝特力电子(上海) 86-21-54151736
勝特力电子(深圳) 86-755-83298787
[Http://www.100y.com.tw](http://www.100y.com.tw)

The information contained herein is subject to change without notice.

The information contained herein is presented only as a guide for the applications of our products. No responsibility is assumed by TOSHIBA for any infringements of patents or other rights of the third parties which may result from its use. No license is granted by implication or otherwise under any patent or patent rights of TOSHIBA or others.

TOSHIBA is continually working to improve the quality and the reliability of its products. Nevertheless, semiconductor devices in general can malfunction or fail due to their inherent electrical sensitivity and vulnerability to physical stress. It is the responsibility of the buyer, when utilizing TOSHIBA products, to observe standards of safety, and to avoid situations in which a malfunction or failure of a TOSHIBA product could cause loss of human life, bodily injury or damage to property. In developing your designs, please ensure that TOSHIBA products are used within specified operating ranges as set forth in the most recent products specifications. Also, please keep in mind the precautions and conditions set forth in the TOSHIBA Semiconductor Reliability Handbook.

Gallium arsenide (GaAs) is a substance used in some of the products described in this documents. GaAs dust and fumes are toxic. Do not break, cut or pulverize the products, or use chemicals to dissolve them. When disposing of the products, follow the appropriate regulations. Do not dispose of the products with other industrial waste or with domestic garbage.

Website: <http://doc.semicon.toshiba.co.jp/indexus.htm>

In Touch with Tomorrow
TOSHIBA

TOSHIBA CORPORATION

Electronic Devices Sales & Marketing Group
1-1, Shibaura 1-chome, Minato-ku, Tokyo, 105-8001, Japan
Tel: (03)3457-3405 Fax: (03)5444-9324