



TR94

80 Amp. High Current Automotive Relay

MAIN FEATURES

- Plug-in terminals, easy to handle worldwide changeable, with ISO socket.
- Small size, high capacity, rated load 80A.
- Usage of relay in car
- Compressor Light Starter Horn

APPLICATIONS

- For direct connection with Cell Motors, Transmission, etc. and Anti-Locking Brake System.

ORDERING INFORMATION



Option Socket :
Please refer appendix P107



- OD07-0015A
- OD07-0016A

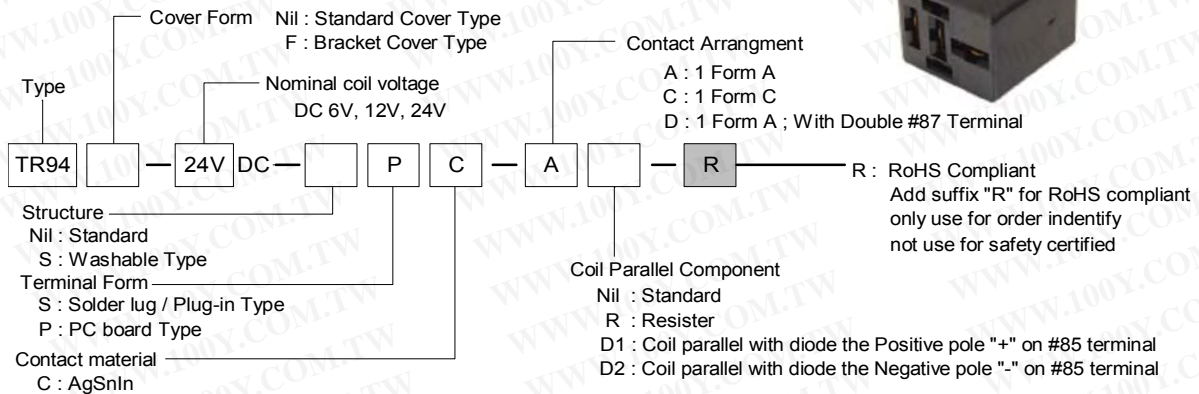

DIMENSION (unit:mm) DRILLING (unit:mm) WIRING DIAGRAM

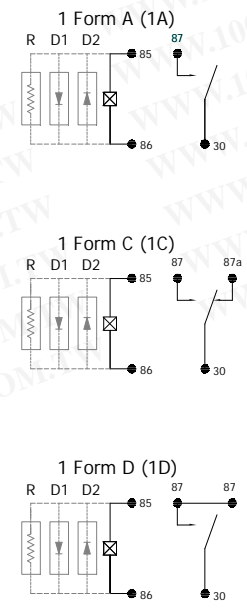
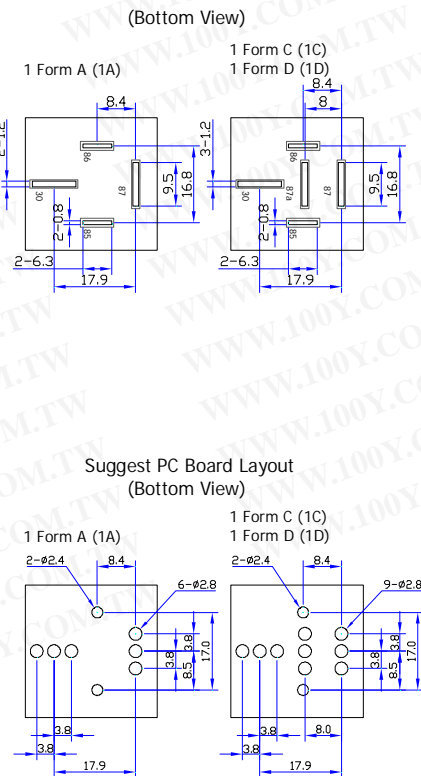
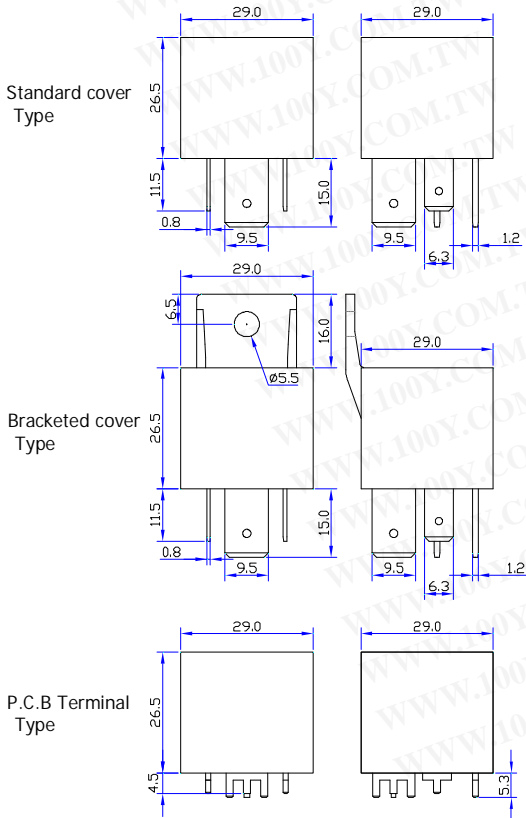

* Coil Parallel Component Option

勝特力材料 886-3-5753170
 勝特力电子(上海) 86-21-34970699
 勝特力电子(深圳) 86-755-83298787
[Http://www.100y.com.tw](http://www.100y.com.tw)

➤ COIL DATA CHART(at 20°C)

Coil Sensitivity	Coil Voltage Code	Nominal Voltage (VDC)	Nominal Current (mA)	Coil Resistance (Ω) $\pm 10\%$	Power Consumption (W)	Pull-In Voltage (VDC)	Drop-Out Voltage (VDC)	Max-Allowable Voltage (VDC)
TR94	6	6	300	20	abt. 1.8	75% Max.	5% Min.	130% but for short time carrying current
	12	12	150	80				
	24	24	75	320				

➤ CONTACT RATING

Item	Type	TR94		
		1 Form A	1 Form C	1 Form D
Contact Rating		80A 14VDC	N.O. : 80A 14VDC N.C. : 60A 14VDC	2 x 25A/14VDC
Max. Carrying Current		80A		
Max. Make Current		120A		
Max. Break Current		80A		
Max. Switching Voltage		75VDC		
Max. Switching Power		70 ~ 500Watts DC		
Contact Material		Ag Alloy		

➤ PERFORMANCE (at initial value)

Item	Type	TR94
Contact Resistance		100m Ω Max.
Operation Time		10msec Max.
Release Time		10msec Max. (type with diode inside : 20msec max.)
Dielectric Strength	Between coil & contact Between contacts	500VAC 50/60Hz (1 minute) 500VAC 50/60Hz (1 minute)
Insulation Resistance		100 M Ω Min. (500VDC)
Max. ON/OFF Switching	Mechanically Electrically	300 operation/min 30 operation/min
Operating Ambient Temperature		-30°C to +80°C (No water drop condensation)
Operating Humidity		80% (at 40°C) RH
Coil Temperature Rise		60 deg. Max. (at rated coil voltage)
Vibration	Endurance Error Operation	10 to 55Hz Double Amplitude 1.5mm 10 to 55Hz Double Amplitude 1.5mm
Shock	Endurance Error Operation	100G Min. 10G Min.
Life Expectancy	Mechanically Electrically	1×10^7 ops. 1×10^5 ops.
Weight		abt. 45grs.

➤ REFERENCE DATA

1. Maximum value for switching capacity
No. of operations : 10^5

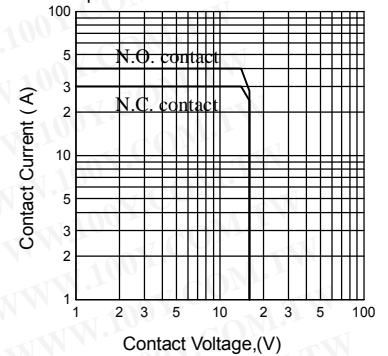

2-(1). Coil temperature rise (resistive)
Ambient temperature: 20°C, 85°C, 125°C;
68°F, 185°F, 257°F

Contact carrying current : 70A
Coil applied voltage : 12V, 14V, 16V DC

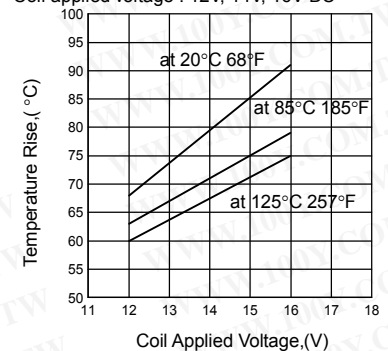

2-(1). Coil temperature rise (resistive)
Ambient temperature : 20°C, 68°C
Contact carrying current : 50A, 60A, 70A, 80A
Coil applied voltage : 12V, 14V, 16V DC

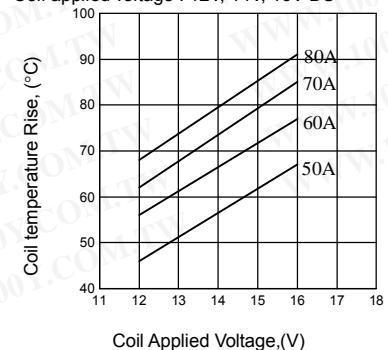

勝特力材料 886-3-5753170
勝特力电子(上海) 86-21-34970699
勝特力电子(深圳) 86-755-83298787
[Http://www.100y.com.tw](http://www.100y.com.tw)