

# TS2-系列 $\Phi 22/\Phi 25$

## ■ 照光按鈕裝配尺寸



## ■ 直接式照光按鈕接點圖

型 式	TN2-A	TN2-B
接 點	1a	1b
接點圖		

## ■ 型號說明

	<div style="display: flex; justify-content: space-around; align-items: center;"> <div style="border: 1px solid black; padding: 2px 5px;">TS2</div> <div style="border: 1px solid black; padding: 2px 5px;">IF</div> <div style="border: 1px solid black; padding: 2px 5px;">1</div> <div style="border: 1px solid black; padding: 2px 5px;">R</div> <div style="border: 1px solid black; padding: 2px 5px;">-</div> <div style="border: 1px solid black; padding: 2px 5px;">I</div> <div style="border: 1px solid black; padding: 2px 5px;">A</div> </div> <div style="display: flex; justify-content: space-around; align-items: center; margin-top: 10px;"> <div style="border: 1px solid black; border-radius: 50%; width: 20px; height: 20px; display: flex; align-items: center; justify-content: center;">①</div> <div style="border: 1px solid black; border-radius: 50%; width: 20px; height: 20px; display: flex; align-items: center; justify-content: center;">②</div> <div style="border: 1px solid black; border-radius: 50%; width: 20px; height: 20px; display: flex; align-items: center; justify-content: center;">③</div> <div style="border: 1px solid black; border-radius: 50%; width: 20px; height: 20px; display: flex; align-items: center; justify-content: center;">④</div> <div style="border: 1px solid black; border-radius: 50%; width: 20px; height: 20px; display: flex; align-items: center; justify-content: center;">⑤</div> <div style="border: 1px solid black; border-radius: 50%; width: 20px; height: 20px; display: flex; align-items: center; justify-content: center;">⑥</div> </div>	
項次	代號	說明
1.固定孔徑	TS2	$\Phi 22\text{mm}/\Phi 25\text{mm}$
2.型 式	IF IL IM	平頭 凸頭 大頭
3.電 壓	1 2 5 6 7 8 9	110VAC LED 燈泡 220VAC LED 燈泡 6VAC/DC 鎢絲、LED 燈泡 18VAC/DC 鎢絲燈泡 24VAC/DC 鎢絲燈泡、LED 燈泡 30VAC/DC 鎢絲燈泡 12VAC/DC 鎢絲燈泡、LED 燈泡
4.顏 色	R G O W BL	紅 綠 橙 白 藍
5.燈泡種類	I	鎢絲燈泡

	L	LED 燈泡
6.接點種類	A	1a
	B	1b

### 燈泡外觀尺寸



### 裝配孔徑與距離(Φ22/Φ25 系列)

尺寸說明：所有尺寸均為 30mm

勝特力材料 886-3-5753170  
 勝特力电子(上海) 86-21-54151736  
 勝特力电子(深圳) 86-755-83298787  
[Http://www.100y.com.tw](http://www.100y.com.tw)

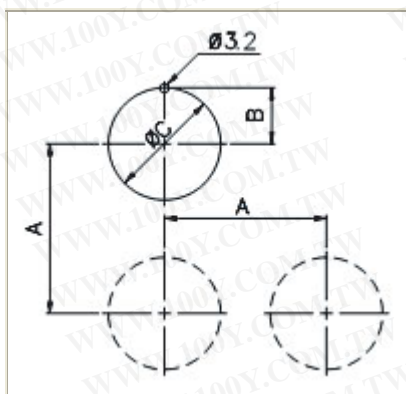

系 列		Φ22	Φ25
A	指示燈.按鈕.選擇.		31min.
	大頭		39min.
B	所有機種	11.2	12.7
C	所有機種	22.4	25.4

### 接點額定值

交 流	AC11	AC24V	AC110V	AC220V	AC380V	AC440V
	電感負載	7.5A	4.5A	3A	2A	2A
	電阻負載	7.5A	7.5A	4.5A	4A	4A

直 流	DC11	DC24V	DC110V	DC220V	DC380V
	電感負載	1.5A	0.5A	0.2A	0.1A
	DC14	DC24V	DC220V	DC220V	DC380V
	電阻負載	10A	2A	0.6A	0.2A

■ 特性

動作頻率	機 械	複歸式按鈕為 60 次/分,其餘為 30 次/分
	電 氣	30 次/分
壽 命	機 械	複歸式按鈕為 3,000,000 次,其餘為 300,000 次
	電 氣	複歸式按鈕為 500,000 次,其餘為 200,000
沖 擊	耐 久	1000m/s <sup>2</sup>
	誤動作	非照光式複歸按鈕為 1000m/s <sup>2</sup> ,其餘為 250m/s <sup>2</sup>
振 動	誤動作	10~55Hz
接觸電阻	50mΩ 以下(初期值)	
絕緣電阻	500VDC 電壓下, 100MΩ 以上	
耐 電 壓	AC2500V 之電壓測試一分鐘, 無短路, 破壞, 燒毀等異常現象	
周圍溫度	-20°C ~ +60°C	
周圍濕度	45~85%RH	

勝特力材料 886-3-5753170  
 勝特力电子(上海) 86-21-54151736  
 勝特力电子(深圳) 86-755-83298787  
[Http://www.100y.com.tw](http://www.100y.com.tw)

■ 接點圖.

型式	TS2-A	TS2-B	TS2-C	TS2-A	TS2-2B
接點	1a	1b	1a1b	2a	2b
接點圖					

■ 燈泡種類與規格(含照光式與指示燈) 燈座全部為 BA9S-11x28mm(9), 最大功率 1.2W

燈光種類	代號	額定電壓	代號	操作電壓	額定電流	顏色	代號	型號編排
鎢絲燈泡	I	6VAC/DC	6	6VAC/DC	150mA	無	空白	
		12VAC/DC	12	12VAC/DC	100mA			
		18VAC/DC	18	18VAC/DC	66mA			
		24VAC/DC	24	24VAC/DC	50mA			
		30VAC/DC	30	30VAC/DC	40mA			
LED 燈泡	L	6VAC/DC	6	6VAC/DC	9~13mA	綠 藍	R BL	
		12VAC/DC	12	12VAC/DC	9~13mA	綠 白	G W	
		24VAC/DC	24	24VAC/DC	8~13mA			
		110VAC	110	110VAC	3~5mA			
		220VAC	220	220VAC	3~5mA			

# T2-系列 $\Phi 22/\Phi 25/\Phi 30$

## 直接式照光按鈕上座裝配尺寸

T2IFR



T2IMR



T2IAR



T2IBR



T2IFS



T2IKR



T2ITL



T2ILS



T2IMS



T2IAS



T2IBS



T2IKS



## 燈泡種類與規格(含照光式與指示燈) 燈座全部為 BA9S-11x28mm(9), 最大功率 1.2W

● 鎢絲燈泡

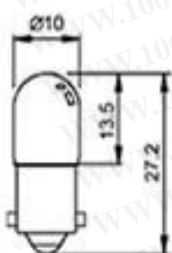

● 霓虹燈泡

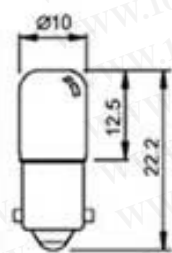

● LED 燈泡

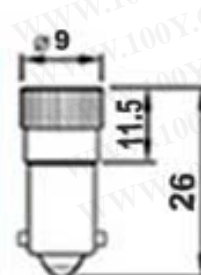

勝特力材料 886-3-5753170  
 勝特力电子(上海) 86-21-54151736  
 勝特力电子(深圳) 86-755-83298787  
[Http://www.100y.com.tw](http://www.100y.com.tw)

燈泡種類	代號	額定電壓	代號	操作電壓	額定電流	顏色	代號	型號編排
鎢絲燈泡	I	6VAC/DC	6	6VAC/DC	150mA	無	空白	
		12VAC/DC	12	12VAC/DC	100mA			
		18VAC/DC	18	12VAC/DC	66mA			
		24VAC/DC	24	24VAC/DC	50mA			
		30VAC/DC	30	30VAC/DC	40mA			
LED 燈泡	L	6VAC/DC	6	6VAC/DC	9~13mA	紅 藍 綠 白 橙 黃綠	R BL G W O YG	
		24VAC/DC	24	24VAC/DC	8~13mA			
		30VAC/DC	30	30VAC/DC	8~13mA			
		110VAC	110	110VAC	3~5mA			
		220VAC	220	220VAC	3~5mA			
霓虹燈泡	N	110VAC	110	110VAC	1.3mA	紅 綠 藍	R G BL	
		220VAC	220	220VAC	2.2mA			
		380VAC	380	380VAC	1.15mA			

### 型號說明

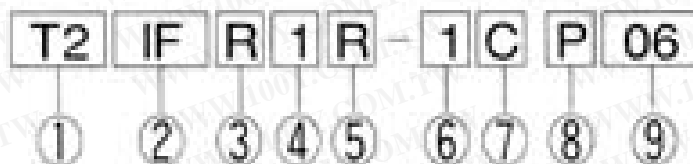

勝特力材料 886-3-5753170  
 勝特力电子(上海) 86-21-54151736  
 勝特力电子(深圳) 86-755-83298787  
[Http://www.100y.com.tw](http://www.100y.com.tw)

項次	Signal	Description
1.固定孔徑	T2	Φ 22mm/ Φ 25mm
	T3	Φ 30mm
2.型式	IF	平頭
	IL	凸頭
	IM	大頭
	IA	凸頭交替式
	IB	大頭交替式
	IK	連鎖式
	IT	二點式
3.外型	R	圓型
	S	方型
	L	長方型
4.電壓	1	110VAC (霓虹燈泡)
	2	220 “ (霓虹燈泡)
	3	380 “ (霓虹燈泡)
	4	440 “ (霓虹燈泡)
	5	6V “ (鎢絲燈泡/LED)
	6	18V “ (鎢絲燈泡/LED)
	7	24V “ (鎢絲燈泡/LED)

	8	30V “(鎢絲燈泡/LED)
	9	12V “(鎢絲燈泡/LED)
5.顏色	R	紅
	G	綠
	O	橙
	W	白
	BL	藍
6.接點數目	1	1組
	2	2組
	3	3組
7.接點種類	A	1a
	B	1b
	C	1a1b
8.刻字	空白	無刻字
	P	英文刻字
	M	中文刻字

註：1.方型系列固定孔徑只有 $\Phi 22\text{mm}/\Phi 25\text{mm}$ 二種。

2.二點式照光按鈕為長方型。

**勝特力材料 886-3-5753170**  
**勝特力电子(上海) 86-21-54151736**  
**勝特力电子(深圳) 86-755-83298787**  
[Http://www.100y.com.tw](http://www.100y.com.tw)

# TN2 系列 $\Phi 22/\Phi 25/\Phi 30$

## ■ 外觀尺寸

本系列開關接點座為標準接點座，其接點形式、接點圖、裝配尺寸見 G3、4 頁。

TN2BF



TN3BF



TN2BL



TN3BL



TN2BM

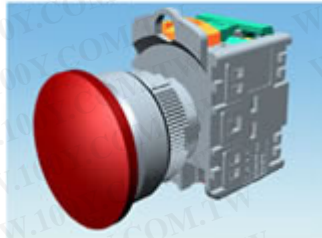

TN3BM



TN2BK



TN3BK



TN2BP



TN3BP

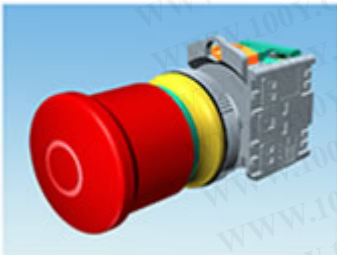

TN2BT



TN3BT



TN2BA

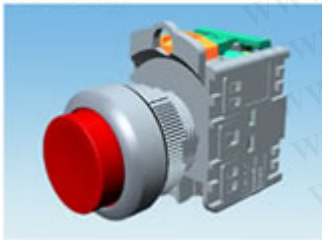

TN3BA



勝特力材料 886-3-5753170  
勝特力电子(上海) 86-21-54151736  
勝特力电子(深圳) 86-755-83298787  
[Http://www.100y.com.tw](http://www.100y.com.tw)

■ 型號說明 (注：按鈕如需印字，鈕的顏色皆為清澈透明，紅、黃、綠等顏色在護蓋上顯示。)

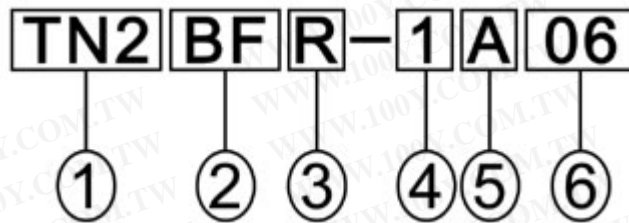

勝特力材料 886-3-5753170  
 勝特力电子(上海) 86-21-54151736  
 勝特力电子(深圳) 86-755-83298787  
[Http://www.100y.com.tw](http://www.100y.com.tw)

如下圖：



項次	代號	說明
1.固定孔徑	TN2	Ø22mm/Ø25mm
	TN3	Ø30mm
2.型式	BF	平頭
	BL	凸頭
	BM	大頭
	BA	凸頭交替式
	BK	連鎖式
	BP	按拉式
	BT	二點式
3.顏色	R	紅
	G	綠
	Y	黃
	W	白
	B	黑
4.接點數目	1	1 組
	2	2 組
	3	3 組
	4	4 組
5.接點種類	A	1a
	B	1b
	C	1a1b
	AB	1a+1b



6.刻字種類	01~41	詳見 G20
--------	-------	--------

■ 燈泡外觀尺寸

燈泡種類與規格(含照光式與指示燈) 燈泡全部為 BA9S-11x28mm(Ø9), 最大功率 1.2W



燈泡種類	代號	額定電壓	代號	操作電壓	額定電流	顏色	代號	型號編排
鎢絲燈泡	I	6VAC/DC	6	6VAC/DC	150mA	無	空白	
		12VAC/DC	12	12VAC/DC	100mA			
		18VAC/DC	18	12VAC/DC	66mA			
		24VAC/DC	24	24VAC/DC	50mA			
		30VAC/DC	30	30VAC/DC	40mA			
LED 燈泡	L	6VAC/DC	6	6VAC/DC	9~13mA	紅 藍 綠 白 橙 黃綠	R BL G W O YG	
		24VAC/DC	24	24VAC/DC	8~13mA			
		30VAC/DC	30	30VAC/DC	8~13mA			
		110VAC	110	110VAC	3~5mA			
		220VAC	220	220VAC	3~5mA			
霓虹燈泡	N	110VAC	110	110VAC	1.3mA	紅 綠 藍	R G BL	
		220VAC	220	220VAC	2.2mA			
		380VAC	380	380VAC	1.15mA			
		440VAC	440	440VAC	1.4mA			

勝特力材料 886-3-5753170  
 勝特力电子(上海) 86-21-54151736  
 勝特力电子(深圳) 86-755-83298787  
[Http://www.100y.com.tw](http://www.100y.com.tw)