

TS6601T

TS66 Series Tact Switch

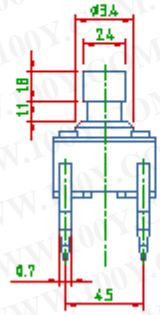

CIRCUIT DIAGRAM

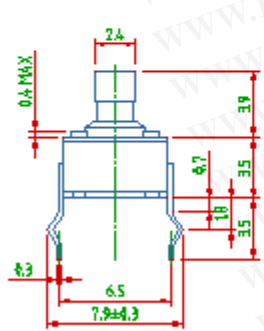
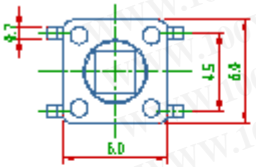
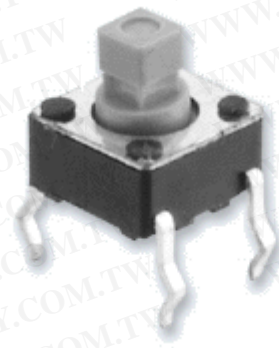
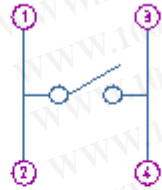

P.C.B LAYOUT

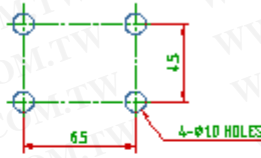

1. Rating : DC 12V, 50mA
2. Travel : 0.25±0.1m/m
3. Operating Force : 130 or 160 ±30gf
or 250 ±50gf
4. Contact Resistance : 50m Ω MAX
5. Life : 100,000 Cycles Min

ITEM	DESCRIPTION	Q'TY	MATERIALS	TREATMENT	REMARK
1	BASE	1	NYLON 46 GBM%	UL 94	
2	COVER	1	SPCC	Ni plating	
3	STEM	1	NYLON 46 GBM%	UL 94	
4	TERMINAL	1	BRASS T=1.2	Ag plating	
5	CONTACTOR	1	CS210P-DH T=1.35	Ag plating	

勝特力材料 886-3-5753170
 勝特力电子(上海) 86-21-54151736
 勝特力电子(深圳) 86-755-83298787
[Http://www.100y.com.tw](http://www.100y.com.tw)

TACTILE SWITCH SPECIFICATION

TS6601Series

1. General

1.1 Test condition :The standard test shall be 5 ~ 35deg C temperature and 45 ~ 85℃ Relative humidity 860 ~ 1060 Hpa atmospheric pressure unless otherwise specified. In case of any question happen.

retest condition shall specify by temperature 20 +/- 2deg C, 65 +/- 5℃ RH. and 860 ~ 1060 Hpa.

1.2 Operation temperature range; 5deg C ~ 70deg C.
 storage temperature range; -30deg C ~ 80deg C.

2. Rating; On switching rating DC 12V, 50mA.

3. Electrical Characteristic; G

	Item	Test Condition	Specification
3.1	Contact resistance	to be measure with AC 1 K Hz+/- 200 Hz. ; Max 20mV, Max 50mA; or 10mA, 5V DC. Applying a static load twice the operation force to the Center of the stem	Max 50 mOhm
3.2	Insulation resistance	To be measured with an insulation measuring device of 500V DC between all the terminals and between the terminals and the frame for 1 minute +/- 5 seconds.	Min 100 MOhm
3.3	Dielectric breakdown voltage	AC 250V 50 - 60Hz, 2mA current; being applied between all the adjacent terminals and between the terminal and frame for 1 minute.	No breakdown insulation
3.4	Switch capacitance	To measured with frequency 1 MHz +/-10 KHz applied between adjacent terminal and circuit.	Max 5PF
3.5	Bounce	Lightly striking the center of the stem at a rate Encountered in normal use (3 to 4 operations per sec) Bounce shall be tested at " on" and "off".	10m sec Max

4. Mechanical characteristic

	Item	Test conditions	Specification
4.1	Operating force	Placing the switch such that the direction of switch operation is vertical and then gradually increasing the load applied to the center of stem, the maximum load required for the stem to come to a stop shall be measured.	; 1/30 +/- 30 gf ; 1/460 +/- 30 gf ; 1/250 +/- 50 gf ; 1/others specified _____
4.2	Stop strength	Measurement is made with a static load applied to the foot of the control unit in the operating vertical direction. A static force of 3K gf being applied in one direction on the tip of the terminal for 1 minute. One time each terminal.	No bending or deflection experienced. The terminal may be bent, but shall not break or damage the insulation material.
4.3	Travelling stroke	Placing the switch such that the direction of switch operation is vertical and then applying a static load twice the operating force to the center of stem, the travel distance for the stem to come to a stop shall be measured.	0.25+0.1/-0.1 mm
4.4	Return Force	The sample switch is installed such that the direction of switch operation is vertical and, upon depression of the stem in its center the whole travel distance, the force of the stem to Return to its free position shall be measured.	50 gf Min
4.5	Vibration test	The range of vibration; 10 ~ 55 Hz Total width of vibration; 4.5 mm	Contact resistance (3.1; Max 50 mOhm Insulation resistance (3.2; Min 100 MOhm

		The proportion of vibration; G $10 \sim 55 \sim 10$; f ; approx. 1 minute The variation of the number of vibration; G Logarithmic or approximately straight line The directions; G vertical directions including operation direction Duration; Q hours each ; total 6 hours; b	Dielectric breakdown voltage (3.3; AC 250 V 1 minute no breakdown insulation Operating force; f .1; meet original spec. travelling stroke $0.25+0.1/-0.1$ mm As per individual specifications No apparent effect on physical appearance or mechanical functions
4.6	Impact shock	Measurements shall be made following the test set forth below: (1).Acceleration:50G (2).Action time:11 +/- 1 m sec (3).Cycles of test: 3 cycles each in 6 directions, for a total of 18 cycle.	
4.7	Solder ability	Soldering temperature; $Q30 \pm 5$ deg C Immersing time; $G \pm 0.5$ sec FLUX 5~ 10 SEC.	More than 70% of the part immersed can be covered with solder.
4.8	Soldering temperature	P.C board terminal at 245 ± 5 deg C, 10 ~ 15 second or 350deg CMAX 3 sec.	No defect in appearance shall be observed but the electrical characteristic; f ; shall be maintained.

5. Reliability

	Item	Test conditions	Specification
5.1	Cold resistance	Switch for testing being kept in the conditions at -30 ± 2 deg C in temperature for 96 hours, and in a normal ambient condition for one hour, then to be measured within one hour. ; Drops of water being taken away; ^	Contact resistance ; f .1; Max 50 mOhm Insulation resistance(3.2; ^ Min 100 MOhm Dielectric breakdown voltage: AC 250 V 1 minute no breakdown insulation Operating force; f .1; meet original spec.
5.2	Dry heat resistance	Switch for testing being kept in the conditions at 70 ± 2 deg C in temperature for 96 hours, and in a normal ambient condition for one hour, then to be measured within one hour.	There shall be no defects in appearance or in the mechanical functions
5.3	Resistance to humidity	Switch for testing being kept in the conditions at 40 ± 2 deg C in temperature and $90 \sim 95$ °C HRH for 96hours, and in a normal ambient condition for one hour, then measured within one hour.	Contact resistance ; f .1; Max 200 mOhm Insulation resistance(3.2; ^ Min 10 MOhm Dielectric breakdown voltage: AC250 V 1 minute no breakdown insulation Operating force; f .1; meet original spec. There shall be no defects in appearance or in the mechanical functions
5.4	Salt-spray test	The sample is allowed to stand in the test chamber controlled to 35 ± 2 deg C in temperature and 5 ± 1 °C f weight ratio ; Salt- water concentration for 24 ± 1 hours and is subjected to test. Then, salt deposits attached to the sample are washed away with water.	Shall be free from functionally harmful rust.
5.5	Temperature cycle test	After 5 cycle testing under the following conditions, the sample is allowed to stand under normal temperature and humidity conditions for 1 hour,	Contact resistance ; f .1; Max 50 mOhm Insulation resistance(3.2; ^ Min 100 MOhm Dielectric breakdown voltage: AC 250 V

勝特力材料 886-3-5753170
 勝特力电子(上海) 86-21-54151736
 勝特力电子(深圳) 86-755-83298787
[Http://www.100y.com.tw](http://www.100y.com.tw)

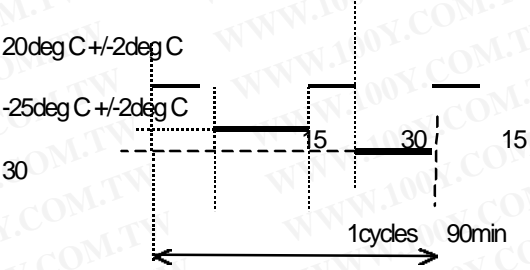
	<p>and measurement is made within 1 hour after that. Water drops should be eliminated. 70deg C +/-2deg C</p> 	<p>Dielectric breakdown voltage: AC 250 V 1 minute no breakdown insulation Operating force; 4.1; meet original spec There shall be no defects in appearance or in the mechanical functions</p>
--	--	--

6. Durability

	Item	Test conditions	Specification
6.1	Operation life	<p>Measurements shall be made following the test set forth below:</p> <ol style="list-style-type: none"> (1).DC 12V 50mA resistive load (2) Rate of operation: 2 to 3 operations per second (3). Depression: Twice the operation force (4) Cycle of operation: <ul style="list-style-type: none"> i ¼ 50,000 cycle i ¼ 100,000 cycle i ¼ 500,000 cycle i ¼ 1,000,000 cycle 	<p>Contact resistance:500 m ohm Max Insulation resistance:10 M ohm Min Bounce 10 m sec Max operation force :initial force +/-30% Item 3.3,4.3:original spec.</p>