

UG10ACT THRU UG10DCT

ULTRAFAST SOFT RECOVERY RECTIFIER

Reverse Voltage - 200 Volts

Forward Current - 10.0 Amperes

TO-220AB

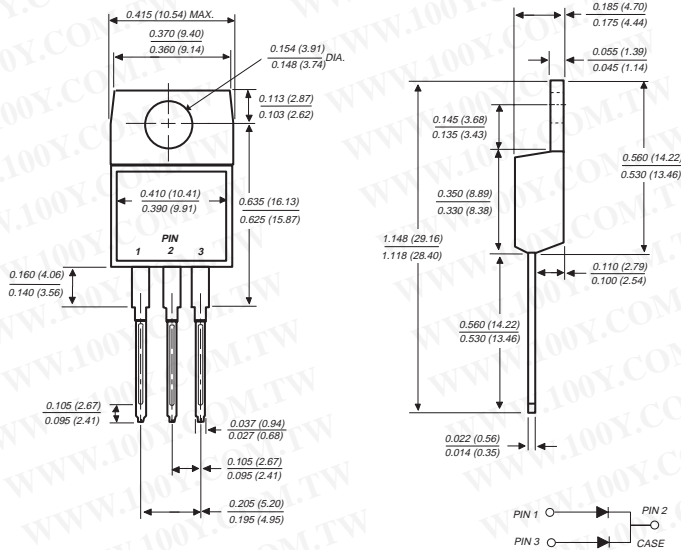

FEATURES

- ◆ Plastic package has Underwriters Laboratories Flammability Classification 94V-0
- ◆ Ideally suited for free wheeling diode power factor correction applications
- ◆ Soft recovery characteristics
- ◆ Excellent high temperature switching
- ◆ Optimized to reduce switching losses
- ◆ High temperature soldering guaranteed: 250°C/10 seconds at terminals
- ◆ Glass passivated chip junction

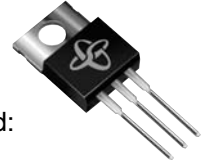

MECHANICAL DATA

Case: JEDEC TO-220AB molded plastic body

Terminals: Plated leads, solderable per MIL-STD-750, Method 2026

Polarity: As marked

Mounting Position: Any

Mounting Torque: 5 in. - lbs. max.

Weight: 0.08 ounce, 2.24 grams

MAXIMUM RATINGS AND ELECTRICAL CHARACTERISTICS

Ratings at 25°C ambient temperature unless otherwise specified.

	SYMBOLS	UG10ACT	UG10BCT	UG10CCT	UG10DCT	UNITS
Maximum repetitive peak reverse voltage	V _{RRM}	50	100	150	200	Volts
Working peak reverse voltage	V _{RWM}	50	100	150	200	Volts
Maximum RMS voltage	V _{RMS}	35	70	105	140	Volts
Maximum DC blocking voltage	V _{DC}	50	100	150	200	Volts
Maximum average forward rectified current at T _C =100°C	I _(AV)	10				Amps
Peak forward surge current 8.3ms single half sine-wave superimposed on rated load (JEDEC Method) per leg	I _{FSM}	60				Amps
Maximum instantaneous forward voltage per leg at I _F =10A, T _J =25°C I _F =5A, T _J =25°C I _F =5A, T _J =150°C	V _F	1.25 1.10 0.895				Volts
Maximum reverse leakage current per leg at working peak reverse voltage	I _R	10 200				μA
Maximum reverse recovery time per leg at I _F =1.0A, di/dt=100A/μs, V _R =30V, I _{rr} =0.1 I _{RM}	t _{rr}	25				ns
Maximum reverse recovery time per leg at I _F =0.5A, I _R =1.0A, I _{rr} =0.25A	t _{rr}	25 15				ns
Maximum reverse recovery current per leg at I _F =5A, di/dt=50A/μs, V _R =30V	I _{RM}	0.7				Amps
Maximum stored charge per leg I _F =2A, di/dt=20A/μs, V _R =30V I _{rr} =0.1 I _{RM}	Q _{rr}	5.5 4.5				nC
Typical thermal resistance from junction to case per leg	R _{θJC}	4.5				°C/W
Operating junction and storage temperature range	T _J , T _{STG}	-40 to +150				°C

NOTICE: Advanced product information is subject to change without notice

勝特力材料 886-3-5753170
 勝特力电子(上海) 86-21-54151736
 勝特力电子(深圳) 86-755-83298787
[Http://www.100y.com.tw](http://www.100y.com.tw)

 **GENERAL
SEMICONDUCTOR®**

RATINGS AND CHARACTERISTIC CURVES UG10ACT THRU UG10DCT

FIG. 1 - FORWARD CURRENT DERATING CURVE

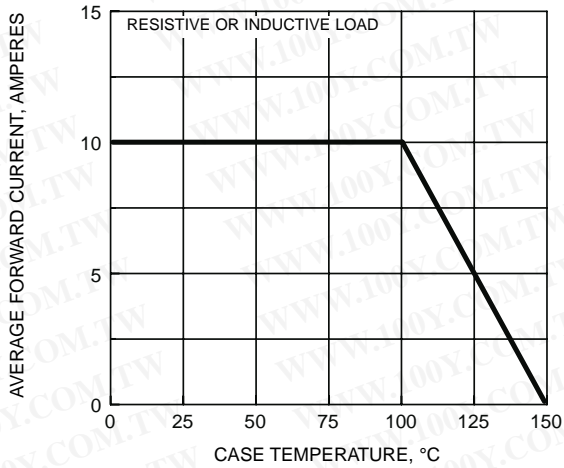

FIG. 2 - MAXIMUM NON-REPETITIVE PEAK FORWARD SURGE CURRENT PER LEG

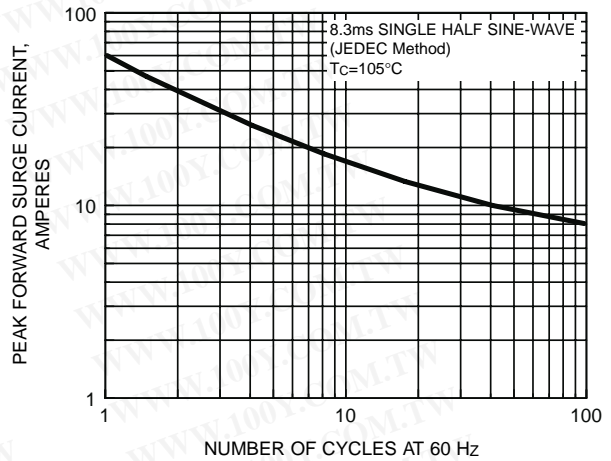

FIG. 3 - TYPICAL INSTANTANEOUS FORWARD CHARACTERISTICS PER LEG

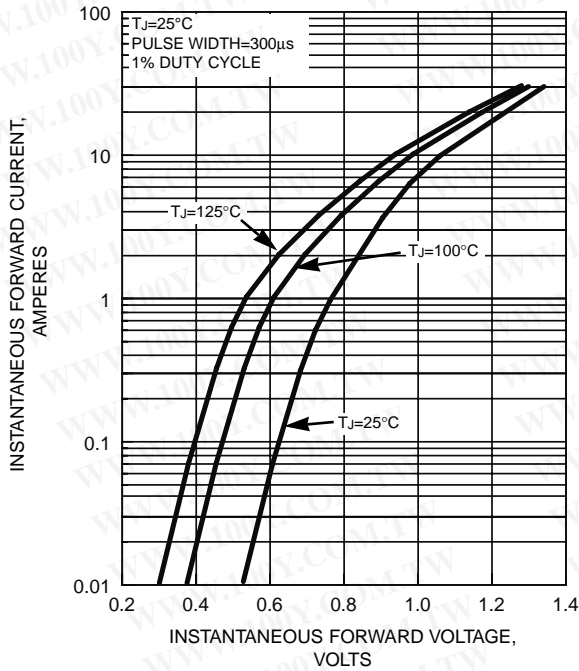

FIG. 4 - TYPICAL REVERSE CHARACTERISTICS PER LEG

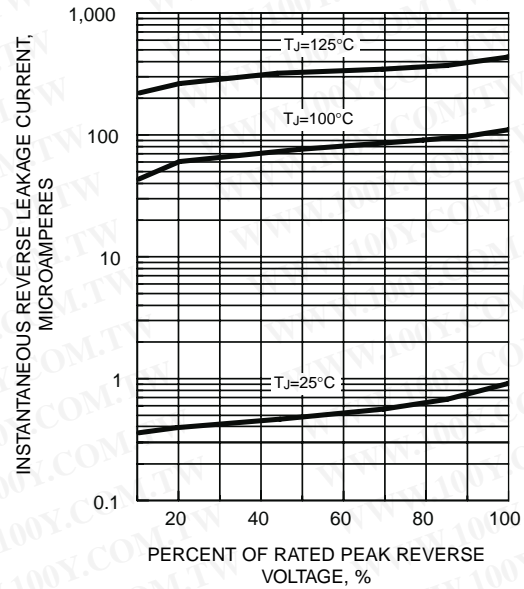

FIG. 5 - REVERSE SWITCHING CHARACTERISTICS PER LEG

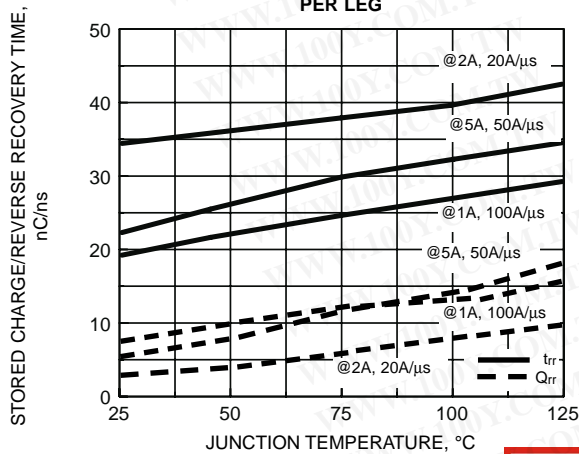
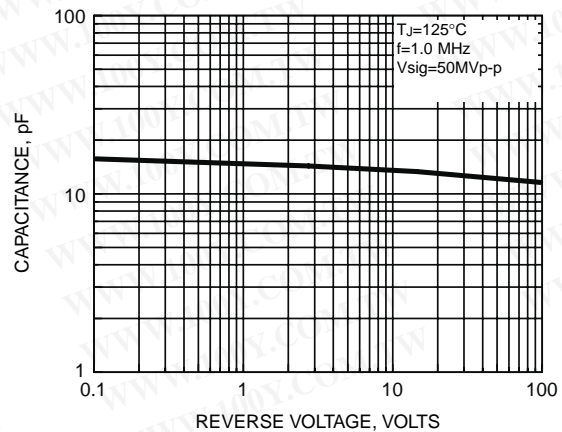

FIG. 6 - TYPICAL JUNCTION CAPACITANCE PER LEG



勝特力材料 886-3-5753170
 勝特力电子(上海) 86-21-54151736
 勝特力电子(深圳) 86-755-83298787
 Http://www.100y.com.tw