

THREE TERMINAL LOW DROPOUT VOLTAGE REGULATOR

The μ PC24A00 Series is a low dropout voltage three terminal regulator that has realized a minimum voltage differential between the I/O of no more than 1 V when the output current is 2 A through the employment of a PNP transistor at the output stage.

Due to its ability to achieve a greater reduction in the power loss compared with conventional three-terminal regulators, the μ PC24A00 Series is ideal for use as the secondary side smoothing circuit of a power supply.

FEATURES

- Output current in excess of 2.0 A
- High accuracy of output voltage
 $\Delta V_o = \pm 2\% \text{ MAX. (} T_J = 25^\circ\text{C, } I_o = 1 \text{ A)}$
- Low dropout voltage
 $V_{DIF} = 1 \text{ V MAX. (} I_o = 2 \text{ A)}$
- On-chip thermal shut down circuit, over-current protection circuit and safe operating area protection circuit

PIN CONFIGURATION (Marking Side)

3-pin plastic SIP (MP-45G)

μ PC24A05HF, 24A12HF, 24A15HF

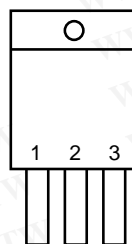

1: INPUT
 2: GND
 3: OUTPUT

ORDERING INFORMATION

Part Number	Package	Output Voltage
μ PC24A05HF	3-pin plastic SIP (MP-45G) (isolated TO-220)	5 V
μ PC24A12HF	3-pin plastic SIP (MP-45G) (isolated TO-220)	12 V
μ PC24A15HF	3-pin plastic SIP (MP-45G) (isolated TO-220)	15 V

勝特力材料 886-3-5753170
 勝特力电子(上海) 86-21-54151736
 勝特力电子(深圳) 86-755-83298787
[Http://www.100y.com.tw](http://www.100y.com.tw)

The information in this document is subject to change without notice. Before using this document, please confirm that this is the latest version.
 Not all devices/types available in every country. Please check with local NEC representative for availability and additional information.

BLOCK DIAGRAM

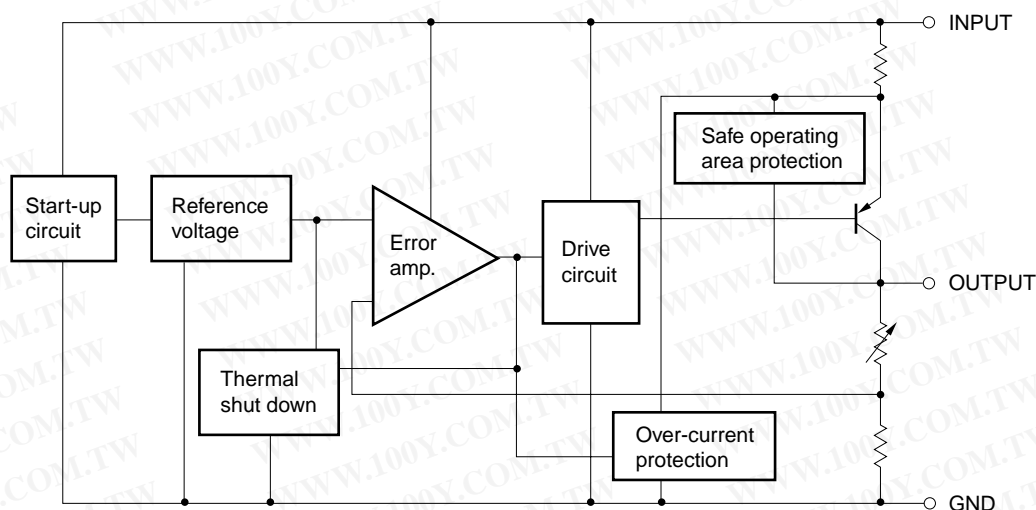

ABSOLUTE MAXIMUM RATINGS (T_A = 25°C, Unless Otherwise Specified)

Parameter	Symbol	Rating	Unit
Input voltage	V _{IN}	-0.3 to +36	V
Total power consumption	P _T	20 ^{Note}	W
Operating ambient temperature	T _A	-20 to +85	°C
Storage temperature	T _{stg}	-55 to +150	°C
Operating junction temperature	T _J	-20 to +150	°C
Thermal resistance (junction to case)	R _{th (J-C)}	5	°C/W
Thermal resistance (junction to ambient)	R _{th (J-A)}	65	°C/W

Note Internally limited. When operating junction temperature rise up to 150°C, the internal circuit shutdown output voltage.

Caution Product quality may suffer if the absolute maximum rating is exceeded even momentarily for any parameter. That is, the absolute maximum ratings are rated values at which the product is on the verge of suffering physical damage, and therefore the product must be used under conditions that ensure that the absolute maximum ratings are not exceeded.

勝特力材料 886-3-5753170
 勝特力电子(上海) 86-21-54151736
 勝特力电子(深圳) 86-755-83298787
[Http://www.100y.com.tw](http://www.100y.com.tw)

TYPICAL CONNECTION

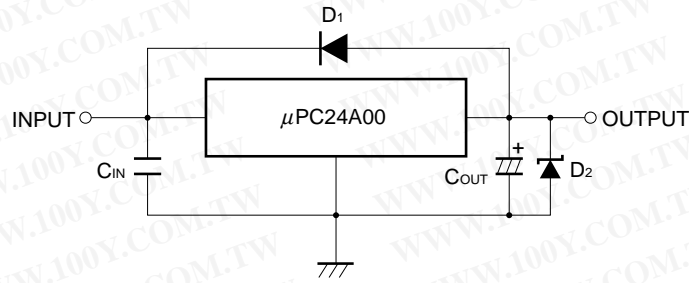

C_{IN}: 0.1 to 0.47 μF. Be sure to connect to prevent abnormal oscillation. When using capacitors, film capacitors with excellent voltage and temperature characteristics are recommended. Be aware that some monolithic ceramic capacitors have inferior temperature and voltage characteristics. When using a monolithic ceramic capacitor, C_{IN} requires a capacitor that can secure this capacity within the voltage and temperature range used.

C_{OUT}: 10 μF or higher. Be sure to connect to prevent oscillation and to improve transient load stabilization.

Remark Connect C_{IN} and C_{OUT} as close as possible to the IC pins (within 2 cm).

D₁: V_o > V_{IN} required

D₂: Schottky barrier diode required for when V_o < GND.

RECOMMENDED OPERATING CONDITIONS

Parameter	Symbol	Condition	MIN.	TYP.	MAX.	Unit
Input voltage	V _{IN}	μPC24A05HF	6	9	15	V
		μPC24A12HF	13	18	22	V
		μPC24A15HF	16	22	25	V
Output current	I _o	All	0		2	A
Operating junction temperature	T _J	All	-20		+125	°C

Caution The recommended operating range may be exceeded without causing any problems provided that the absolute maximum ratings are not exceeded. However, if the device is operated in a way that exceeds the recommended operating conditions, the margin between the actual conditions of use and the absolute maximum ratings is small, and therefore thorough evaluation is necessary. The recommended operating conditions do not imply that the device can be used with all values at their maximum values.

勝特力材料 886-3-5753170
 勝特力电子(上海) 86-21-54151736
 勝特力电子(深圳) 86-755-83298787
[Http://www.100y.com.tw](http://www.100y.com.tw)

ELECTRICAL CHARACTERISTICS

μPC24A05 (T_J = 25°C, V_{IN} = 9 V, I_o = 1 A, Unless Otherwise Specified)

Parameter	Symbol	Condition	MIN.	TYP.	MAX.	Unit
Output voltage	V _o		4.9	5.0	5.1	V
		0°C ≤ T _J ≤ 125°C, 6 V ≤ V _{IN} ≤ 15 V, 5 mA ≤ I _o ≤ 2 A	4.85		5.15	V
Line regulation	REG _{IN}	6 V ≤ V _{IN} ≤ 15 V		6	50	mV
Load regulation	REG _L	5 mA ≤ I _o ≤ 2 A		3	50	mV
Quiescent current	I _{BIAS}	I _o = 0 A		3	5.0	mA
		I _o = 2 A		15	30	mA
Quiescent current change	ΔI _{BIAS}	6 V ≤ V _{IN} ≤ 15 V, I _o = 2 A			20	mA
Output noise voltage	V _n	10 Hz ≤ f ≤ 100 kHz		150		μV _{r.m.s.}
Ripple rejection	R·R	f = 120 Hz, 6.5 V ≤ V _{IN} ≤ 16.5 V	50	60		dB
Dropout voltage	V _{DIF}	0°C ≤ T _J ≤ 125°C, I _o = 2 A			1.0	V
Short circuit current	I _{o short}	V _{IN} = 15V		1.3		A
Peak output current	I _{o peak}	V _{IN} = 9 V	2.8	3.5	4.2	A
Temperature coefficient of output voltage	ΔV _o /ΔT	0°C ≤ T _J ≤ 125°C, I _o = 5 mA		0.5		mV/°C

μPC24A12 (T_J = 25°C, V_{IN} = 18 V, I_o = 1 A, Unless Otherwise Specified)

Parameter	Symbol	Condition	MIN.	TYP.	MAX.	Unit
Output voltage	V _o		11.75	12.0	12.25	V
		0°C ≤ T _J ≤ 125°C, 13 V ≤ V _{IN} ≤ 22 V, 5 mA ≤ I _o ≤ 2 A	11.65		12.35	V
Line regulation	REG _{IN}	13 V ≤ V _{IN} ≤ 22 V		12	100	mV
Load regulation	REG _L	5 mA ≤ I _o ≤ 2 A		6	100	mV
Quiescent current	I _{BIAS}	I _o = 0 A		3	5.0	mA
		I _o = 2 A		15	30	mA
Quiescent current change	ΔI _{BIAS}	13 V ≤ V _{IN} ≤ 22 V, I _o = 2 A			20	mA
Output noise voltage	V _n	10 Hz ≤ f ≤ 100 kHz		220		μV _{r.m.s.}
Ripple rejection	R·R	f = 120 Hz, 13.5 V ≤ V _{IN} ≤ 23.5 V	43	50		dB
Dropout voltage	V _{DIF}	0°C ≤ T _J ≤ 125°C, I _o = 2 A			1.0	V
Short circuit current	I _{o short}	V _{IN} = 15 V		1.4		A
Peak output current	I _{o peak}	V _{IN} = 18 V	2.8	3.5	4.2	A
Temperature coefficient of output voltage	ΔV _o /ΔT	0°C ≤ T _J ≤ 125°C, I _o = 5 mA		1.0		mV/°C

勝特力材料 886-3-5753170
 勝特力电子(上海) 86-21-54151736
 勝特力电子(深圳) 86-755-83298787
[Http://www.100y.com.tw](http://www.100y.com.tw)

μPC24A15 (T_J = 25°C, V_{IN} = 22 V, I_o = 1 A, Unless Otherwise Specified)

Parameter	Symbol	Condition	MIN.	TYP.	MAX.	Unit
Output voltage	V _o		14.7	15.0	15.3	V
		0°C ≤ T _J ≤ 125°C, 16 V ≤ V _{IN} ≤ 25 V, 5 mA ≤ I _o ≤ 2 A	14.55		15.45	V
Line regulation	REG _{IN}	17 V ≤ V _{IN} ≤ 25 V		18	150	mV
Load regulation	REG _L	5 mA ≤ I _o ≤ 2 A		10	150	mV
Quiescent current	I _{BIAS}	I _o = 0 A		3	5.0	mA
		I _o = 2 A		15	30	mA
Quiescent current change	ΔI _{BIAS}	17 V ≤ V _{IN} ≤ 25 V, I _o = 2 A			20	mA
Output noise voltage	V _n	10 Hz ≤ f ≤ 100 kHz		260		μV _{r.m.s.}
Ripple rejection	R-R	f = 120 Hz, 17 V ≤ V _{IN} ≤ 27 V	40	48		dB
Dropout voltage	V _{DIF}	0°C ≤ T _J ≤ 125°C, I _o = 2 A			1.0	V
Short circuit current	I _{o short}	V _{IN} = 16 V		1.4		A
Peak output current	I _{o peak}	V _{IN} = 22 V	2.8	3.5	4.2	A
Temperature coefficient of output voltage	ΔV _o /ΔT	0°C ≤ T _J ≤ 125°C, I _o = 5 mA		1.6		mV/°C

勝特力材料 886-3-5753170
 勝特力电子(上海) 86-21-54151736
 勝特力电子(深圳) 86-755-83298787
[Http://www.100y.com.tw](http://www.100y.com.tw)

勝特力材料 886-3-5753170
 勝特力电子(上海) 86-21-54151736
 勝特力电子(深圳) 86-755-83298787
[Http://www.100y.com.tw](http://www.100y.com.tw)

TYPICAL CHARACTERISTICS (REFERENCE VALUES)

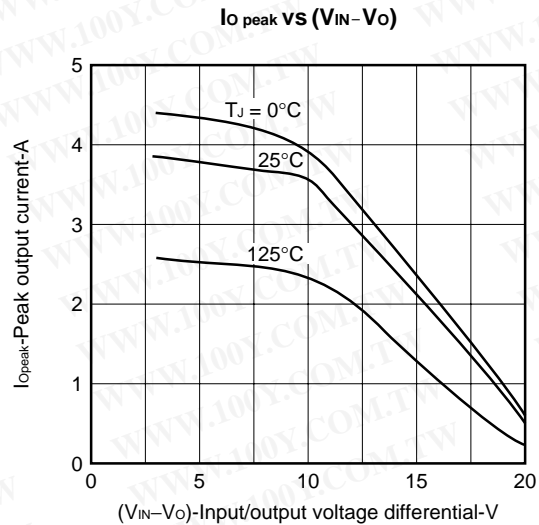
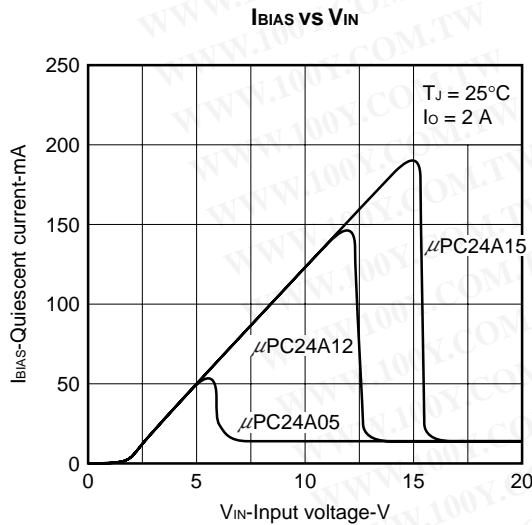
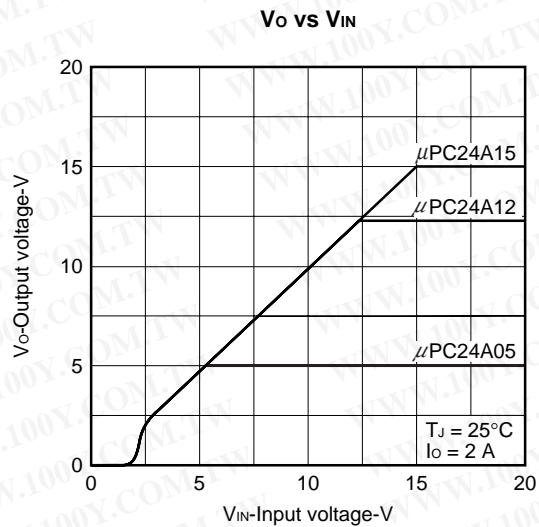
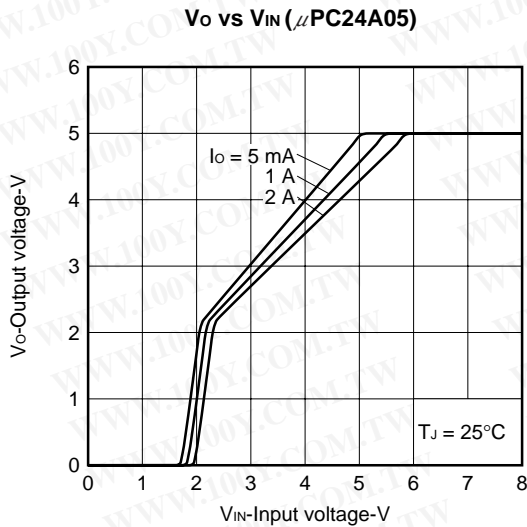
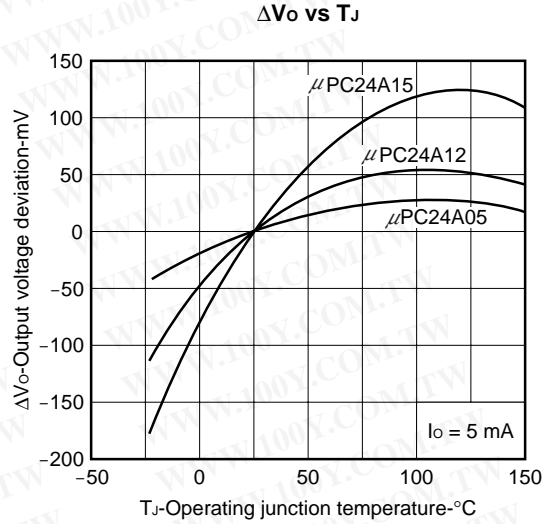
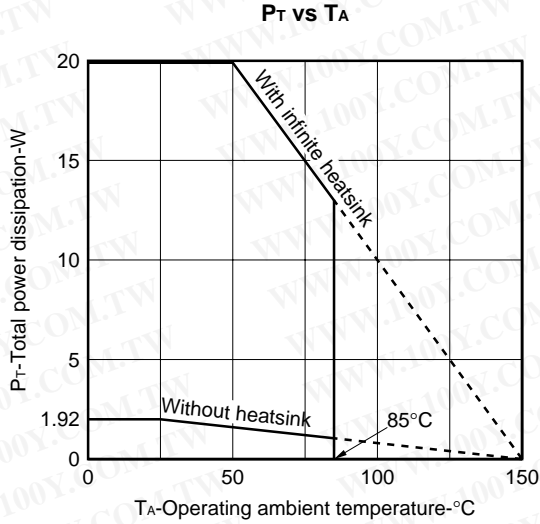

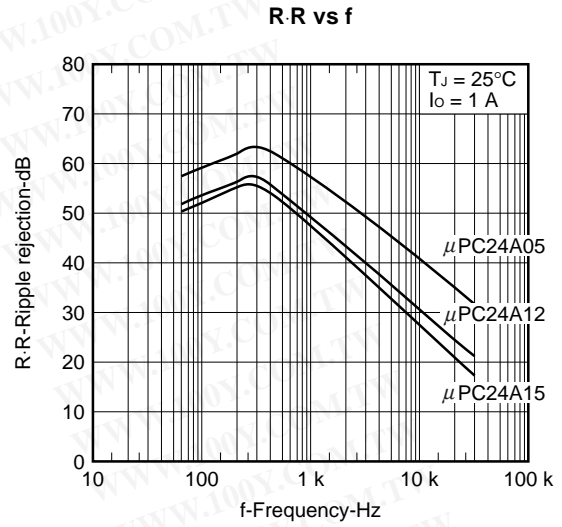
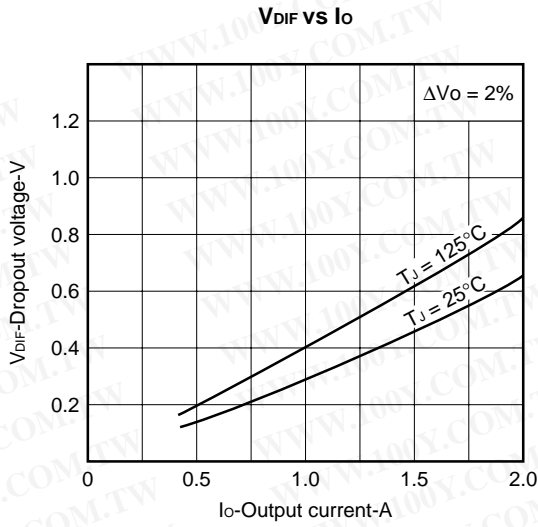

勝特力材料 886-3-5753170
 勝特力电子(上海) 86-21-54151736
 勝特力电子(深圳) 86-755-83298787
[Http://www.100y.com.tw](http://www.100y.com.tw)

PACKAGE DRAWINGS

3PIN PLASTIC SIP (MP-45G)

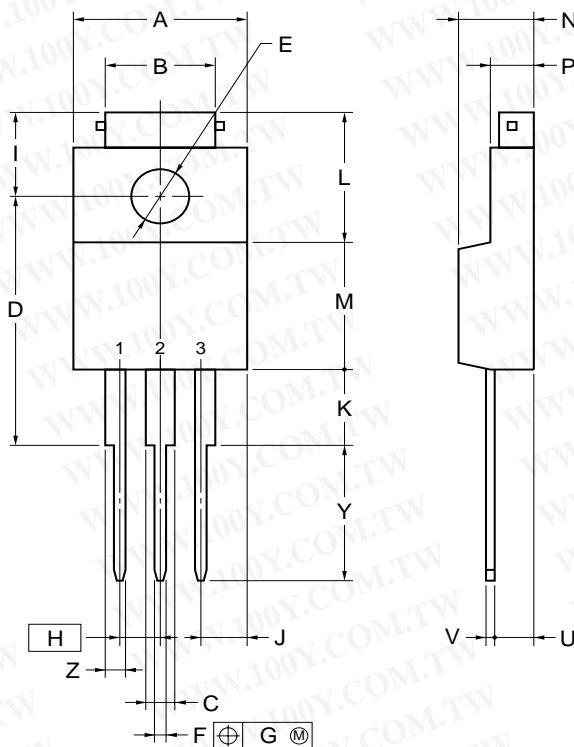

NOTE

Each lead centerline is located within 0.25 mm of its true position (T.P.) at maximum material condition.

ITEM	MILLIMETERS
A	10.0±0.2
B	7.0±0.2
C	1.50±0.2
D	17.0±0.3
E	<i>f</i> 3.3±0.2
F	0.75±0.10
G	0.25
H	2.54 (T.P.)
I	5.0±0.3
J	2.46±0.2
K	5.0±0.2
L	8.5±0.2
M	8.5±0.2
N	4.5±0.2
P	2.8±0.2
U	2.4±0.5
V	0.65±0.10
Y	8.9±0.7
Z	1.30±0.2

P3HF-254B-4

勝特力材料 886-3-5753170
 勝特力电子(上海) 86-21-54151736
 勝特力电子(深圳) 86-755-83298787
[Http://www.100y.com.tw](http://www.100y.com.tw)

RECOMMENDED SOLDERING CONDITIONS

The μPC2400 Series should be soldered and mounted under the following recommended conditions.

For the details of the recommended soldering conditions, refer to the document **SEMICONDUCTOR DEVICE MOUNTING TECHNOLOGY MANUAL (C10535E)**.

For soldering methods and conditions other than those recommended below, contact your NEC sales representative.

Through-Hole Device

μPC24A05HF, 24A12HF, 24A15HF: 3-Pin Plastic SIP (MP-45G) (Isolated TO-220)

Process	Conditions
Wave soldering (only to leads)	Solder temperature: 260°C or below, Flow time: 10 seconds or less.

Caution Apply wave soldering only to the pins and be careful not to bring solder into direct contact with the package.

CAUTION ON USE

- In the μPC24A00 Series, if the output is short-circuited at $V_{IN} \geq 20\text{ V}$, the output may not be restored after the short-circuit is cancelled. In this case, restore the output by lowering and then reapplying V_{IN} .
- If a lower than recommended input voltage is used in the μPC24A00 Series, a large circuit current will flow due to the saturation of the output stage transistor (refer to the reference characteristic curve of the $I_{BIAS} - V_{IN}$ characteristics). The capacitance for the input side power supply therefore needs to be only enough to enable the current to flow in this circuit at startup. Note also that a resistor cannot be inserted at the GND pin to adjust the output voltage.

REFERENCE DOCUMENTS

QUALITY GRADES ON NEC SEMICONDUCTOR DEVICES	C11531E
SEMICONDUCTOR DEVICE MOUNTING TECHNOLOGY MANUAL	C10535E
SEMICONDUCTORS SELECTION GUIDE	X10679E
SEMICONDUCTORS SELECTION GUIDE -Product and Packages- (CD-ROM)	X13769X

勝特力材料 886-3-5753170
 勝特力电子(上海) 86-21-54151736
 勝特力电子(深圳) 86-755-83298787
[Http://www.100y.com.tw](http://www.100y.com.tw)

[MEMO]

勝特力材料 886-3-5753170
勝特力电子(上海) 86-21-54151736
勝特力电子(深圳) 86-755-83298787
[Http://www.100y.com.tw](http://www.100y.com.tw)

[MEMO]

勝特力材料 886-3-5753170
勝特力电子(上海) 86-21-54151736
勝特力电子(深圳) 86-755-83298787
[Http://www.100y.com.tw](http://www.100y.com.tw)

勝特力材料 886-3-5753170
勝特力电子(上海) 86-21-54151736
勝特力电子(深圳) 86-755-83298787
[Http://www.100y.com.tw](http://www.100y.com.tw)

- **The information in this document is subject to change without notice. Before using this document, please confirm that this is the latest version.**
 - No part of this document may be copied or reproduced in any form or by any means without the prior written consent of NEC Corporation. NEC Corporation assumes no responsibility for any errors which may appear in this document.
 - NEC Corporation does not assume any liability for infringement of patents, copyrights or other intellectual property rights of third parties by or arising from use of a device described herein or any other liability arising from use of such device. No license, either express, implied or otherwise, is granted under any patents, copyrights or other intellectual property rights of NEC Corporation or others.
 - Descriptions of circuits, software, and other related information in this document are provided for illustrative purposes in semiconductor product operation and application examples. The incorporation of these circuits, software, and information in the design of the customer's equipment shall be done under the full responsibility of the customer. NEC Corporation assumes no responsibility for any losses incurred by the customer or third parties arising from the use of these circuits, software, and information.
 - While NEC Corporation has been making continuous effort to enhance the reliability of its semiconductor devices, the possibility of defects cannot be eliminated entirely. To minimize risks of damage or injury to persons or property arising from a defect in an NEC semiconductor device, customers must incorporate sufficient safety measures in its design, such as redundancy, fire-containment, and anti-failure features.
 - NEC devices are classified into the following three quality grades:
"Standard", "Special", and "Specific". The Specific quality grade applies only to devices developed based on a customer designated "quality assurance program" for a specific application. The recommended applications of a device depend on its quality grade, as indicated below. Customers must check the quality grade of each device before using it in a particular application.
 - Standard: Computers, office equipment, communications equipment, test and measurement equipment, audio and visual equipment, home electronic appliances, machine tools, personal electronic equipment and industrial robots
 - Special: Transportation equipment (automobiles, trains, ships, etc.), traffic control systems, anti-disaster systems, anti-crime systems, safety equipment and medical equipment (not specifically designed for life support)
 - Specific: Aircraft, aerospace equipment, submersible repeaters, nuclear reactor control systems, life support systems or medical equipment for life support, etc.
- The quality grade of NEC devices is "Standard" unless otherwise specified in NEC's Data Sheets or Data Books. If customers intend to use NEC devices for applications other than those specified for Standard quality grade, they should contact an NEC sales representative in advance.