

MOS INTEGRATED CIRCUIT

μ PD120Nxx Series

THREE-TERMINAL LOW-DROPOUT POSITIVE-VOLTAGE REGULATOR (OUTPUT CURRENT: 0.3 A)

DESCRIPTION

The μ PD120Nxx series provides low-voltage output regulators with the output current capacitance of 0.3 A. The output voltage varies according to the product (1.5 V, 1.8 V, 2.5 V, or 3.3 V). The circuit current is low due to the CMOS structure, so the power consumption in the ICs can be reduced. Moreover, since ICs are mounted in the small package of the μ PD120Nxx series, this contributes to the miniaturization of the application set.

FEATURES

- Output current: 0.3 A
- On-chip overcurrent protection circuit
- On-chip thermal protection circuit
- Small circuit operation current: 60 μ A TYP.

勝特力材料 886-3-5753170
 勝特力电子(上海) 86-21-54151736
 勝特力电子(深圳) 86-755-83298787
[Http://www.100y.com.tw](http://www.100y.com.tw)

APPLICATIONS

Digital TV, Audio, HDD, DVD, etc.

PIN CONFIGURATION (Marking Side)

SC-74A

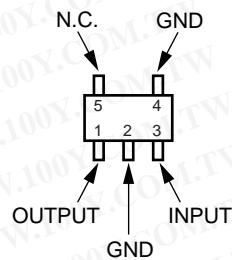

SC-62

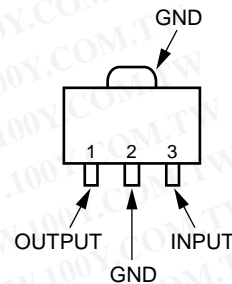

The information in this document is subject to change without notice. Before using this document, please confirm that this is the latest version.
 Not all products and/or types are available in every country. Please check with an NEC Electronics sales representative for availability and additional information.

BLOCK DIAGRAM

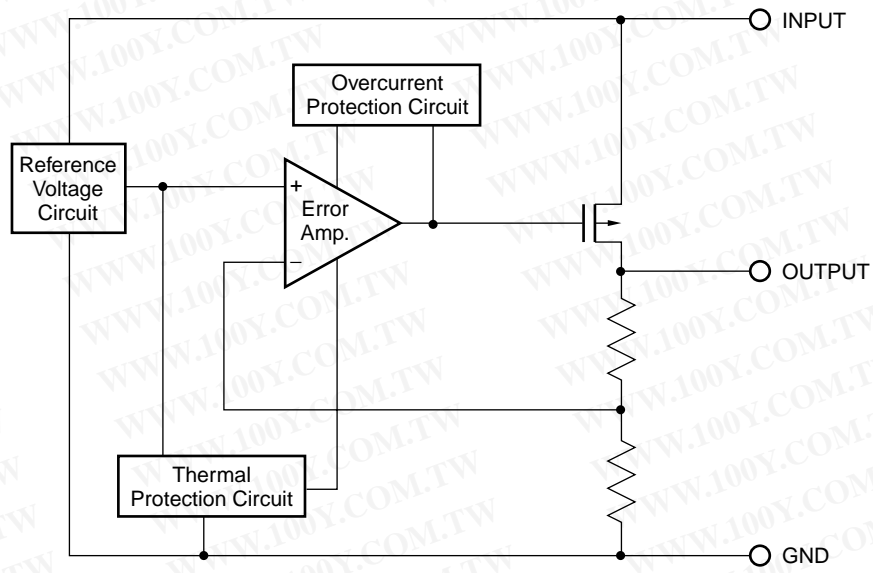

勝特力材料 886-3-5753170
 勝特力电子(上海) 86-21-54151736
 勝特力电子(深圳) 86-755-83298787
[Http://www.100y.com.tw](http://www.100y.com.tw)

ORDERING INFORMATION

Part Number	Package	Output Voltage	Marking
μPD120N15TA	SC-74A	1.5 V	K71
μPD120N15T1B	SC-62	1.5 V	7D
μPD120N18TA	SC-74A	1.8 V	K72
μPD120N18T1B	SC-62	1.8 V	7E
μPD120N25TA	SC-74A	2.5 V	K73
μPD120N25T1B	SC-62	2.5 V	7F
μPD120N33TA	SC-74A	3.3 V	K74
μPD120N33T1B	SC-62	3.3 V	7G

勝特力材料 886-3-5753170
 勝特力电子(上海) 86-21-54151736
 勝特力电子(深圳) 86-755-83298787
[Http://www.100y.com.tw](http://www.100y.com.tw)

Remark -E1 or -E2 is suffixed to the end of the part number of taping products, and -A or -AZ to that of Pb-free products. See the table below for details.

Part Number ^{Note1}	Package	Package Type
μPD120NxxTA	SC-74A	• Unit
μPD120NxxTA-A ^{Note2}	SC-74A	• Unit
μPD120NxxTA-E1	SC-74A	• 8 mm wide embossed taping • Pin 1 on take-up side • 3000 pcs/reel (MAX.)
μPD120NxxTA-E1-A ^{Note2}	SC-74A	• 8 mm wide embossed taping • Pin 1 on take-up side • 3000 pcs/reel (MAX.)
μPD120NxxTA-E2	SC-74A	• 8 mm wide embossed taping • Pin 1 on draw-out side • 3000 pcs/reel (MAX.)
μPD120NxxTA-E2-A ^{Note2}	SC-74A	• 8 mm wide embossed taping • Pin 1 on draw-out side • 3000 pcs/reel (MAX.)
μPD120NxxT1B	SC-62	• Unit
μPD120NxxT1B-AZ ^{Note3}	SC-62	• Unit
μPD120NxxT1B-E1	SC-62	• 12 mm wide embossed taping • Pin 1 on take-up side • 1000 pcs/reel (MAX.)
μPD120NxxT1B-E1-AZ ^{Note3}	SC-62	• 12 mm wide embossed taping • Pin 1 on take-up side • 1000 pcs/reel (MAX.)
μPD120NxxT1B-E2	SC-62	• 12 mm wide embossed taping • Pin 1 on draw-out side • 1000 pcs/reel (MAX.)
μPD120NxxT1B-E2-AZ ^{Note3}	SC-62	• 12 mm wide embossed taping • Pin 1 on draw-out side • 1000 pcs/reel (MAX.)

- Notes**
- xx stands for symbols that indicate the output voltage.
 - Pb-free (This product does not contain Pb in external electrode and other parts.)
 - Pb-free (This product does not contain Pb in external electrode.)

ABSOLUTE MAXIMUM RATINGS (TA = 25°C, unless otherwise specified.)

Parameter	Symbol	Rating		Unit
		μPD120NxxTA	μPD120NxxT1B	
Input Voltage	V _{IN}	-0.3 to +6		V
Power Dissipation ^{Note1}	P _T	180/510 ^{Note2}	400/2000 ^{Note3}	mW
Operating Ambient Temperature	T _A	-40 to +85		°C
Operating Junction Temperature	T _J	-40 to +150		°C
Storage Temperature	T _{stg}	-55 to +150		°C
Thermal Resistance (junction to ambient)	R _{th(J-A)}	695/245 ^{Note2}	315/62.5 ^{Note3}	°C/W

Note 1. Internally limited. When the operating junction temperature rises over 150°C, the internal circuit shuts down the output voltage.

- 2. Mounted on ceramic substrate of 75 mm² x 0.7 mm
- 3. Mounted on ceramic substrate of 16 cm² x 0.7 mm

Caution Product quality may suffer if the absolute maximum rating is exceeded even momentarily for any parameter. That is, the absolute maximum ratings are rated values at which the product is on the verge of suffering physical damage, and therefore the product must be used under conditions that ensure that the absolute maximum ratings are not exceeded.

STANDARD CONNECTION

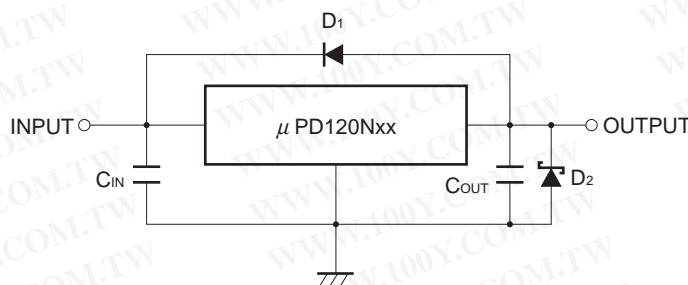

C_{IN}: 0.1 μF or higher. Set this value according to the length of the line between the regulator and INPUT pin. Be sure to connect C_{IN} to prevent parasitic oscillation. If using a laminated ceramic capacitor, it is necessary to ensure that C_{IN} is 0.1 μF or higher for the voltage and temperature range to be used.

C_{OUT}: 10 μF or higher. Be sure to connect C_{OUT} to prevent oscillation and improve excessive load regulation. Place C_{IN} and C_{OUT} as close as possible to the IC pins (within 2 cm). Be sure to use the capacitor of 10 μF or higher of capacity values and 1 to 8 Ω of equivalent series resistance under an operating condition.

D1: If the OUTPUT pin has a higher voltage than the INPUT pin, connect a diode.

D2: If the OUTPUT pin has a lower voltage than the GND pin, connect a schottky barrier diode.

Caution Make sure that no voltage is applied to the OUTPUT pin from external.

勝特力材料 886-3-5753170
 勝特力电子(上海) 86-21-54151736
 勝特力电子(深圳) 86-755-83298787
[Http://www.100y.com.tw](http://www.100y.com.tw)

RECOMMENDED OPERATING CONDITIONS

Parameter	Symbol	Type Number	MIN.	TYP.	MAX.	Unit
Input Voltage	V _{IN}	μPD120N15	3.0		5.5	V
		μPD120N18	3.2		5.5	V
		μPD120N25	4.5		5.5	V
		μPD120N33	4.5		5.5	V
Output Current	I _o	All	0		0.3	A
Operating Ambient Temperature	T _A	All	-40		+85	°C
Operating Junction Temperature	T _J	All	-40		+125	°C

Caution Use of conditions other than the above-listed recommended operating conditions is not a problem as long as the absolute maximum ratings are not exceeded. However, since the use of such conditions diminishes the margin of safety, careful evaluation is required before such conditions are used. Moreover, using the MAX. value for all the recommended operating conditions is not guaranteed to be safe.

ELECTRICAL CHARACTERISTICS

μPD120N15 (T_J = 25°C, V_{IN} = 5.0 V, I_o = 0.15 A, C_{IN} = 0.1 μF, C_{OUT} = 10 μF, unless otherwise specified.)

Parameter	Symbol	Conditions	MIN.	TYP.	MAX.	Unit
Output Voltage	V _{O1}		1.47	1.5	1.53	V
	V _{O2}	3.0 V ≤ V _{IN} ≤ 5.5 V, 0 A ≤ I _o ≤ 0.3 A	1.455	-	1.545	V
Line Regulation	REG _{IN}	3.0 V ≤ V _{IN} ≤ 5.5 V	-	1	30	mV
Load Regulation	REG _L	0 A ≤ I _o ≤ 0.3 A	-	2	30	mV
Quiescent Current	I _{BIAS}	I _o = 0 A	-	60	120	μA
Quiescent Current Change	ΔI _{BIAS}	3.0 V ≤ V _{IN} ≤ 5.5 V	-	-	25	μA
Output Noise Voltage	V _n	10 kHz ≤ f ≤ 100 kHz	-	100	-	μV _{r.m.s.}
Ripple Rejection	R•R	f = 1 kHz, 3.0 V ≤ V _{IN} ≤ 5.5 V	-	63	-	dB
Dropout Voltage	V _{DIF}	I _o = 0.15 A	-	0.6	0.9	V
		I _o = 0.3 A	-	1.0	-	V
Short Circuit Current	I _{short}	V _{IN} = 5 V	-	0.2	-	A
Peak Output Current	I _{opeak}	V _{IN} = 5 V	0.3	-	-	A
Temperature Coefficient of Output Voltage	ΔV _o /ΔT	I _o = 0 A, 0°C ≤ T _J ≤ 125°C	-	0.01	-	mV/°C

μPD120N18 (T_J = 25°C, V_{IN} = 5.0 V, I_o = 0.15 A, C_{IN} = 0.1 μF, C_{OUT} = 10 μF, unless otherwise specified.)

Parameter	Symbol	Conditions	MIN.	TYP.	MAX.	Unit
Output Voltage	V _{O1}		1.764	1.8	1.836	V
	V _{O2}	3.2 V ≤ V _{IN} ≤ 5.5 V, 0 A ≤ I _o ≤ 0.3 A	1.746	-	1.854	V
Line Regulation	REG _{IN}	3.2 V ≤ V _{IN} ≤ 5.5 V	-	1	30	mV
Load Regulation	REG _L	0 A ≤ I _o ≤ 0.3 A	-	2	30	mV
Quiescent Current	I _{BIAS}	I _o = 0 A	-	60	120	μA
Quiescent Current Change	ΔI _{BIAS}	3.2 V ≤ V _{IN} ≤ 5.5 V	-	-	25	μA
Output Noise Voltage	V _n	10 kHz ≤ f ≤ 100 kHz	-	120	-	μV _{r.m.s.}
Ripple Rejection	R•R	f = 1 kHz, 3.2 V ≤ V _{IN} ≤ 5.5 V	-	63	-	dB
Dropout Voltage	V _{DIF}	I _o = 0.15 A	-	0.4	0.65	V
Short Circuit Current	I _{short}	V _{IN} = 5 V	-	0.2	-	A
Peak Output Current	I _{opeak}	V _{IN} = 5 V	0.3	-	-	A
Temperature Coefficient of Output Voltage	ΔV _o /ΔT	I _o = 0 A, 0°C ≤ T _J ≤ 125°C	-	0.01	-	mV/°C

勝特力材料 886-3-5753170
 勝特力电子(上海) 86-21-54151736
 勝特力电子(深圳) 86-755-83298787
[Http://www.100y.com.tw](http://www.100y.com.tw)

μPD120N25 (T_J = 25°C, V_{IN} = 5.0 V, I_o = 0.15 A, C_{IN} = 0.1 μF, C_{OUT} = 10 μF, unless otherwise specified.)

Parameter	Symbol	Conditions	MIN.	TYP.	MAX.	Unit
Output Voltage	V _{O1}		2.45	2.5	2.55	V
	V _{O2}	4.5 V ≤ V _{IN} ≤ 5.5 V, 0 A ≤ I _o ≤ 0.3 A	2.425	–	2.575	V
Line Regulation	REG _{IN}	4.5 V ≤ V _{IN} ≤ 5.5 V	–	1	30	mV
Load Regulation	REG _L	0 A ≤ I _o ≤ 0.3 A	–	2	30	mV
Quiescent Current	I _{BIAS}	I _o = 0 A	–	60	120	μA
Quiescent Current Change	ΔI _{BIAS}	4.5 V ≤ V _{IN} ≤ 5.5 V	–	–	25	μA
Output Noise Voltage	V _n	10 kHz ≤ f ≤ 100 kHz	–	170	–	μV _{r.m.s.}
Ripple Rejection	R•R	f = 1 kHz, 4.5 V ≤ V _{IN} ≤ 5.5 V	–	60	–	dB
Dropout Voltage	V _{DIF}	I _o = 0.15 A	–	0.3	0.7	V
Short Circuit Current	I _{short}	V _{IN} = 5 V	–	0.2	–	A
Peak Output Current	I _{Opeak}	V _{IN} = 5 V	0.3	–	–	A
Temperature Coefficient of Output Voltage	ΔV _o /ΔT	I _o = 0 A, 0°C ≤ T _J ≤ 125°C	–	0.01	–	mV/°C

μPD120N33 (T_J = 25°C, V_{IN} = 5.0 V, I_o = 0.15 A, C_{IN} = 0.1 μF, C_{OUT} = 10 μF, unless otherwise specified.)

Parameter	Symbol	Conditions	MIN.	TYP.	MAX.	Unit
Output Voltage	V _{O1}		3.234	3.3	3.366	V
	V _{O2}	4.5 V ≤ V _{IN} ≤ 5.5 V, 0 A ≤ I _o ≤ 0.3 A	3.201	–	3.399	V
Line Regulation	REG _{IN}	4.5 V ≤ V _{IN} ≤ 5.5 V	–	1	30	mV
Load Regulation	REG _L	0 A ≤ I _o ≤ 0.3 A	–	2	30	mV
Quiescent Current	I _{BIAS}	I _o = 0 A	–	60	120	μA
Quiescent Current Change	ΔI _{BIAS}	4.5 V ≤ V _{IN} ≤ 5.5 V	–	–	25	μA
Output Noise Voltage	V _n	10 kHz ≤ f ≤ 100 kHz	–	220	–	μV _{r.m.s.}
Ripple Rejection	R•R	f = 1 kHz, 4.5 V ≤ V _{IN} ≤ 5.5 V	–	60	–	dB
Dropout Voltage	V _{DIF}	I _o = 0.15 A	–	0.2	0.6	V
Short Circuit Current	I _{short}	V _{IN} = 5 V	–	0.2	–	A
Peak Output Current	I _{Opeak}	V _{IN} = 5 V	0.3	–	–	A
Temperature Coefficient of Output Voltage	ΔV _o /ΔT	I _o = 0 A, 0°C ≤ T _J ≤ 125°C	–	0.01	–	mV/°C

勝特力材料 886-3-5753170
 勝特力电子(上海) 86-21-54151736
 勝特力电子(深圳) 86-755-83298787
[Http://www.100y.com.tw](http://www.100y.com.tw)

TYPICAL CHARACTERISTICS (Reference Value)

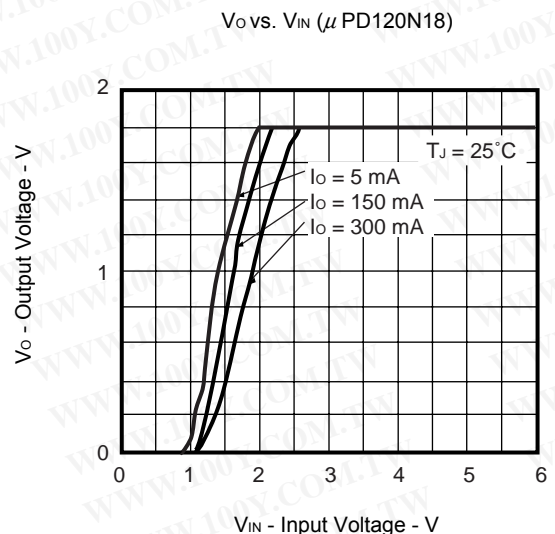
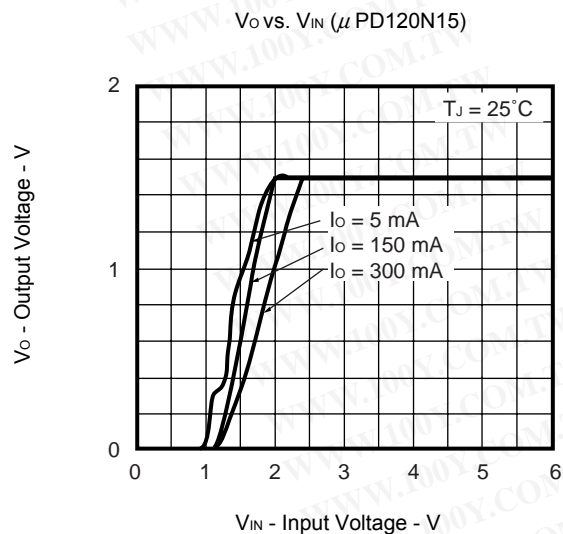
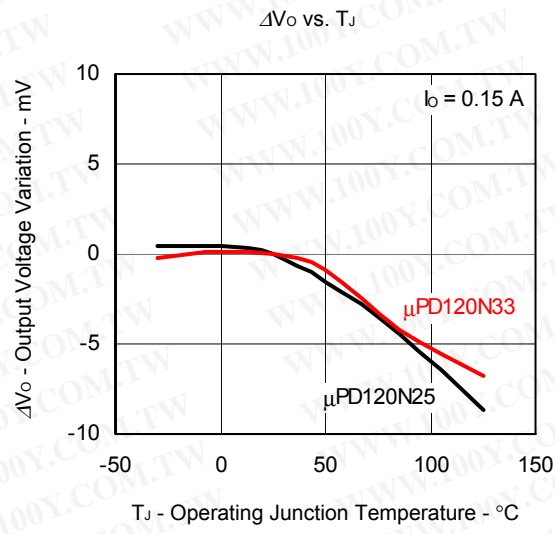
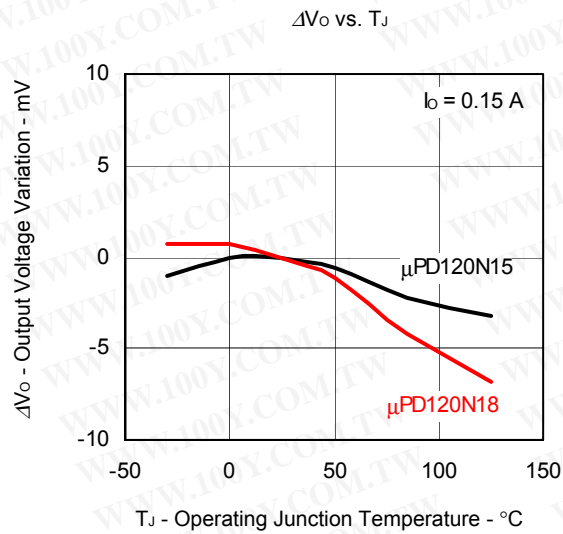
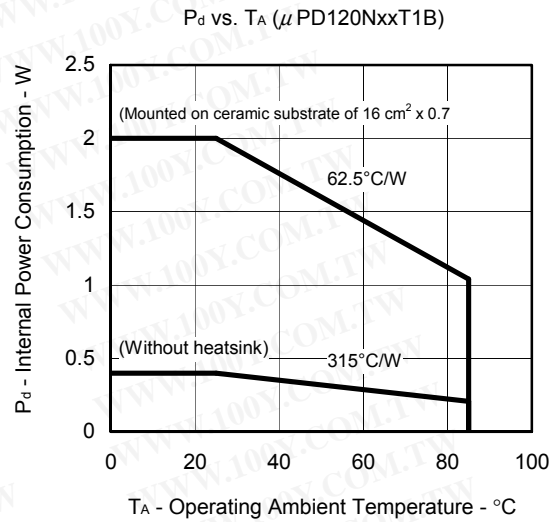
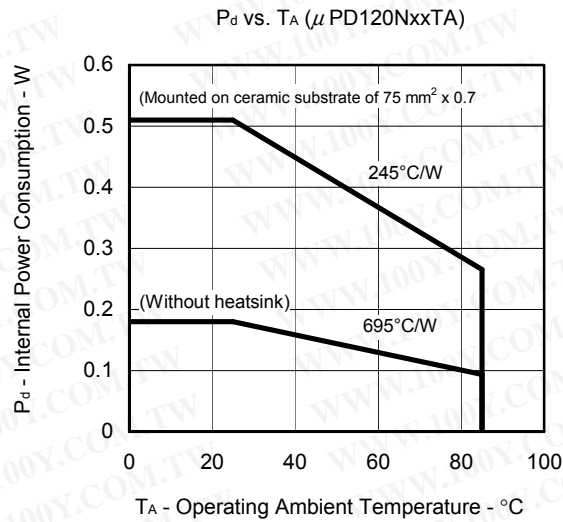

勝特力材料 886-3-5753170
 勝特力电子(上海) 86-21-54151736
 勝特力电子(深圳) 86-755-83298787
[Http://www.100y.com.tw](http://www.100y.com.tw)

V_O vs. V_{IN} (μ PD120N25)

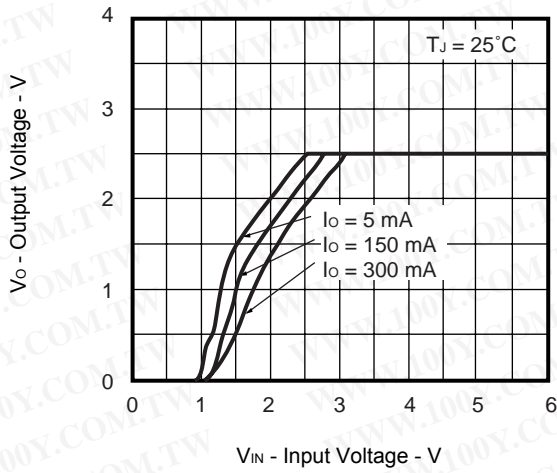

V_O vs. V_{IN} (μ PD120N33)

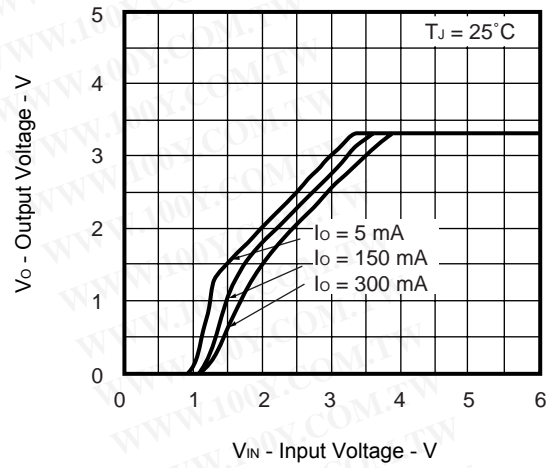

I_{BIAS} ($I_{BIAS(S)}$) vs. V_{IN} (μ PD120N15)

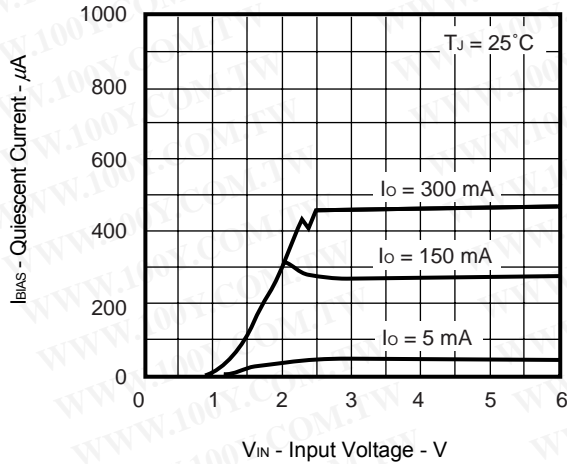

I_{BIAS} ($I_{BIAS(S)}$) vs. V_{IN} (μ PD120N18)

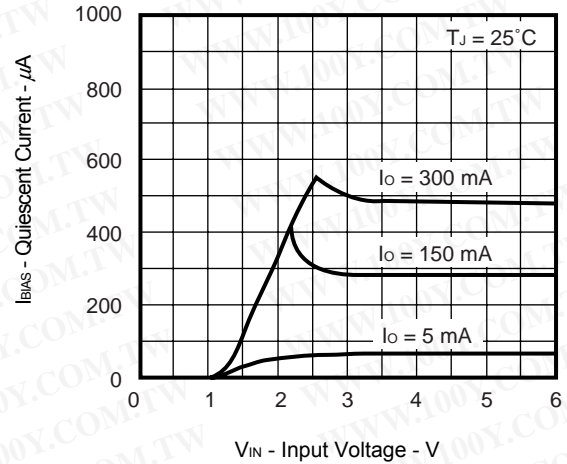

I_{BIAS} ($I_{BIAS(S)}$) vs. V_{IN} (μ PD120N25)

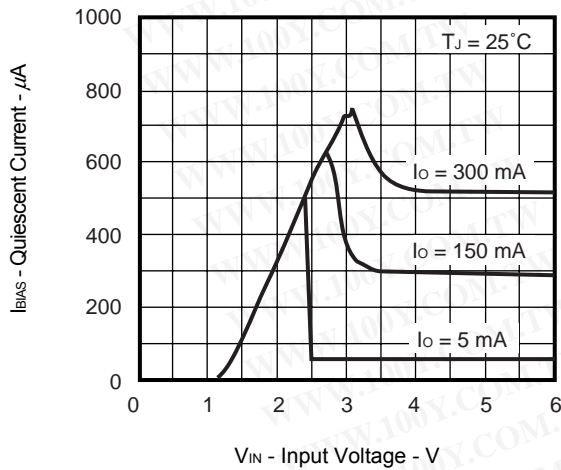

I_{BIAS} ($I_{BIAS(S)}$) vs. V_{IN} (μ PD120N33)

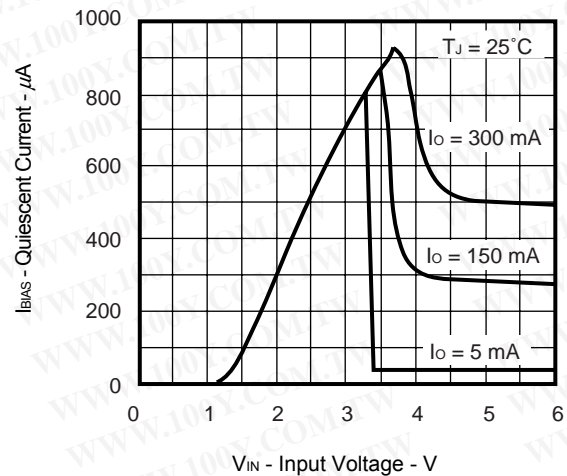

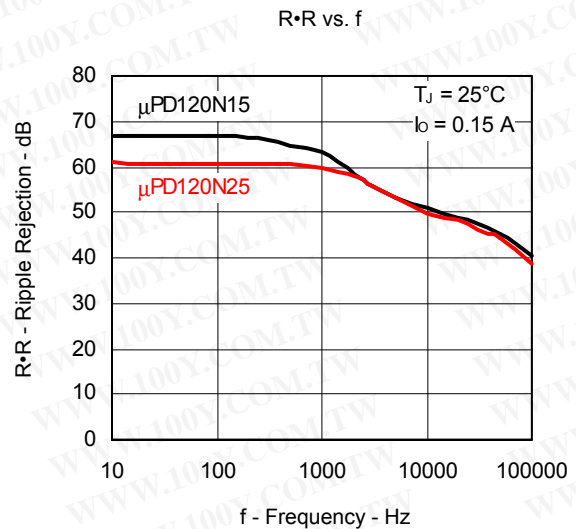
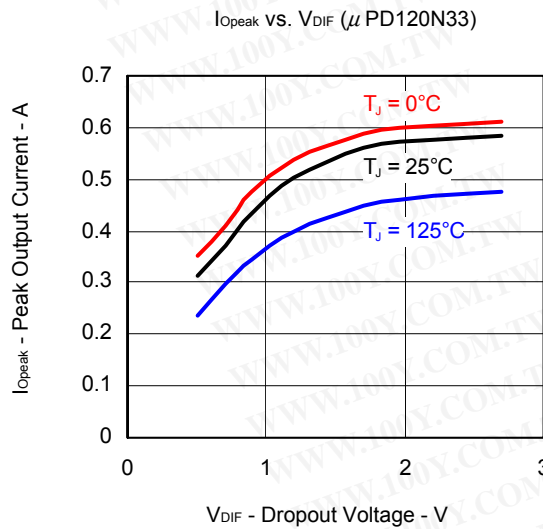
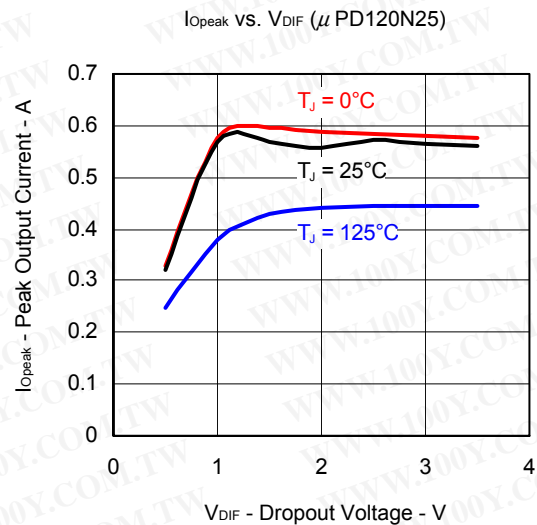
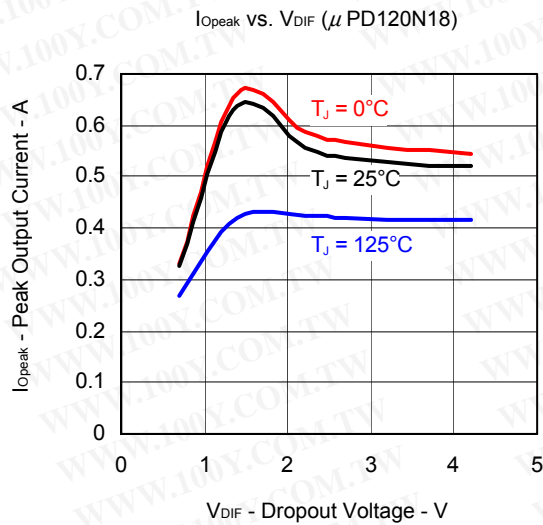
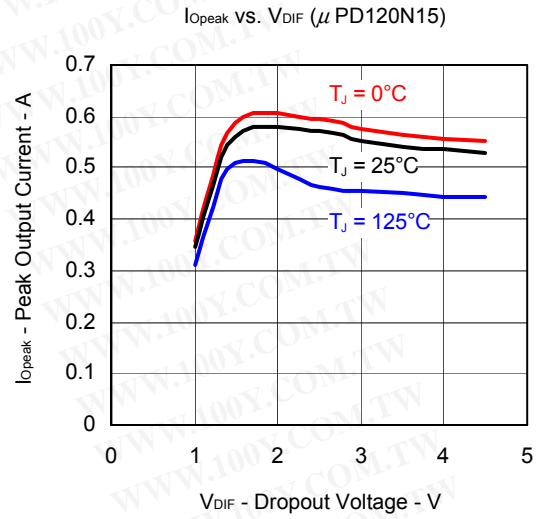
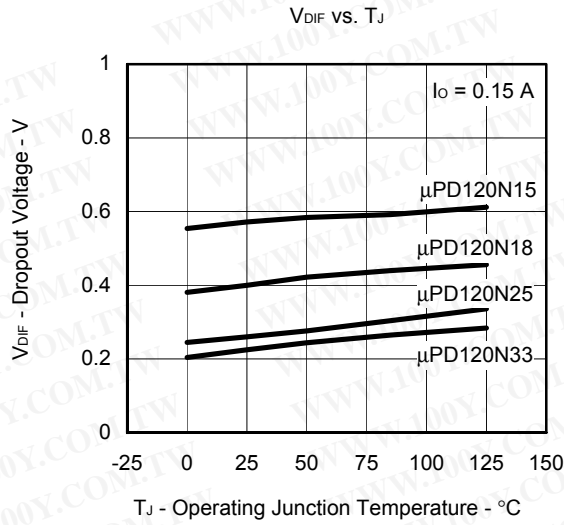

勝特力材料 886-3-5753170
勝特力电子(上海) 86-21-54151736
勝特力电子(深圳) 86-755-83298787
[Http://www.100y.com.tw](http://www.100y.com.tw)

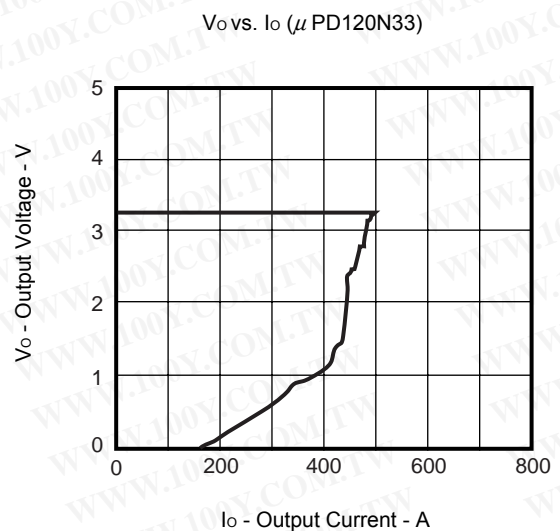
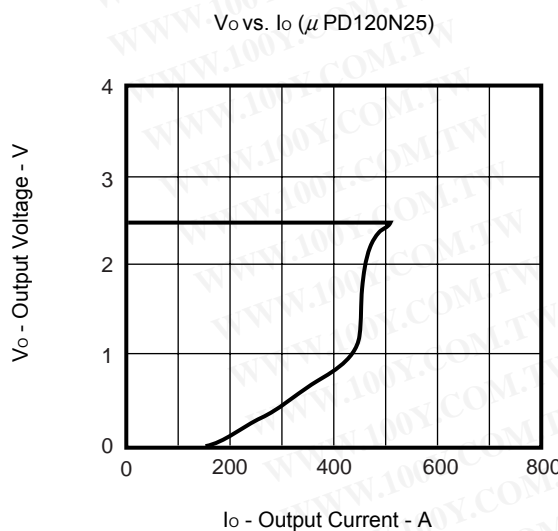
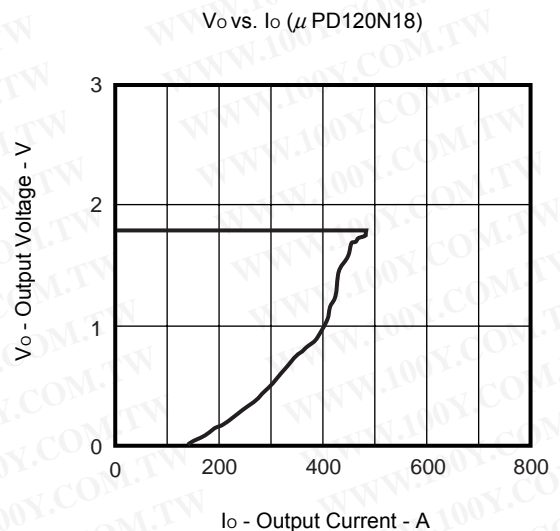
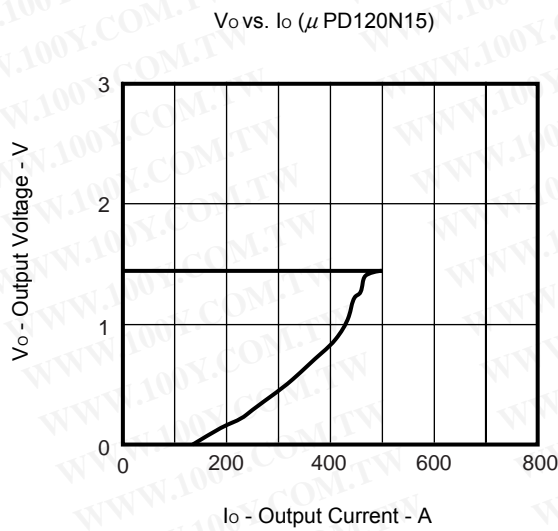
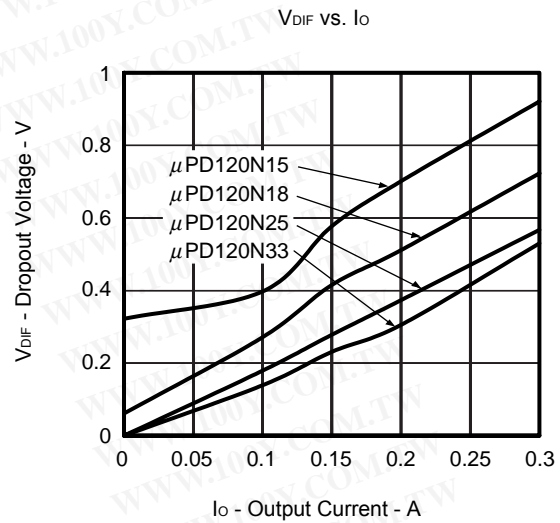
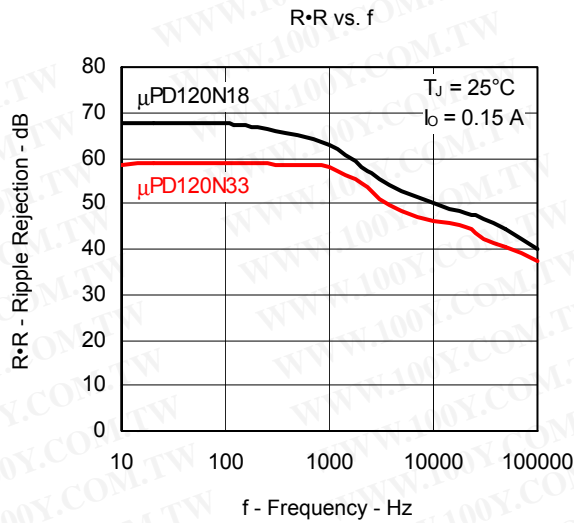

勝特力材料 886-3-5753170
 勝特力电子(上海) 86-21-54151736
 勝特力电子(深圳) 86-755-83298787
[Http://www.100y.com.tw](http://www.100y.com.tw)

PACKAGE DRAWINGS (Unit: mm)

SC-74A

5 PIN PLASTIC MINI MOLD

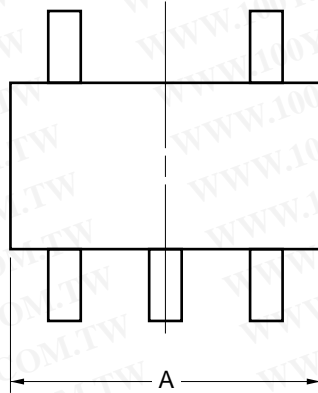

detail of lead end

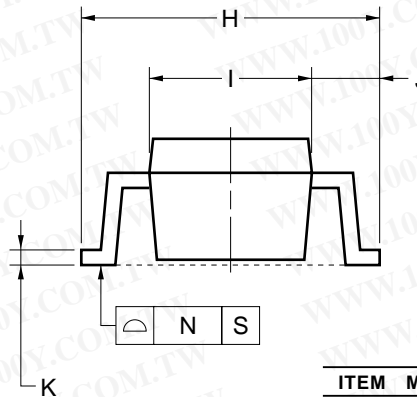
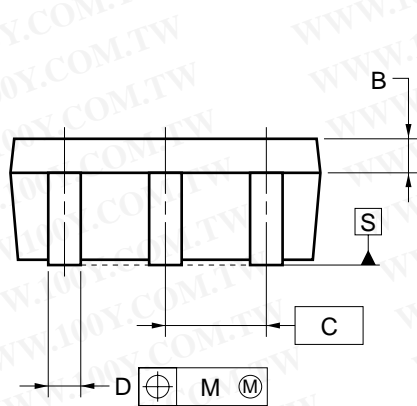
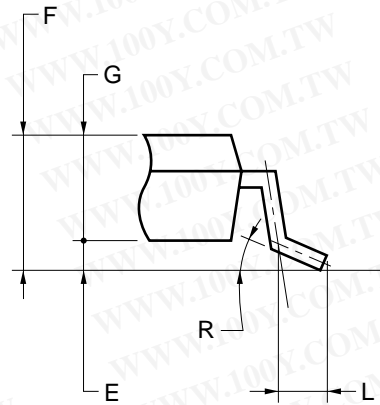

ITEM	MILLIMETERS
A	2.9±0.2
B	0.3
C	0.95 (T.P.)
D	0.32 ^{+0.05} _{-0.02}
E	0.05±0.05
F	1.4 MAX.
G	1.1 ^{+0.2} _{-0.1}
H	2.8±0.2
I	1.5 ^{+0.2} _{-0.1}
J	0.65 ^{+0.1} _{-0.15}
K	0.16 ^{+0.1} _{-0.06}
L	0.4±0.2
M	0.19
N	0.1
R	5°±5°

S5TA-95-15A

勝特力材料 886-3-5753170
 勝特力电子(上海) 86-21-54151736
 勝特力电子(深圳) 86-755-83298787
[Http://www.100y.com.tw](http://www.100y.com.tw)

SC-62

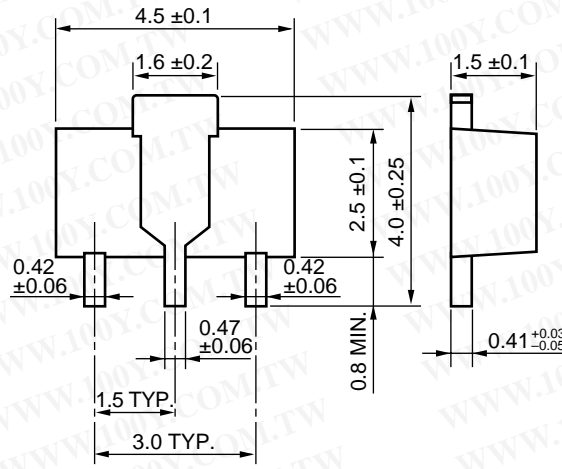

勝特力材料 886-3-5753170
 勝特力电子(上海) 86-21-54151736
 勝特力电子(深圳) 86-755-83298787
[Http://www.100y.com.tw](http://www.100y.com.tw)

RECOMMENDED SOLDERING CONDITIONS

The μPD120Nxx series should be soldered and mounted under the following recommended conditions.
 For soldering methods and conditions other than those recommended below, contact an NEC Electronics sales representative.
 For technical information, see the following website.

Semiconductor Device Mount Manual (<http://www.necel.com/pkg/en/mount/index.html>)

Type of Surface Mount Device

μPD120N15TA, μPD120N18TA, μPD120N25TA, μPD120N33TA: SC-74A
μPD120N15T1B, μPD120N18T1B, μPD120N25T1B, μPD120N33T1B: SC-62

勝特力材料 886-3-5753170
 勝特力电子(上海) 86-21-54151736
 勝特力电子(深圳) 86-755-83298787
[Http://www.100y.com.tw](http://www.100y.com.tw)

Process	Conditions	Symbol
Infrared Ray Reflow	Peak temperature: 235°C or below (Package surface temperature), Reflow time: 30 seconds or less (at 210°C or higher), Maximum number of reflows processes: 3 times or less.	IR35-00-3
Vapor Phase Soldering	Peak temperature: 215°C or below (Package surface temperature), Reflow time: 40 seconds or less (at 200°C or higher), Maximum number of reflows processes: 3 times or less.	VP15-00-3
Wave Soldering	Solder temperature: 260°C or below, Flow time: 10 seconds or less, Maximum number of flow processes: 1 time, Pre-heating temperature: 120°C or below (Package surface temperature).	WS60-00-1
Partial Heating Method	Pin temperature: 300°C or below, Heat time: 3 seconds or less (Per each side of the device).	-

μPD120N15TA-A, μPD120N18TA-A, μPD120N25TA-A, μPD120N33TA-A: SC-74A^{Note1}
μPD120N15T1B-AZ, μPD120N18T1B-AZ, μPD120N25T1B-AZ, μPD120N33T1B-AZ: SC-62^{Note2}

Process	Conditions	Symbol
Infrared Ray Reflow	Peak temperature: 260°C or below (Package surface temperature), Reflow time: 30 seconds or less (at 210°C or higher), Maximum number of reflows processes: 3 times or less.	IR60-00-3
Wave Soldering	Solder temperature: 260°C or below, Flow time: 10 seconds or less, Maximum number of flow processes: 1 time, Pre-heating temperature: 120°C or below (Package surface temperature).	WS60-00-1
Partial Heating Method	Pin temperature: 300°C or below, Heat time: 3 seconds or less (Per each side of the device).	-

- Notes 1.** Pb-free (This product does not contain Pb in external electrode and other parts.)
2. Pb-free (This product does not contain Pb in external electrode.)

Caution Do not use different soldering methods together (except for partial heating).

Remark Flux: Rosin-based flux with low chlorine content (chlorine 0.2 Wt% or below) is recommended.

NOTES FOR CMOS DEVICES

① VOLTAGE APPLICATION WAVEFORM AT INPUT PIN

Waveform distortion due to input noise or a reflected wave may cause malfunction. If the input of the CMOS device stays in the area between V_{IL} (MAX) and V_{IH} (MIN) due to noise, etc., the device may malfunction. Take care to prevent chattering noise from entering the device when the input level is fixed, and also in the transition period when the input level passes through the area between V_{IL} (MAX) and V_{IH} (MIN).

② HANDLING OF UNUSED INPUT PINS

Unconnected CMOS device inputs can be cause of malfunction. If an input pin is unconnected, it is possible that an internal input level may be generated due to noise, etc., causing malfunction. CMOS devices behave differently than Bipolar or NMOS devices. Input levels of CMOS devices must be fixed high or low by using pull-up or pull-down circuitry. Each unused pin should be connected to V_{DD} or GND via a resistor if there is a possibility that it will be an output pin. All handling related to unused pins must be judged separately for each device and according to related specifications governing the device.

③ PRECAUTION AGAINST ESD

A strong electric field, when exposed to a MOS device, can cause destruction of the gate oxide and ultimately degrade the device operation. Steps must be taken to stop generation of static electricity as much as possible, and quickly dissipate it when it has occurred. Environmental control must be adequate. When it is dry, a humidifier should be used. It is recommended to avoid using insulators that easily build up static electricity. Semiconductor devices must be stored and transported in an anti-static container, static shielding bag or conductive material. All test and measurement tools including work benches and floors should be grounded. The operator should be grounded using a wrist strap. Semiconductor devices must not be touched with bare hands. Similar precautions need to be taken for PW boards with mounted semiconductor devices.

④ STATUS BEFORE INITIALIZATION

Power-on does not necessarily define the initial status of a MOS device. Immediately after the power source is turned ON, devices with reset functions have not yet been initialized. Hence, power-on does not guarantee output pin levels, I/O settings or contents of registers. A device is not initialized until the reset signal is received. A reset operation must be executed immediately after power-on for devices with reset functions.

⑤ POWER ON/OFF SEQUENCE

In the case of a device that uses different power supplies for the internal operation and external interface, as a rule, switch on the external power supply after switching on the internal power supply. When switching the power supply off, as a rule, switch off the external power supply and then the internal power supply. Use of the reverse power on/off sequences may result in the application of an overvoltage to the internal elements of the device, causing malfunction and degradation of internal elements due to the passage of an abnormal current.

The correct power on/off sequence must be judged separately for each device and according to related specifications governing the device.

⑥ INPUT OF SIGNAL DURING POWER OFF STATE

Do not input signals or an I/O pull-up power supply while the device is not powered. The current injection that results from input of such a signal or I/O pull-up power supply may cause malfunction and the abnormal current that passes in the device at this time may cause degradation of internal elements. Input of signals during the power off state must be judged separately for each device and according to related specifications governing the device.

勝特力材料 886-3-5753170
勝特力电子(上海) 86-21-54151736
勝特力电子(深圳) 86-755-83298787
[Http://www.100y.com.tw](http://www.100y.com.tw)

REFERENCE DOCUMENTS

Document Name	Document No.
Usage of Three-Terminal Regulators User's Manual	G12702E
Voltage Regulator of SMD Information	G11872E
Semiconductor Device Mount Manual	http://www.necel.com/pkg/en/mount/index.html
SEMICONDUCTOR SELECTION GUIDE - Products and Packages-	X13769X

- **The information in this document is current as of February, 2005. The information is subject to change without notice. For actual design-in, refer to the latest publications of NEC Electronics data sheets or data books, etc., for the most up-to-date specifications of NEC Electronics products. Not all products and/or types are available in every country. Please check with an NEC Electronics sales representative for availability and additional information.**

- No part of this document may be copied or reproduced in any form or by any means without the prior written consent of NEC Electronics. NEC Electronics assumes no responsibility for any errors that may appear in this document.
- NEC Electronics does not assume any liability for infringement of patents, copyrights or other intellectual property rights of third parties by or arising from the use of NEC Electronics products listed in this document or any other liability arising from the use of such products. No license, express, implied or otherwise, is granted under any patents, copyrights or other intellectual property rights of NEC Electronics or others.
- Descriptions of circuits, software and other related information in this document are provided for illustrative purposes in semiconductor product operation and application examples. The incorporation of these circuits, software and information in the design of a customer's equipment shall be done under the full responsibility of the customer. NEC Electronics assumes no responsibility for any losses incurred by customers or third parties arising from the use of these circuits, software and information.
- While NEC Electronics endeavors to enhance the quality, reliability and safety of NEC Electronics products, customers agree and acknowledge that the possibility of defects thereof cannot be eliminated entirely. To minimize risks of damage to property or injury (including death) to persons arising from defects in NEC Electronics products, customers must incorporate sufficient safety measures in their design, such as redundancy, fire-containment and anti-failure features.
- NEC Electronics products are classified into the following three quality grades: "Standard", "Special" and "Specific".

The "Specific" quality grade applies only to NEC Electronics products developed based on a customer-designated "quality assurance program" for a specific application. The recommended applications of an NEC Electronics product depend on its quality grade, as indicated below. Customers must check the quality grade of each NEC Electronics product before using it in a particular application.

"Standard": Computers, office equipment, communications equipment, test and measurement equipment, audio and visual equipment, home electronic appliances, machine tools, personal electronic equipment and industrial robots.

"Special": Transportation equipment (automobiles, trains, ships, etc.), traffic control systems, anti-disaster systems, anti-crime systems, safety equipment and medical equipment (not specifically designed for life support).

"Specific": Aircraft, aerospace equipment, submersible repeaters, nuclear reactor control systems, life support systems and medical equipment for life support, etc.

The quality grade of NEC Electronics products is "Standard" unless otherwise expressly specified in NEC Electronics data sheets or data books, etc. If customers wish to use NEC Electronics products in applications not intended by NEC Electronics, they must contact an NEC Electronics sales representative in advance to determine NEC Electronics' willingness to support a given application.

(Note)

- (1) "NEC Electronics" as used in this statement means NEC Electronics Corporation and also includes its majority-owned subsidiaries.
- (2) "NEC Electronics products" means any product developed or manufactured by or for NEC Electronics (as defined above).