

QUARTZ HALOGEN LAMPS • DOUBLE ENDED

JPD SERIES

- Only for Use in Approved Enclosed Halogen Fixtures
- Recessed Single Contact Base - R7s-18 Base
- Operate in Any Position

勝特力材料 886-3-5753170
 勝特力电子(上海) 86-21-54151736
 勝特力电子(深圳) 86-755-83298787
[Http://www.100y.com.tw](http://www.100y.com.tw)



Watts	Ushio Ordering Code	Ushio Lamp Code	Dimensions mm			Filament Type	Approx Lumens lm	Color Temp K	Avg Life h	Bulb Finish
			Dia (A)	OAL (B)	C-to-C (C)					
Recessed Single Contact Base – R7s-18										
150	1001106	JPD25V-150WG1 fused	15.0	66.7	64.7	CC-8	2700	2900	3000	Clear
200	1000175	DDN, JPD20V-200W	11.0	61.0	54.7	CC-8	5000	3150	100	Clear
200	1001099	JPD120V-200WG	12.0	80.3	74.9	CC-8	3460	2850	1500	Clear
300	1000292	EHP, JPD120V-300WG	15.0	80.3	74.9	CC-8	5650	2900	2000	Clear
375	1000230	DWZ, JPD30V-375W	15.0	80.3	74.9	CC-8	7500	3000	1000	Clear
400	1000293	EHR, JPD120V-400WG	15.0	80.3	74.9	CC-8	7750	2900	2000	Clear
400	1000498	FDA, JPD120V-400W	15.0	80.3	74.9	CC-8	10400	3200	200	Clear
420	1000472	FAL, JPD120V-420WC	14.0	66.7	62.0	CC-8	11000	3200	75	Clear
420	1000518	FFM, JPD120V-420WC1	15.0	80.3	74.9	CC-8	11000	3200	75	Clear
600	1000486	FCB, JPD120V-600WD	15.0	95.0	89.6	CC-8	17000	3250	75	Clear
600	1002230	FCB-5, JPD125V-600WD	15.0	95.3	89.6	CC-8	—	3250	75	Clear
600	1000517	FFJ, JPD120V-600WCG	15.0	66.7	61.3	CC-8	17000	3200	75	Clear
600	1000508	FEA, JPD240V-600WC	15.0	95.0	89.6	CC-8	15000	3200	75	Clear
650	1000229	DWY/FAB, JPD120V-650WS	15.0	80.3	74.9	CC-8	20000	3400	25	Clear
650	1000471	FAD, JPD120V-650WC	15.0	80.3	74.9	CC-8	16500	3200	100	Clear
650	1000482	FBX, JPD120V-650WCF	15.0	80.3	74.9	CC-8	16000	3200	100	Frosted
650	1000485	FCA, JPD120V-650WSF	15.0	80.3	74.9	CC-8	19000	3400	35	Frosted
650	1001103	JPD220V-650WC	15.0	80.3	74.9	CC-8	16300	3200	75	Clear
800	1000238	DXX/220V, JPD220V-800WC1	15.0	80.3	74.9	CC-8	20500	3200	75	Clear
800	1000235	DXV, JPD230V-800WS	15.0	80.3	74.9	CC-8	24800	3400	15	Clear
800	1000239	DXX/230V, JPD230V-800WC	15.0	80.3	74.9	CC-8	20000	3200	75	Clear
800	1001613	DXV, JPD240V-800WS	15.0	80.3	74.9	CC-8	24800	3400	15	Clear
800	1000240	DXX/240V, JPD240V-800WC	15.0	80.3	74.9	CC-8	20500	3200	75	Clear
1000	1000236	DXW, JPD120V-1000WC5	18.0	95.0	89.6	CC-8	28000	3200	150	Clear
1000	1000234	DXN, JPD120V-1000WS1	18.0	95.0	89.6	CC-8	31000	3400	50	Clear
1000	1000511	FER, JPD120V-1000WC6	19.0	143.5	138.1	CC-8	27500	3200	500	Clear
1000	1000228	DWT, JPD120V-1000WB1	19.0	143.5	138.1	CC-8	23400	3000	2000	Clear
1000	1000068	BRH, JPD120V-1000WC1	18.0	95.0	89.6	CC-8	30000	3350	75	Clear
1000	1000241	DYA, JPD120V-1000WC2	18.0	109.5	104.1	CC-8	28000	3200	200	Clear
1000	1000483	FBY, JPD120V-1000WC5F	18.0	95.0	89.6	CC-8	26000	3200	150	Frosted
1000	1001102	JPD220V-1000WC	18.0	95.0	89.6	CC-8	25000	3200	120	Clear
1050	1000322	ELJ, JPD120V-1050WS	18.0	119.6	114.2	CC-8	30000	3200	75	Clear
2000	1000516	FEY, JPD120V-2000WC	29.0	143.5	138.1	CC-8	57000	3200	400	Clear
2000	1000515	FEX/240V, JPD240V-2000WC1	29.0	143.5	138.1	CC-8	50000	3200	300	Clear

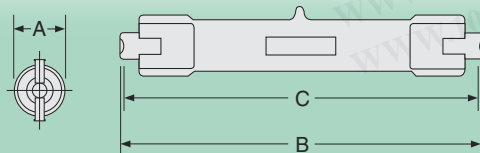

R7s-18



TUNGSTEN HALOGEN LAMPS • SINGLE ENDED

JA & JF SERIES

- Only for Use in Approved Enclosed Halogen Fixtures
- P14.5s & PK30d Base
- 13.2 & 28 Volts



Watts	Ushio Ordering Code	Ushio Lamp Code	Volts	Dimensions mm			Filament Type	Luminous Flux lm	Color Temp K	Avg Life h
				Dia (A)	OAL (B)	Length (L1)				
P14.5s Base										
55	1000790	JA12V-55W H1-55	13.2	8.5	67.5	25.25	C-8	1550	3000	150
70	1000800	JA24V-70W	28	8.5	49.0	—	—	1900	—	150
100	1000785	JA12V-100W H1-100	13.2	8.5	67.5	25.25	C-8	2700	3050	50
PK30d Base										
			Amperage							
100	1001062	JF6.6A-100W/PK30D	6.6	13.5	—	40.0	C-6	2400	3000	1000

勝特力材料 886-3-5753170
 勝特力电子(上海) 86-21-54151736
 勝特力电子(深圳) 86-755-83298787
[Http://www.100y.com.tw](http://www.100y.com.tw)

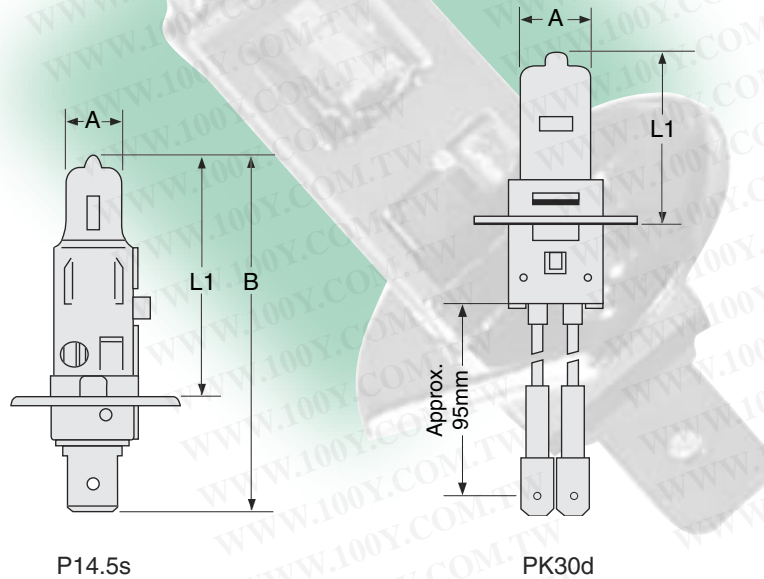

HALOGEN LOW VOLTAGE BAYONET

JC SERIES

- Only for Use in Approved Enclosed Halogen Fixtures
- Single Contact Bayonet Base - BA9s
 Double Contact Bayonet Base - BA15d
- Operate in Any Position

Watts	Ushio Ordering Code	Ushio Lamp Code	Dimensions mm			Filament Type	Approx Lumens lm	Color Temp K	Avg Life h	Bulb Finish
			Dia (A)	OAL (B)	LCL (C)					
Single Contact Bayonet Base – BA9s										
5	1000832	JC12V-5W/BA9S	9.0	28.0	15.0	C-2R	80	3000	240	Clear
10	1000810	JC12V-10W/BA9S	9.0	28.0	15.0	C-6	200	—	240	Clear
12	1000858	JC6V-12W/BA9S	8.0	32.0	15.0	C-8	188	2900	250	Clear
20	1000819	JC12V-20W/BA9S	8.0	30.0	13.5	C-6	340	2900	2000	Clear
Double Contact Bayonet Base – BA15d										
125	1000814	JC12V-125WB/BA15D	15.0	49.0	28.8	C-8	1900	2800	1000	Clear

勝特力材料 886-3-5753170
 勝特力电子(上海) 86-21-54151736
 勝特力电子(深圳) 86-755-83298787
[Http://www.100y.com.tw](http://www.100y.com.tw)

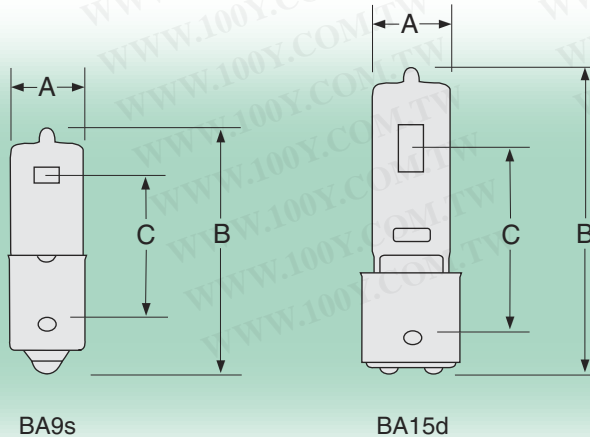

HALOGEN LOW VOLTAGE BI-PIN

JC SERIES

- Only for Use in Approved Enclosed Halogen Fixtures
- Miniature 2-Pin Base - G4
- Operate in Any Position



Watts	Ushio Ordering Code	Ushio Lamp Code	Dimensions mm			Filament Type	Approx Lumens lm	Color Temp K	Avg Life h	Bulb Finish
			Dia (A)	OAL (B)	LCL (C)					
Miniature 2-Pin Base – G4										
3	1000854	JC4V-3W/G4	9.0	28.0	19.5	C-6	35	2868	800	Clear
5	1000874	JC6V-5W/G4	9.0	28.0	19.5	C-6	100	3006	50	Clear
5	1000833	JC12V-5W/G4	9.0	28.0	19.5	C-2R	60	2720	2000	Clear
6	1000876	JC6V-6W/G4	9.0	28.0	19.5	C-6	100	3085	100	Clear
6	1000884	JC9V-6W/G4	9.0	28.0	19.5	C-6	100	2998	50	Clear
8	1000878	JC6V-8W/G4	9.0	28.0	19.5	C-6	163	3168	50	Clear
10	1000856	JC6V-10W/G4	9.0	30.0	19.5	C-6	130	2850	2000	Clear
10	1000857	JC6V-10WH3 (64223)	8.0	31.0	19.5	C-6	150	2900	300	Clear
10	1000531	FHD/ESA, JC6V-10W	9.0	30.0	19.5	C-6	200	3200	100	Clear
10	1000882	JC9V-10W/G4	9.0	28.0	19.5	C-6	230	3078	50	Clear
10	1003030	JC12V-10W/G4	9.0	30.0	19.5	C-6	120	2800	2000	Clear
10	1000811	JC12V-10W/G4	9.0	28.0	19.5	C-2R	140	2900	2000	Clear
10	1000813	JC12V-10WF/G4	9.0	30.0	19.5	C-6	115	2800	2000	Frosted
10	1000812	JC12V-10W/G4	9.0	28.0	19.5	C-2R	175	2916	300	Clear
12	1000815	JC12V-12W/G4	9.0	28.0	19.5	C-6	276	3100	50	Clear
15	1000861	JC6V-15W/G4	9.0	28.0	19.5	C-6	300	3138	100	Clear
20	1000532	FHE/ESB, JC6V-20W	9.0	30.0	19.5	C-6	450	3200	100	Clear
20	1000866	JC6V-20W/G4	9.0	30.0	19.5	C-6	280	2850	2000	Clear
20	1000821	JC12V-20W/G4	9.0	30.0	19.5	C-6	350	2850	2000	Clear
20	1000804	JC12V-20W/G4	9.0	30.0	19.5	C-8	350	2850	2000	Clear
20	1000820	JC12V-20WF/G4	9.0	30.0	19.5	C-6	330	2900	2000	Frosted
20	1000844	JC24V-20W/G4	9.0	30.0	19.5	C-6	280	2850	2000	Clear
30	1000867	JC6V-30W/G4	9.0	30.0	19.25	C-6	800	3300	50	Clear
35	1000825	JC12V-35WB/G4	9.0	30.0	19.5	C-6	650	2900	2000	Clear

Originally developed as light sources for optical instruments, JC lamps feature an overall compact design with precise LCL placement. The exceptional brightness of this compact lamp make this series an ideal choice for task light applications.

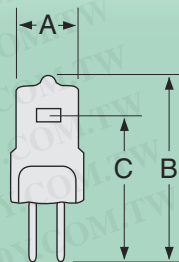

G4

勝特力材料 886-3-5753170
勝特力电子(上海) 86-21-54151736
勝特力电子(深圳) 86-755-83298787
[Http://www.100y.com.tw](http://www.100y.com.tw)

HALOGEN LOW VOLTAGE BI-PIN

JC SERIES

- Only for Use in Approved Enclosed Halogen Fixtures
- Miniature 2-Pin Base - G5.3



Watts	Ushio Ordering Code	Ushio Lamp Code	Dimensions mm			Filament Type	Approx Lumens lm	Color Temp K	Avg Life h	Bulb Finish
			Dia (A)	OAL (B)	LCL (C)					
Miniature 2-Pin Base – G5.3										
30	1000254	DZA, JC10.8V-30W	11.5	51.0	27.0	C-6	600	3100	400	Clear
50	1000837	JC14.5V-50WC	11.5	55.0	32.0	CBar6	1250	3200	100	Clear
65	1000316	ELA, JC19V-65W	11.5	44.5	25.5	CC-6	1900	3350	25	Clear
100	1000649	GCC, JC12V-100WC5	11.5	57.0	32.0	CBar6	2900	3300	200	Clear
100	1000255	DZB, JC12V-100W	11.5	51.0	27.0	CBar6	3100	3400	50	Clear
175	1000330	EML, JC24V-175W	13.5	57.2	27.0	CBar6	5600	3200	125	Clear

勝特力材料 886-3-5753170
 勝特力电子(上海) 86-21-54151736
 勝特力电子(深圳) 86-755-83298787
[Http://www.100y.com.tw](http://www.100y.com.tw)

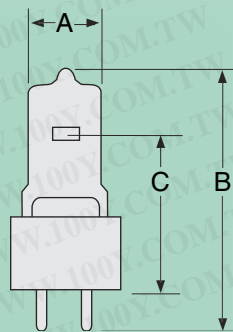

G5.3

HALOGEN LOW VOLTAGE BI-PIN

JC SERIES

- Only for Use in Approved Enclosed Halogen Fixtures
- Glass 2-Pin Base - G6.35
- 2-Pin Base - G.35/15X19

勝特力材料 886-3-5753170
勝特力电子(上海) 86-21-54151736
勝特力电子(深圳) 86-755-83298787
[Http://www.100y.com.tw](http://www.100y.com.tw)

Watts	Ushio Ordering Code	Ushio Lamp Code	Dimensions mm			Filament Type	Approx Lumens lm	Color Temp K	Avg Life h	Burn Position	Bulb Finish	Fig No	
			Dia (A)	OAL (B)	LCL (C)								
Glass 2-Pin Base – G6.35													
20	1000822	JC12V-20W	11.0	44.0	30.0	C-6	280	2850	2000	Any	Clear	1	
30	1000868	JC6V-30WT1	11.5	44.0	28.0	C-6	600	3200	100	Any	Clear	1	
35	1000823	JC12V-35W	11.0	44.0	30.0	C-6	650	2900	2000	Any	Clear	1	
50	1000071	BRL, JC12V-50W	11.5	44.0	30.0	CBar6	1600	3400	50	BD/Hor	Clear	1	
50	1000830	JC12V-50WG1.0	11.0	44.0	30.0	C-6	900	2900	2000	Any	Clear	1	
50	1000829	JC12V-50WF	10.5	44.0	30.0	C-6	840	3000	2000	Any	Frosted	1	
50	1000848	JC24V-50W	10.5	44.0	30.0	C-6	750	2950	2000	Any	Clear	1	
75	1000834	JC12V-75W	11.0	44.0	30.0	C-6	2200	3300	2000	Any	Clear	1	
75	1000836	JC12V-75WG	11.0	44.0	30.0	C-8	1400	3000	2000	Any	Clear	1	
75	1000849	JC24V-75W	10.5	44.0	—	CC-8	—	—	—	Any	Clear	2	
100	1000839	JC24V-100W	11.0	44.0	30.0	CC-6	1800	3000	2000	Any	Clear	1	
150	1000492	FCS, JC24V-150WUI	13.5	50.0	32.0	CBar6	5000	—	50	BD/Hor	Clear	1	
150	1000493	FCS/FR, JC24V-150W/F	13.5	50.0	32.0	CBar6	—	3400	50	BD/Hor	Frosted	1	
150	1000505	FDV, JC24V-150W	13.5	50.0	30.0	CBar6	4300	3300	100	BD/Hor	Clear	1	
150	1000506	FDW, JC24V-150W	13.5	50.0	30.0	CBar6	5000	3400	50	BD/Hor	Clear	1	
150	1000537	FHY, JC24V-150W	13.5	50.0	30.0	CBar6	3700	3100	1000	BD/Hor	Clear	1	
150	1002242	FCS/XE, XE 150W 24V	12.7	50.0	37.0	C-6	6300	3450	40	BD/Hor	Clear	1	
250	1000290	EHJ, JC24V-250W	13.5	55.0	33.0	CBar6	8500	3400	50	BD/Hor	Clear	1	
250	1000382	EVC/FGX, JC24V-250W	13.0	64.0	35.0	CBar6	8400	3400	300	Any	Clear	1	
250	1002243	EHJ/XE, XE 250W 24V	12.7	55.0	33.0	CBar6	10000	3400	50	BD/Hor	Clear	1	
275	1000588	FNT, JC24V-275W	13.5	55.0	33.0	CBar6	10000	3400	75	BD/Hor	Clear	1	
300	1000845	JC24V-300W-H	14.0	55.0	33.0	CBar6	10200	3400	50	BD/Hor	Clear	1	
400	1000383	EVD, JC36V-400WS1	—	16.0	60.0	36.0	CBar6	14500	3450	50	BD/Hor	Clear	1
400	1002244	EVD/XE, XE 400W 36V	16.0	60.0	36.0	CBar6	16000	3400	50	BD/Hor	Clear	1	
400	1002141	EVD/L, JC36V-400H1	17.0	60.0	36.0	CBar6	14500	3400	100	BD/Hor	Clear	1	
2-Pin Base – G6.35/15X19													
150	1000843	JC24V-150WL-H	13.5	61.0	37.0	CBar6	4800	3400	50	BD/Hor	Clear	3	

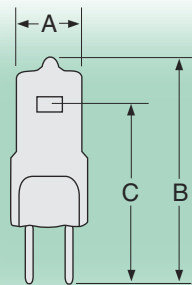

Fig.1

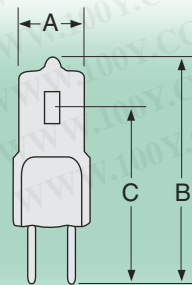

Fig.2

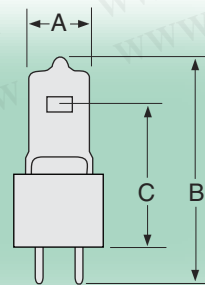

Fig.3



HALOGEN LOW VOLTAGE BI-PIN & BAYONET

JC SERIES

- Only for Use in Approved Enclosed Halogen Fixtures
- Glass 2-Pin Base - GY6.35
- 2-Pin Prefocus Base - GY9.5

勝特力材料 886-3-5753170
勝特力电子(上海) 86-21-54151736
勝特力电子(深圳) 86-755-83298787
[Http://www.100y.com.tw](http://www.100y.com.tw)



Watts	Ushio Ordering Code	Ushio Lamp Code	Dimensions mm			Filament Type	Approx Lumens lm	Color Temp K	Avg Life h	Burn Position	Bulb Finish	Fig No
			Dia (A)	OAL (B)	LCL (C)							
Glass 2-Pin Base – GY6.35												
35	1000824	JC12V-35W	11.0	44.0	30.0	C-8	650	2900	2000	BD/Hor	Clear	1
50	1000827	JC12V-50W	11.0	44.0	30.0	C-6	1000	3000	2000	Any	Clear	2
50	1000828	JC12V-50W	11.0	44.0	30.0	C-8	1000	3000	2000	Any	Clear	2
75	1000835	JC12V-75W	11.0	44.0	30.0	C-6	1600	3000	2000	Any	Clear	2
100	1000806	JC12V-100W	11.0	44.0	30.0	C-6	2300	3000	2000	Any	Clear	2
100	1000807	JC12V-100WG	11.0	44.0	30.0	C-8	2300	3000	2000	Any	Clear	1
100	1000381	EVA, JC12V-100H20	11.5	44.0	30.0	CBar6	2400	3000	2000	BD/Hor	Clear	2
100	1000490	FCR, JC12V-100W	11.0	44.0	30.0	CBar6	3400	3300	50	BD/Hor	Clear	2
100	1000507	FDX, JC12V-100WCG2	11.5	44.0	30.0	CBar6	3500	3300	50	Any	Clear	3
300	1000545	FLW, JC24V-300WA-H	13.5	55.0	33.0	CBar6	10450	3500	50	Any	Clear	3
300	1000846	JC24V-300WB	17.5	55.0	23.0	CBar6	6680	6600	1000	Any	Clear	2
2-Pin Prefocus Base – GY9.5												
20	1003049	JC12V-20W	11.0	55.0	30.3	C-6	300	3000	2000	BD/Hor	Clear	4
80	1000171	DDJ/DZZ, JC10V-80W	11.5	51.0	27.0	CBar6	1700	3150	1000	BD/Hor	Clear	4
100	1000459	EYL, JC12V-100WC4	11.5	62.0	36.5	CBar6	2900	3300	50	BD/Hor	Clear	4
100	1000504	FDT, JC12V-100W	11.5	57.0	27.0	CBar6	2900	3300	50	BD/Hor	Clear	4
132	1000176	DDP, JC22V-132W	13.5	57.0	33.4	CBar6	3900	3250	125	BD/Hor	Clear	4
150	1000503	FDS/DZE, JC24V-150W	14.0	57.2	33.4	CBar6	5000	3400	50	BD/Hor	Clear	4

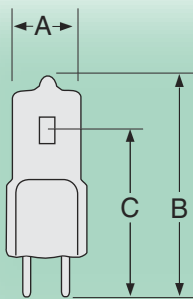

Fig.1

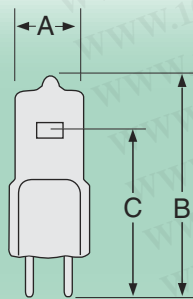

Fig.2

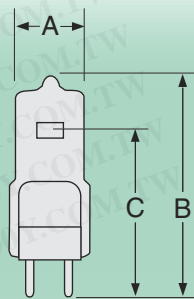

Fig.3

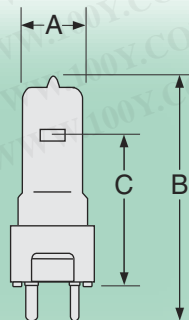

Fig.4

HALOGEN LOW VOLTAGE BI-PIN & BAYONET

JCD SERIES

- Only for Use in Approved Enclosed Halogen Fixtures
- Double Contact Bayonet Base - BA15d



Watts	Ushio Ordering Code	Ushio Lamp Code	Dimensions mm			Filament Type	Approx Lumens lm	Color Temp K	Avg Life h	Burn Position	Bulb Finish
			Dia (A)	OAL (B)	LCL (C)						
Double Contact Bayonet Base – BA15d											
60	1000915	JCD24V-60W	12.5	60.5	35.0	CC-6	1260	—	500	BD/Hor	Clear
75	1000916	JCD24V-75W	11.0	55.0	34.9	CC-6	1600	3100	500	BD/Hor	Clear
75	1000917	JCD28V-75W/WGB	13.5	63.5	35.0	CC-6	1400	2950	2000	BD/Hor	Clear

勝特力材料 886-3-5753170
 勝特力电子(上海) 86-21-54151736
 勝特力电子(深圳) 86-755-83298787
[Http://www.100y.com.tw](http://www.100y.com.tw)

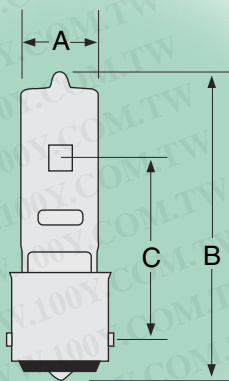
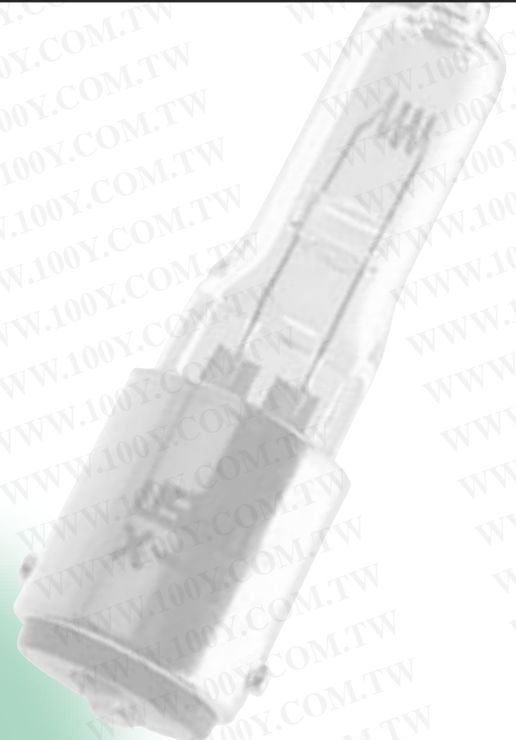

BA15d

HALOGEN BI-PIN SSTV & AV

JCD SERIES

• Only for Use in Approved Enclosed Halogen Fixtures

勝特力材料 886-3-5753170
 勝特力电子(上海) 86-21-54151736
 勝特力电子(深圳) 86-755-83298787
[Http://www.100y.com.tw](http://www.100y.com.tw)

Watts	Ushio Ordering Code	Ushio Lamp Code	Dimensions mm			Filament Type	Approx Lumens lm	Color Temp K	Avg Life h	Burn Position	Bulb Finish	Fig No
			Dia (A)	OAL (B)	LCL (C)							
Miniature 2-Pin Base – G5.3												
200	1000648	GCB, JCD30V-200WC1	11.5	57.0	32.0	CC-6	5300	3200	200	BD/Hor	Clear	1
250	1000453	EYH/FKT, JCD120V-250WB	22.0	63.5	36.5	CC-6	6050	3050	150	BD/Hor	Clear	2
300	1000899	JCD120V-300WCP	22.0	62.0	37.0	CC-6	7350	3200	100	BD/Hor	Clear	2
360	1000442	EYB, JCD82V-360W	11.5	57.0	31.8	CC-8	10000	3300	75	BD/Hor	Clear	1
360	1000443	EYB-5, JCD86V-360WS	11.5	57.0	31.8	CC-8	10000	3300	75	BD/Hor	Clear	1
500	1000476	FBG/FBD, JCD120V-500WCP	22.0	76.0	44.5	CC-6	13200	3200	50	BD/Hor	Clear	2
600	1000246	DYH, JCD120V-600WCP	22.0	63.0	36.5	CC-6	17000	3200	75	BD/Hor	Clear	2
600	1000247	DYJ, JCD230V-650WSP	24.0	63.5	42.9	2CC-8	20000	3400	20	BD/Hor	Clear	3
650	1000225	DVY, JCD120V-650WSP	22.0	63.0	36.5	CC-6	20000	3400	25	BD/Hor	Clear	2
Glass 2-Pin Base – G6.35												
100	1000892	JCD120V-100W/A	13.5	50.0	30.0	CC-6	2000	3000	150	BD/Hor	Clear	4
150	1000920	JCD40V-150WB	13.5	50.0	30.0	CC-6	2800	3950	500	BD/Hor	Clear	5
150	1000371	ESY, JCD100V-150WB	13.5	50.0	33.0	CC-6	3300	3075	200	BD/Hor	Clear	5
150	1000893	JCD120V-150WB	14.0	50.0	30.0	CC-6	3200	3075	100	BD/Hor	Clear	5
150	1003102	JCD220V-150W	—	55.0	36.0	CC-8	—	—	100	—	Clear	6
300	1000216	DRA, JCD120V-300W	16.0	50.0	33.0	CC-6	6900	3100	300	BD/Hor	Clear	4
300	1002253	JCD220V-300W	22.0	65.0	37.0	2CC-8	7200	3150	50	BD/Hor	Clear	5
2-Pin Base – G6.35/15x19												
300	1000897	JCD120V-300WC/LP	22.0	62.0	37.0	CC-6	7500	3200	70	BD/Hor	Clear	7
300	1000900	JCD120V-300WL	22.0	63.0	37.0	CC-6	7500	3200	150	BD/Hor	Clear	7
500	1000904	JCD120V-500WL	22.0	63.5	36.5	CC-6	13000	3200	100	BD/Hor	Clear	7
650	1000890	JCD100V-650WL	22.0	63.0	37.0	CC-6	17750	3200	150	BD/Hor	Clear	7
650	1000907	JCD120V-650WL	22.0	63.0	37.0	CC-6	17750	3200	150	BD/Hor	Clear	7
2-Pin Base – GX6.35												
300	1001762	JCD120V-300W (ref. 64514)	19.5	57.5	37.0	Special	7700	3200	75	BD/Hor	Clear	5

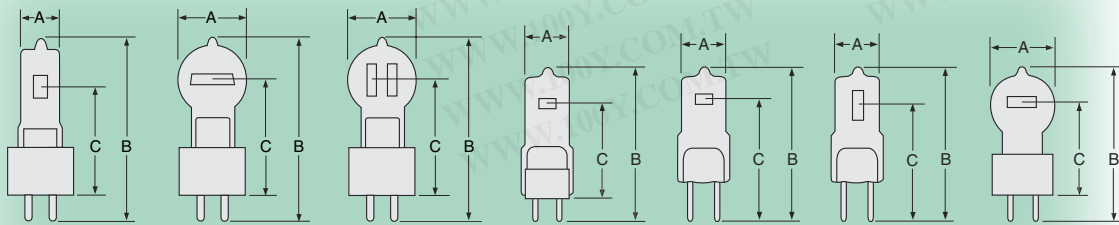

Fig.1

Fig.2

Fig.3

Fig.4

Fig.5

Fig.6

Fig.7

HALOGEN BI-PIN SSTV & AV

JCD SERIES

- Only for Use in Approved Enclosed Halogen Fixtures
- Clear Bulb Finish
- 2-Pin Base - GY6.35
- 2 Button Base - G9.5
- Medium Prefocus 2-Pin Base - GY9.5

勝特力材料 886-3-5753170
勝特力电子(上海) 86-21-54151736
勝特力电子(深圳) 86-755-83298787
[Http://www.100y.com.tw](http://www.100y.com.tw)

Watts	Ushio Ordering Code	Ushio Lamp Code	Dimensions mm			Filament Type	Approx Lumens lm	Color Temp K	Avg Life h	Burn Position	Fig No
			Dia (A)	OAL (B)	LCL (C)						
2-Pin Base – GY6.35											
35	1000902	JCD120V-35W	11.0	55.0	38.0	CC-2V	500	2800	1500	BD/Hor	1
50	1000905	JCD120V-50W	11.0	55.0	38.0	CC-2V	700	2800	1500	BD/Hor	1
75	1000908	JCD120V-75W	11.5	55.0	38.0	CC-8	1100	2850	1500	BD/Hor	2
2 Button Base – G9.5											
600	1000248	DYP, JCD120V-600WM	22.0	60.0	21.9	CC-6	17000	3200	75	BD/Hor	3
1000	1000891	JCD120V-1000WC	32.0	95.0	62.0	CC-6	25000	3200	200	BD/Hor	3
Medium Prefocus 2-Pin Base – GY9.5											
150	1000309	EKL, JCD21V-150W	11.5	51.0	27.0	CC-6	4650	3350	40	BD/Hor	4
250	1000245	DYG, JCD30V-250WS	19.9	63.5	36.5	CC-6	8000	3400	15	BD/Hor	4
300	1000886	JCD100V-300WC	22.0	63.0	36.5	CC-6	7500	3200	150	BD/Hor	5
420	1000304	EKB, JCD120V-420WC	22.0	63.0	36.5	CC-6	11000	3200	75	BD/Hor	5
500	1000629	FTK, JCD120V-500WCT	22.0	65.3	36.5	CC-6	13500	3100	200	BD/Hor	4
500	1000914	JCD240V-500WC	24.0	62.0	36.5	2CC-8	12500	3200	50	BD/Hor	6
600	1000251	DYS/DYV/BHC, JCD120V-600WC	22.0	63.0	36.5	CC-6	17000	3200	75	BD/Hor	5
600	1000252	DYS-5, JCD125V-600WC	22.0	63.0	36.5	CC-6	13750	3200	75	BD/Hor	5
650	1000305	EKD, JCD120V-650WS	19.9	66.0	36.5	CC-6	20000	3400	25	BD/Hor	5
650	1000249	DYR/220V, JCD220V-650WC1	24.0	63.0	36.5	2CC-8	16500	3200	50	BD/Hor	6
650	1000250	DYR/240V, JCD240V-650WC2	24.0	63.0	36.5	2CC-8	16500	3200	50	BD/Hor	6
800	1000909	JCD120V-800WC	24.0	62.0	36.5	CC-6	19500	3200	75	BD/Hor	5

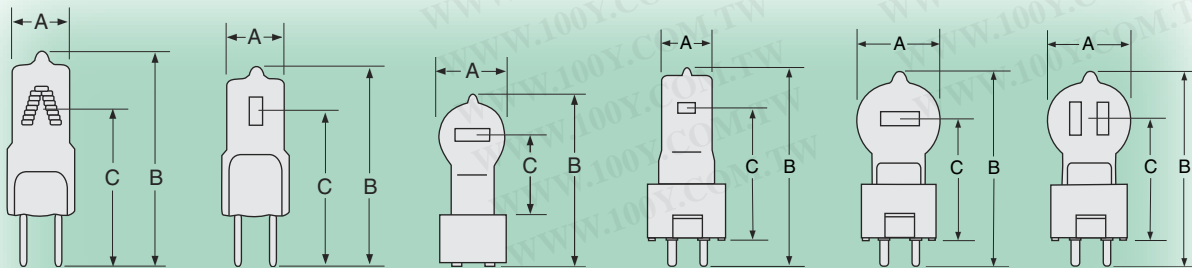

Fig.1

Fig.2

Fig.3

Fig.4

Fig.5

Fig.6

HALOGEN BI-PIN • SSTV

JCD - JCP SERIES

- Only for Use in Approved Enclosed Halogen Fixtures
- Medium Prefocus 2-Pin Base - GY9.5/15x19
GY9.5/16X21, GY9.5/16X24 & G22 Base

勝特力材料 886-3-5753170
 勝特力电子(上海) 86-21-54151736
 勝特力电子(深圳) 86-755-83298787
[Http://www.100y.com.tw](http://www.100y.com.tw)

Watts	Ushio Ordering Code	Ushio Lamp Code	Dimensions mm			Filament Type	Approx Lumens lm	Color Temp K	Avg Life h	Burn Position	Fig No
			Dia (A)	OAL (B)	LCL (C)						
Medium Prefocus 2-Pin Base – GY9.5/15x19											
300	1000896	JCD120V-300WC	22.0	63.5	36.5	CC-6	7500	3200	100	BD/Hor	1
Medium Prefocus 2-Pin Base – GY9.5/16x21											
300	1000912	JCD230V-300WC	24.0	63.5	36.5	2CC-8	7050	3150	75	BD/Hor	2
500	1000903	JCD120V-500WC	22.0	62.0	36.5	CC-6	13000	3200	100	BD/Hor	1
650	1000889	JCD100V-650WC	22.0	63.0	36.5	CC-6	17750	3200	150	BD/Hor	1
650	1000906	JCD120V-650WC	22.0	63.0	36.5	CC-6	17750	3200	75	BD/Hor	1
GY9.5/16X24 Base											
650	1002110	JCP100V-650WCC	19.5	76.0	36.5	C-13D	18750	3300	75	BD/Hor	3
G22 Base											
2000	1000894	JCD120V-2000WC	40.0	170	105	CC-6	56000	3200	200	BD/Hor	4
2000	1000910	JCD220V-2000WC	40.0	165	100	2CC-8	50000	3200	200	BD/Hor	5

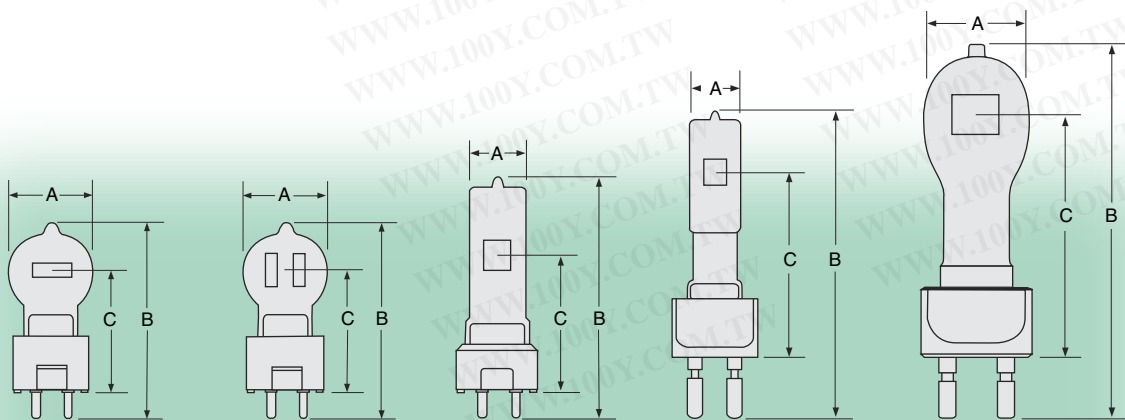

Fig.1

Fig.2

Fig.3

Fig.4

Fig.5

HALOGEN BI-PIN • SSTV

JCS SERIES

- Only for Use in Approved Enclosed Halogen Fixtures
- 4-Pin Base
- Standard Voltage (120 volts)
- Monoplane Filament

Watts	Ushio Ordering Code	Ushio Lamp Code	Dimensions mm			Filament Type	Approx Lumens lm	Color Temp K	Avg Life h	Burn Position	Fig No
			Dia (A)	OAL (B)	LCL (C)						
4-Pin Base – G17T-7											
500	1000345	EPR, JCS120V-500W	19.5	89.0	41.0	C-13D ○	—	3250	50	BD/Hor	1
1200	1000072	BRN, JCS120V-1200W	23.0	95.0	38.7	C-13D ○	—	3350	20	BD/Hor	2
1200	1000082	BTG, JCS120V-1200W	23.0	95.0	39.7	C-13D ○	38200	3350	20	BD	2

○ Proximity Reflector

勝特力材料 886-3-5753170
 勝特力电子(上海) 86-21-54151736
 勝特力电子(深圳) 86-755-83298787
[Http://www.100y.com.tw](http://www.100y.com.tw)

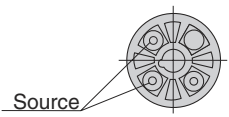
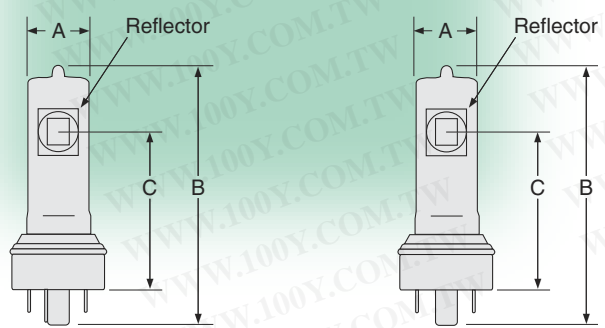

Fig.1

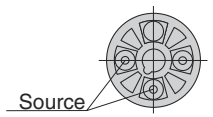

Fig.2

HALOGEN BI-PIN • SSTV

JCS SERIES

• Only for Use in Approved Enclosed Halogen Fixtures

勝特力材料 886-3-5753170
 勝特力电子(上海) 86-21-54151736
 勝特力电子(深圳) 86-755-83298787
[Http://www.100y.com.tw](http://www.100y.com.tw)

Watts	Ushio Ordering Code	Ushio Lamp Code	Dimensions mm			Filament Type	Approx Lumens lm	Color Temp K	Avg Life h	Burn Position	Fig No
			Dia (A)	OAL (B)	LCL (C)						
Medium 2-Pin Base – G9.5											
575	1003229	GLA/HP-601, JCS115V-575WX	20.0	101.6	60.0	C-13D	12500	3100	1500	Any	1
600	1000665	GLC/HP-600, JCS115V-600WCM	20.0	101.6	60.0	C-13D	15600	3200	300	Any	1
750	1000097	BWM, JCS120V-750WC1	22.0	114.3	60.3	C-13D	21000	3200	200	BD/Hor	1
1000	1000098	BWN, JCS120V-1000WC1	22.0	114.3	60.3	C-13D	28500	3200	250	BD/Hor	1
Medium Prefocus 2-Pin Base – GX9.5											
1000	1000948	JCS120V-1000WCGXW (CP24)	36.0	110.0	55.0	C-13D	26000	3200	200	Any	2
Medium Prefocus 2-Pin Base – GY9.5											
300	1000540	FKW, JCS120V-300WC/UA	23.0	90.4	46.5	C-13	7800	3200	200	Any	3
300	1000954	JCS220/230V-300WC	23.0	90.0	46.5	C-13D	6600	3050	150	Any	3
500	1000285	EHA, JCS120V-500W	19.5	76.0	36.5	C-13D	—	3200	75	BD/Hor	4
500	1000603	FRG, JCS120V-500WC1	23.0	90.4	46.5	C-13D ○	13000	3200	150	Any	3
575	1003326	JCS120V-575WC	25.0	90.0	46.5	8-C-13D	15500	3200	300	BD	3
575	1003327	JCS120V-575WX	25.0	90.0	46.5	8-C-13D	12000	3200	1500	BD	3
625	1000089	BVE, JCS120V-625W	19.5	89.0	44.5	C-13D	—	3350	75	BD/Hor	4
625	1002229	BVE-5, JCS125V-625W	19.5	89.0	44.5	C-13D	—	3200	75	BD/Hor	4
650	1000604	FRK, JCS120V-650WC/UA	22.5	90.4	46.5	C-13D ○	17500	3200	200	Any	3
900	1000088	BVA, JCS120V-900W	23.0	95.0	44.5	C-13D	—	3300	75	BD/Hor	3
Medium Prefocus 2-Pin Base – GY9.5 / 16x24											
650	1000947	JCS100V-650WCC	19.0	72.0	36.5	C-13D ○	17000	3200	100	BD/Hor	5
1200	1001787	JCS120V-1200WC	23.0	89.0	46.5	C-13D	33600	3300	75	BD/Hor	3

○ Proximity Reflector

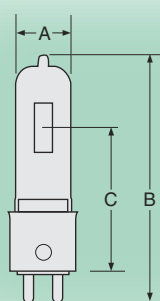
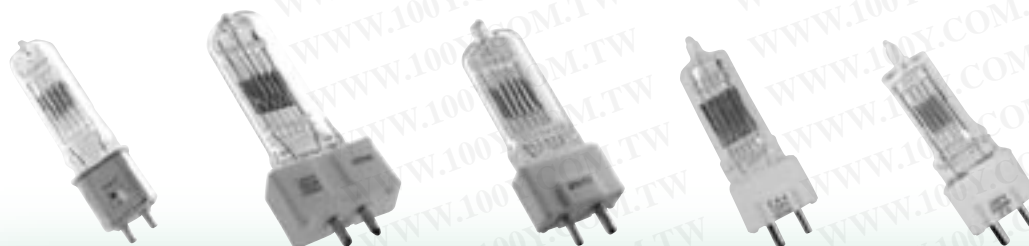

Fig.1

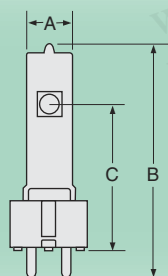

Fig.2

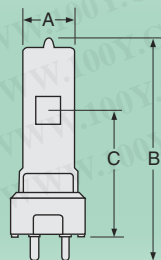

Fig.3

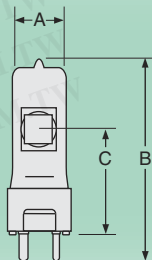

Fig.4

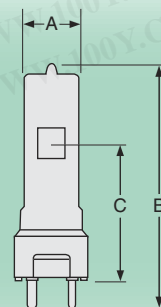

Fig.5

HALOGEN PREFOCUS BAYONET • SSTV

JCS SERIES

- Only for Use in Approved Enclosed Halogen Fixtures
- Medium Prefocus Base - P28s
- Mogul Prefocus Base - P40s
- 120 Volts

勝特力材料 886-3-5753170
 勝特力电子(上海) 86-21-54151736
 勝特力电子(深圳) 86-755-83298787
[Http://www.100y.com.tw](http://www.100y.com.tw)



Watts	Ushio Ordering Code	Ushio Lamp Code	Dimensions mm			Filament Type	Approx Lumens lm	Color Temp K	Avg Life h	Burn Position	Fig No
			Dia (A)	OAL (B)	LCL (C)						
Medium Prefocus Base – P28s											
500	1000083	BTL, JCS120V-500WBP28	19.5	127.0	55.5	C-13D	11000	3050	500	BD/Hor	1
500	1000084	BTM, JCS120V-500WCP28	19.5	127.0	55.5	C-13D	13000	3200	100	BD/Hor	1
500	1000208	FMC/DNS, JCS120V-500WB2P28	19.5	156.0	88.9	C-13D	11000	3050	500	Any	2
750	1000085	BTN, JCS120V-750WBP28	23.0	127.0	55.5	C-13D	17000	3050	500	BD/Hor	1
750	1000086	BTP, JCS120V-750WCP28	23.0	127.0	55.5	C-13D	20000	3200	200	BD/Hor	1
750	1000209	FMD/DNT, JCS120V-750WB2P28	23.0	156.0	88.9	C-13D	17000	3050	500	Any	2
1000	1000087	BTR, JCS120V-1000WCP28	23.0	127.0	55.5	C-13D	28500	3200	250	BD/Hor	1
1000	1000210	FME/DNV, JCS120V-1000WC2P28	23.0	156.0	88.9	C-13D	27500	3200	200	Any	2
Mogul Prefocus Base – P40s											
1000	1000091	BVT, JCS120V-1000WBP40	23.0	178.0	100.0	C-13D	23000	3050	500	Any	3
1000	1000092	BVV, JCS120V-1000WCP40	23.0	178.0	100.0	C-13D	27500	3200	200	Any	3
1000	1000214	DPW, JCS120V-1000W	64.0	241.3	87.3	C-13	2800	3200	50	BD	6
1500	1000145	CWZ, JCS120V-1500W	35.0	190.0	100.0	C-13D	38500	3200	325	Any	4
1500	1000220	DTA, JCS120V-1500WCP40	25.0	203.0	87.3	C-13D	39000	3200	100	BD	5
2000	1000093	BVW, JCS120V-2000WCP40	35.0	203.2	100.0	C-13	57500	3200	300	Any	5

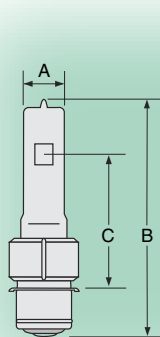

Fig.1

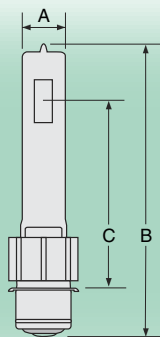

Fig.2

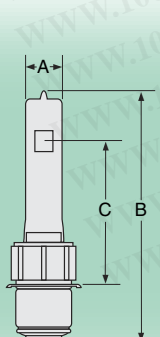

Fig.3

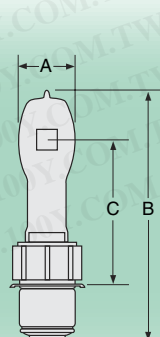

Fig.4

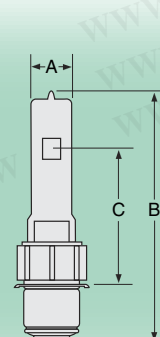

Fig.5

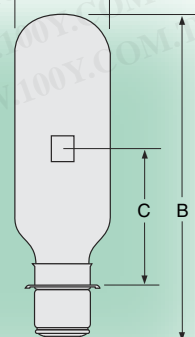

Fig.6

TUNGSTEN HALOGEN LAMPS • SINGLE ENDED BAYONET

JCV SERIES

- Only for Use in Approved Enclosed Halogen Fixtures
- Double Contact Bayonet Base - BA15d
- Operate in any position
- 120 Volts (except as noted)

勝特力材料 886-3-5753170
勝特力电子(上海) 86-21-54151736
勝特力电子(深圳) 86-755-83298787
[Http://www.100y.com.tw](http://www.100y.com.tw)

Watts	Ushio Ordering Code	Ushio Lamp Code	Dimensions mm			Filament Type	Approx Lumens lm	Color Temp K	Avg Life h	Bulb Finish
			Dia (A)	OAL (B)	LCL (C)					
Double Contact Bayonet Base – BA15d										
75	1000986	JCV120V-75WGB	35.0	59.0	35.0	CC-8	1200	2800	1000	Clear
75	1000987	JCV120V-75WGBF	14.0	72.0	35.0	CC-8	1125	2850	1000	Frosted
100	1000968	JCV120V-100WGB	13.0	62.0	35.0	CC-8	1600	2800	2000	Clear
100	1000969	JCV120V-100WGBF	13.0	62.0	35.0	CC-8	1550	2800	2000	Frosted
100	1000364	ESR, JCV120V-100WGB2	13.0	62.0	35.0	CC-2V	1800	2850	750	Clear
100	1000374	ETD, JCV120V-100WGB2F	13.0	62.0	35.0	CC-2V	1750	2850	750	Frosted
150	1000373	ETC, JCV120V-150WGB	13.0	62.0	35.0	CC-8	2800	2900	2000	Clear
150	1000362	ESP, JCV120V-150WGB2	13.0	62.0	35.0	CC-2V	2800	2900	1000	Clear
150	1000376	ETF, JCV120V-150WGBF	13.0	62.0	35.0	CC-8	2700	2900	2000	Frosted
200	1000512	FEV, JCV120V-200WCB2	13.0	62.0	35.0	CC-2V	5500	3200	50	Clear
200	1001803	JCV230V-200WGB	15.0	63.0	35.1	CC-8	5000	2800	2000	Clear
250	1000365	ESS, JCV120V-250WGB	13.0	76.0	41.0	CC-8	5000	3000	2000	Clear
250	1000372	ETB, JCV120V-250WGBF	13.0	76.0	41.0	CC-8	4800	3000	2000	Frosted
250	1000990	JCV130V-250WGBF	13.0	76.0	41.0	CC-8	4800	3000	2000	Frosted
500	1000979	JCV120V-500WGB	13.0	87.0	54.0	CC-8	10450	2950	2000	Clear
500	1000980	JCV120V-500WGBF	13.0	87.0	54.0	CC-8	10100	2950	2000	Frosted

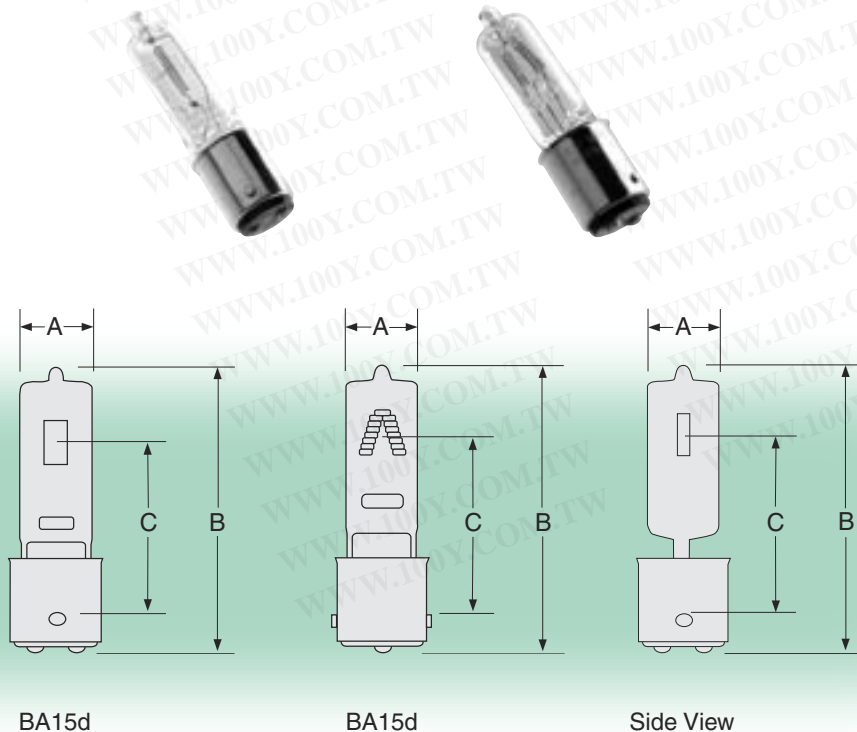

TUNGSTEN HALOGEN LAMPS • SINGLE ENDED SCREW BASE

JCV SERIES

- Only for Use in Approved Enclosed Halogen Fixtures
- Miniature Screw Base - E10 & Minican Screw Base - E11
- Operate in any position
- 120 Volts (except as noted)

勝特力材料 886-3-5753170
勝特力电子(上海) 86-21-54151736
勝特力电子(深圳) 86-755-83298787
[Http://www.100y.com.tw](http://www.100y.com.tw)

Watts	Ushio Ordering Code	Ushio Lamp Code	Dimensions mm			Filament Type	Approx Lumens lm	Color Temp K	Avg Life h	Bulb Finish
			Dia (A)	OAL (B)	LCL (C)					
Miniature Screw Base – E10										
150	1000479	FBT, JCV30V-150WS	11.5	60.0	27.5	CC-8	5000	3400	6	Clear
250	1000480	FBV, JCV30V-250WS	11.5	60.0	27.5	CC-8	7850	3400	6	Clear
350	1000481	FBW, JCV30V-350WS	13.5	60.0	27.5	CC-8	10500	3400	6	Clear
Mini Candelabra Base – E11										
75	1000989	JCV120V-75WGSNF	12.0	65.0	32.0	CC-8	1170	2850	1000	Frosted
75	1000988	JCV120V-75WGSN	12.0	69.0	32.0	CC-8	1125	2800	1000	Clear
100	1000970	JCV120V-100WGSN	14.0	69.0	32.0	CC-8	1600	2850	1000	Clear
100	1000971	JCV120V-100WGSNF	14.0	69.0	32.0	CC-8	1550	2800	2000	Frosted
100	1000361	ESN, JCV120V-100WGSN2	13.0	71.0	35.0	CC-2V	1800	2850	750	Clear
100	1000375	ETE, JCV120V-100WGSN2F	13.0	71.0	35.0	CC-2V	1750	2850	750	Frosted
150	1000377	ETG, JCV120V-150WGSN	13.0	71.0	35.0	CC-8	2800	2900	2000	Clear
150	1000378	ETH, JCV120V-150WGSNF	13.0	71.0	35.0	CC-8	2700	2900	2000	Frosted
150	1000359	ESL, JCV120V-150WGSN2	13.0	71.0	35.0	CC-2V	2800	2900	1000	Clear
150	1000992	JCV220/230V-150WMF	16.5	75.0	56.0	CC-2V	2300	2900	1500	Frosted
200	1001800	JCV100V-200WGS	14.0	69.0	32.0	CC-8	2900	2900	3000	Clear
250	1000294	EHT, JCV120V-250WGSN	13.5	80.0	41.3	CC-8	5000	3000	2000	Clear
250	1000360	ESM, JCV120V-250WGSNF	13.0	80.0	41.0	CC-8	4800	3000	2000	Frosted
250	1000991	JCV130V-250WGSN	13.0	80.0	41.0	CC-8	5000	3000	2000	Clear
250	1001809	JCV130V-250WGSNF	13.0	80.0	41.0	CC-8	4850	3000	2000	Frosted
250	1000993	JCV220/230V-250WMF	15.0	75.0	—	CC-2V	4500	2900	2000	Frosted
300	1000961	JCV100V-300WGS	15.0	78.0	42.0	CC-8	4650	2850	3000	Clear
300	1001813	JCV120V-300WGS	15.0	78.0	42.0	CC-8	4650	2950	1500	Clear

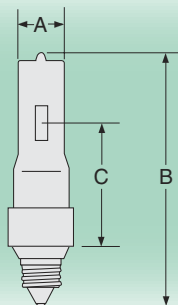

E10

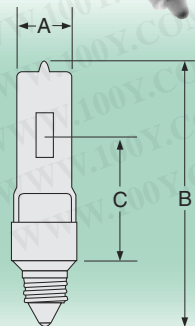

E11

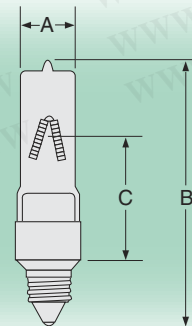

E11