

SWITCHES & CONTROL GEAR

指撥開關
指撥開關

Switches(In-LineSwitches)

詳細產品規格--請點擊www.100y.com.tw

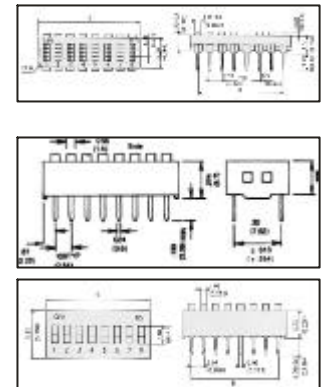
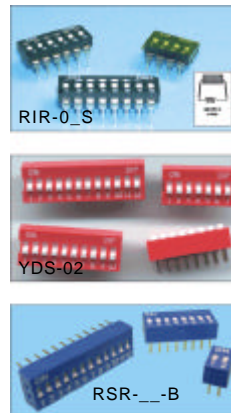
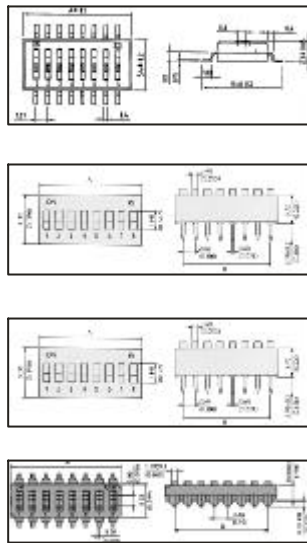
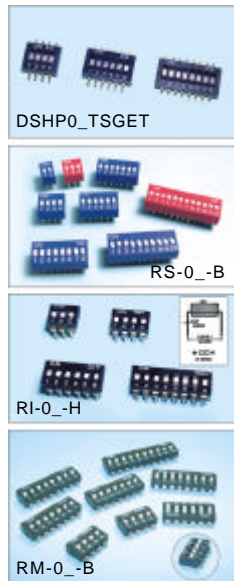

詳細產品規格--請點擊www.100y.com.tw

PartNo.	ProductNo.	Manuf.	Description	No.ofposition
12988	DSHP04TSGET		SMD型-指撥開關	4-P
12989	DSHP06TSGET		SMD型-指撥開關	6-P
12990	DSHP08TSGET		SMD型-指撥開關	8-P
17515	RI-04-H		IC型指撥開關	4-P
17516	RI-06-H		IC型指撥開關	6-P
17517	RI-08-H		IC型指撥開關	8-P
3594	RIR-03-S		IC型指撥開關	3-P
3595	RIR-04-S		IC型指撥開關	4-P
3596	RIR-06-S		IC型指撥開關	6-P
3597	RIR-08-S		IC型指撥開關	8-P
17248	RM-04	RESON	SURFACE MOUNTING TYPE DIP SWITCH	4P
18694	RM-05	RESON	SURFACE MOUNTING TYPE DIP SWITCH	5P
17249	RM-06	RESON	SURFACE MOUNTING TYPE DIP SWITCH	6P
17250	RM-07	RESON	SURFACE MOUNTING TYPE DIP SWITCH	7P
17251	RM-08	RESON	SURFACE MOUNTING TYPE DIP SWITCH	8P
17252	RM-10		SURFACEMOUNTING TYPEDIP SWITCH	10P
22095	RS-01-B		DIP 指撥開關	01-P
3599	RS-02-B		DIP 指撥開關	2-P
3598	RS-03-B		DIP 指撥開關	3-P
3600	RS-04-B		DIP 指撥開關	4-P
22096	RS-05-B		DIP 指撥開關	05-P
6792	RS-06-B		DIP 指撥開關	6-P
6793	RS-07-B		DIP 指撥開關	7-P
3601	RS-08-B		DIP 指撥開關	8-P
22097	RS-09-B		DIP 指撥開關	09-P
6794	RS-10-B		DIP 指撥開關	10-P
4492	RS-12-B		DIP 指撥開關	12-P
19486	RSR-02-B			
19487	RSR-08-B			
19488	RSR-12-B			
3386	YDS-02		DIP 指撥開關	2P

DIP 側撥式指撥開關 Piano Type DIP Switches(In-Line Switches)

詳細產品規格--請點擊www.100y.com.tw



SWITCHES & CONTROL GEAR

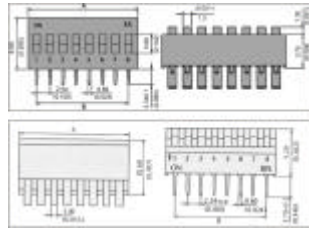
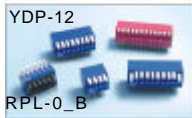

PartNo.	ProductNo.	Description	No.ofposition
12400	RA-04-B	指撥開關 0°	4-P
12401	RA-06-B	指撥開關 0°	6-P
12402	RA-08-B	指撥開關 0°	8-P
22093	RPL-03B	3P側撥式指撥開關	3P
3384	RPL-04B	4P側撥式指撥開關	4P
22094	RPL-05B	5P側撥式指撥開關	5P
2199	RPL-06B	6P側撥式指撥開關	6P
6819	RPL-08B	8P側撥式指撥開關	8P
2201	RPL-10B	10P側撥式指撥開關	10P
2202	YDP-12	12P側撥式指撥開關	12P

DIP 型旋轉選擇開關 Rotary DIP Switches



PartNo.	ProductNo.	Description	Position
10747	900A-R2-T1-M1-112	SMD旋轉選擇開關	6P
10746	900A-R2-T1-M2-14	SMD旋轉選擇開關	6P
5679	900A-R2B-T112	SMD旋轉選擇開關	6P
12933	DRS4010	SMD旋轉選擇開關	5-P
13673	DRS4110	SMD旋轉選擇開關	5-P
21768	Y900A-R1T21212	DIP旋轉選擇開關	0-9
21769	Y900A-R1T21412	DIP旋轉選擇開關	0-9,A-F

腳踏開關 Foot Switches

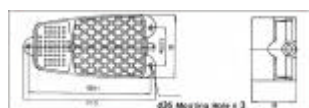
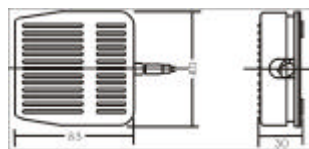

詳細產品規格--請點擊www.100y.com.tw

Part No.	ProductNo.	Description	ContactRating	ContactType
12892	TFS-105	腳踏開關	250Vac/6A	OFF/ON
7565	TFS-201	腳踏開關	250Vac/10A	OFF/ON
17838	TFS-201-2	腳踏開關	250Vac/10A	OFF/ON

小鍵盤 小鍵盤 Keypads

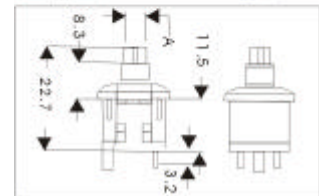
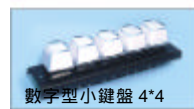
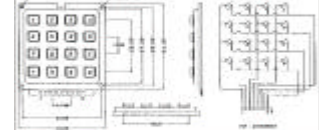
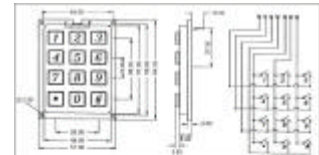

Part No.	ProductNo.	Description
12944	5*1-KEY-SW 鍵盤	5*1 KEY-SW 鍵盤(透明類似電腦鍵盤)
12950	數字型小鍵盤 4*3	數字型小鍵盤 4*3 (電話鍵)
3873	數字型小鍵盤 4*4	數字型小鍵盤 (電話鍵)

鑰匙開關 鑰匙開關 Keylock Switch

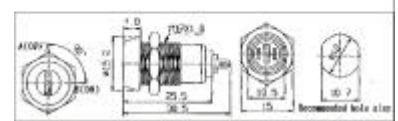
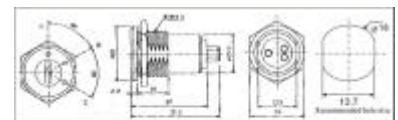

Part No.	ProductNo.	Description	固定孔徑	Color
22299	01K-CA40.Q1P*V2	2P V型交替圓形鑰匙開關	16mm	黑色
22310	01K-SA40.01P*V2	2P V型交替方形鑰匙開關	16mm	黑色
6882	5055	2P 鑰匙長/SW		
13950	5058A	2P 電腦用鑰匙SW	16mm	

電路板用按鍵開關 + 帽蓋 DIP 微型按鍵開關 Miniature PCB-Key Switch

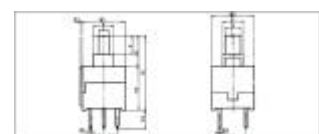

詳細產品規格--請點擊www.100y.com.tw



SWITCHES & CONTROL GEAR



PartNo	ProductNo.	Description	ContactRating	ContactType	Pins
21819	7AD7P2B1M1GE	微小型按鍵	1A/120VAC	O N-MOM(DPDT)	6P
21818	7AS7P2B1M1GE	微小型按鍵	1A/120VAC	O N-MOM(SPDT)	3P
21823	8AD9P1B4M6RE	微小型按鍵	0.4VA	O FF-MOM(SPDT)	4P
21825	8AS8P1B4M6RE	微小型按鍵	0.4VA	O FF-MOM(SPDT)	3P
21822	8AS9P1B4M6RE	防水搖臂開關	0.4VA	O FF-MOM(SPDT)	4P
18417	JB-15LRP2/AT-4060-R	低背照光型開關	50mA/24Vdc	O FF(ON) SPST	6P
4241	KPA-2201B	按鍵開關	16VDC 0.5A	O N-ON(2P2T)有段	6P
8078	KPA-2202A	無段壓動開關	AC125V/0.5A	O N-ON(2P2T)無段	6P
8400	KPA-2202B	按鍵 8*8 有段	AC125V/0.5A	O N-ON(2P2T)有段	6P
6667	KPT-1104A	DIP 按鍵開關	12Vdc ,50mA	O FF-ON無段	4P
11146	KPT-1105G	小型按鍵開關	12Vdc ,50mA	O FF-ON無段	4P
3469	KPT-2203	小型按鍵開關 7*7mm	12Vdc/0.1A	O N-ON(2P2T)有段	6P
14909	LP-12-Y	Illuminated Tact Switches(黃色)	50Ma/12VDC Voltage 6V Max 20mA Max	SPST	6P
17610	TS-6601VA	小型按鍵開關	12Vdc ,50mA	O FF-ON無段	4P
23540	TS-6601VD	小型按鍵開關	12Vdc ,50mA	O FF-ON無段	2P
12033	TS2201T-160g	按鍵開關	12Vdc/50mA	O FF-ON	4P
28384	TS6601H-160g	小型按鍵開關	12Vdc/50mA	O FF-ON無段	4P
22478	TS6601HA-160g	小型按鍵開關	12Vdc/50mA	O FF-ON無段	4P
22814	TS6601HB-160g	小型按鍵開關	12Vdc/50mA	O FF-ON無段	4P
22815	TS6601HC-160g	小型按鍵開關	12Vdc/50mA	O FF-ON無段	4P
22279	TS6601T-160g	Tact Switches	DC12V/50mA	O FF-ON無段	4P
18102	YLP12-GC02	Illuminated Tact Switches	12Vdc/50mA	12*12mm 方框 綠面 綠 LED	6P
18104	YLP12-RC02	Illuminated Tact Switches	12Vdc/50mA	12*12mm 方框 紅面 紅 LED	6P
18103	YLP12-YC02	Illuminated Tact Switches	12Vdc/50mA	12*12mm 方框 黃面 黃 LED	6P
18094	YLP13-A-5-A-532	Illuminated Tact Switches	12Vdc/50mA	10*10mm 灰方框 灰面	4P
18095	YLP13-A-5-B1-132	Illuminated Tact Switches	12Vdc/50mA	10*10mm 灰方框 紅面 紅 LED	6P
18096	YLP13-A-5-B2-232	Illuminated Tact Switches	12Vdc/50mA	10*10mm 灰方框 綠面 綠 LED	6P
18097	YLP13-A-5-B3-332	Illuminated Tact Switches	12Vdc/50mA	10*10mm 灰方框 橘面 橘 LED	6P
18100	YLP13-B-5-A1-132	Illuminated Tact Switches	12Vdc/50mA	10*10mm 灰圓框 紅面 紅 LED	6P
18098	YLP13-B-5-C532	Illuminated Tact Switches	12Vdc/50mA	10*10mm 灰圓框 灰面	4P
18099	YLP13-B-5-D2-232	Illuminated Tact Switches	12Vdc/50mA	10*10mm 灰圓框 綠面 綠 LED	6P
18101	YLP13-B5-D3-332	Illuminated Tact Switches	12Vdc/50mA	10*10mm 灰圓框 橘面 橘 LED	6P
7911	YR18-801-1	白色開關	25mAmsx. @50VAC or DC max.	O FF-MOM	2P
10613	YR18-801-2	黑色開關	25mAmsx. @50VAC or DC max.	O FF-MOM	2P
7913	YR18-801-3	紅色開關	25mAmsx. @50VAC or DC max.	O FF-MOM	2P
7912	YR18-801-5	黃色開關	25mAmsx. @50VAC or DC max.	O FF-MOM	2P
2198	YR18-801-6	綠色開關	25mAmsx. @50VAC or DC max.	O FF-MOM	2P
8539	YR18-801-7	藍色開關	25mAmsx. @50V AC or DC max.	O FF-MOM	2P
18085	YSP86-A0-SCC02	DIP Pushbutton Switches	50mA 24Vdc	小透明蓋	4P
18092	YSP86-A1-3-3C02	DIP Pushbutton Switches	50mA 24Vdc	綠色小蓋帶綠LED	6P
18088	YSP86-A1-SC1C02	DIP Pushbutton Switches	50mA 24Vdc	透明小蓋帶單紅LED	6P
18091	YSP86-A2-332C02	DIP Pushbutton Switches	50mA 24Vdc	綠色小蓋帶綠、黃LED	8P
18090	YSP86-A2-SC13C02	DIP Pushbutton Switches	50mA 24Vdc	透明小蓋帶紅、綠LED	8P
18087	YSP86-B0-SCC02	DIP Pushbutton Switches	50mA 24Vdc	大透明蓋	4P
18089	YSP86-B1-SC1C02	DIP Pushbutton Switches	50mA 24Vdc	透明大蓋帶單紅LED	6P
27943	YSP86-B2-SC1C02	DIP Pushbutton Switches	50mA 24Vdc	透明大蓋帶雙紅綠LED	8P



SWITCHES & CONTROL GEAR

DIP 超微型按鍵開關
Ultra-Miniature, Washable

詳細產品規格--請點擊www.100y.com.tw

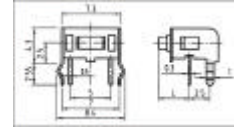

PartNo.	ProductNo.	Description	Pins	Type	ButtonColor	ContactRating
23538	TS6301HA	微型按鍵	2	White	OFF-ON無段	12Vdc/50mA
8344	TS6301V180G	DIP微型按鍵90°	2	White	OFF-ON無段	12Vdc/50mA

SMD 超微型按鍵開關
SMD Ultra-Miniature PushButton Switches

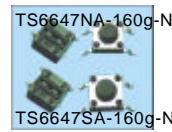

PartNo.	ProductNo.	Manuf.	Description	Pins	Type	ButtonColor	ContactRating
12032	TS4417-180g		SMD小型開關	4	Black	OFF-ON	12Vdc/50mA
8360	TS6301E180G		SMD微型按鍵開關	2	White	OFF-ON無段	12Vdc/50mA
27103	TS6301E180G		SMD微型按鍵開關	2	White	OFF-ON無段	12Vdc/50mA
23421	TS6647NA-160g-N	Kingtek	SMD 按鍵開關	4	黑色	OFF-ON無段	12Vdc/50mA
23422	TS6647SA-160g-N	Kingtek	SMD 按鍵開關	4	黑色	OFF-ON無段	12Vdc/50mA

工業面板式按鍵開關 + 帽蓋
大型旋入面板式按鍵開關
Panel Mounting

詳細產品規格--請點擊www.100y.com.tw

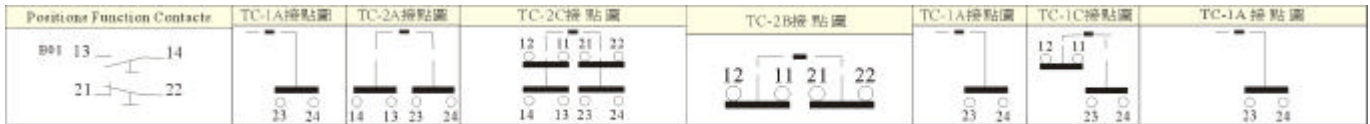
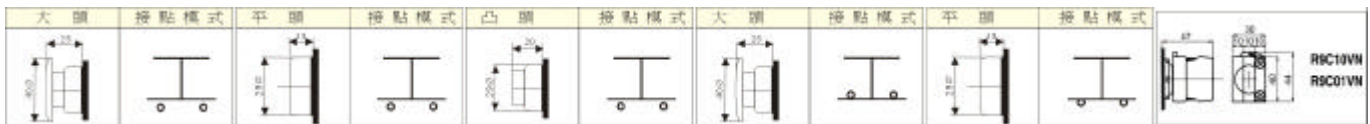

PartNo.	ProductNo.	Manuf.	Description	Pins/TerminalType	Color	Contact Function	ContactRating
12882	6501A-Y		旋入面板式鍵開關-黃色	2	黃色	A接點 OFF-(ON)	1 A 125 VAC
14453	91-CFM65+B+T2A	META	22m/m平頭按鈕開關	22mm	黑色	總歸+A接 點(2個) 2NO	
14454	91-CFM65+BU+T2A	META	22m/m平頭按鈕開關	22mm	藍色	總歸+A接 點(2個) 2NO	
14455	91-CFM65+G+T2A	META	22m/m平頭按鈕開關	22mm	綠色	總歸+A接 點(2個) 2NO	
14390	91-CFM65+Y+T2A	META	22m/m平頭按鈕開關	22mm	黃色	總歸+A接 點(2個) 2NO	
12862	91A-CFM65+G+T1A		22m/m平頭按鈕開關	22mm	綠色	總歸+A接 點1NO	
12863	91A-CFM65+R+T1A		22m/m平頭按鈕開關	22mm	紅色	總歸+A接 點1NO	
12861	91A-EM65+G+T1A		22m/m大頭按鈕開關	22mm	綠色	總歸+A接 點1NO	
12865	91A-GM65+Y+T1A		22m/m凸頭按鈕開關	22mm	黃色	總歸+A接 點1NO	
12866	91A-RA65+R+T1B		22m/m大頭緊急連鎖開關交替式	22mm	紅色	連鎖開關+B接點 1NC	



SWITCHES & CONTROL GEAR



PartNo.	ProductNo.	Manuf.	Description	Pins/TerminalType	Color	ContactFunction	ContactRating
12870	91A-T1B		22mm/m 開關接點1NC		91A系列開關	B接點 1NC	
14050	P9B01VN	GE	大型旋入面板式按鍵開關			b接點	10A AC15V-13DCV
14049	P9MEM4RN	GE	PE非照光大頭自動復歸式		紅色	B接點ON-(OFF)	10A AC15V-13DCV
12869	R9-C10		大型旋入面板式按鍵開關		91A系列開關	A接點 1NO	
17597	T2BARR-2A	TEND	25凸頭圓型開關	4P	紅色	2a	10A/125VAC
6030	T2BFRB-1A		25平頭圓型黑開關1a	2P	黑色	1a	
3704	T2BFRB-2A		25平頭圓型黑開關2a	4P	黑色	2a接點	10A 250VAC
12392	T2BFRBL-2A		25平頭圓型藍開關 2a	4P	藍色	2a	10A/125VAC
3703	T2BFRG-1A		25平頭圓型綠開關 1a	2P	綠色	1a接點	10A 250VAC
5433	T2BFRR-1A		25平頭圓型紅開關	2P	紅色	1a	10A/125VAC
5434	T2BFRR-2A		25平頭圓型紅開關 2a	4P	紅色	2a	10A/125VAC
12391	T2BFRY-2A		25平頭圓型黃開關 2a	4P	黃色	2a	10A/125VAC
11921	T2BKRR-2C		T2連鎖式圓形紅-2A2B (22mm)	8P	紅色	2A2B	10A/125VAC
3702	T2BMRR-2B		25大頭圓形紅開關	4P	紅色	2組1b	10A/125VAC
12428	TBF-251-G	TEND	綠平頭 25mm	4P	綠色	1a1b(NO-NC)	6 A 250V AC
12427	TBF-251-R	TEND	紅平頭 25mm	4P	紅色	1a1b(NO-NC)	6 A 250V AC
12429	TBF-251-Y	TEND	黃平頭 25mm	4P	黃色	1a1b(NO-NC)	6 A 250V AC
12380	TBF-251A-G	TEND	綠平頭 25mm	2P	綠色	1a(NO)	6 A 250V AC
3883	TBF-251A-R	TEND	紅平頭 25mm	2P	紅色	1a(NO)	6 A 250V AC
12381	TBF-251A-Y	TEND	黃平頭 25mm	2P	黃色	1a(NO)	6 A 250V AC
27181	TBK-252-R	TEND	紅連鎖式緊急開關	4P	紅色	2A3B(2NO-NC)	10A/125VAC
11922	TBK-252A	TEND	紅連鎖式緊急開關	4P	紅色	2A(2NO)	10A/125VAC
11923	TBKL-251A-R		大圓頭緊急開關NO	2P	紅色	1a(NO)	10A/125VAC
12382	TBL-251A-R		紅凸頭按鈕開關 1a(NO)	2P	紅色	1a(NO)	6 A 250V AC
12383	TBL-251A-Y		黃凸頭按鈕開關 1a(NO)	2P	黃色	1a(NO)	6 A 250V AC
3701	TBL-251AG		綠凸頭按鈕開關 1a(NO)	2P	綠色	1a(NO)	6 A 250V AC
14222	TN16-BKR4R1		連鎖圓型 IP40	4P	紅色	1A1B	250VAC/5A
23759	TN16-C		TN16接點座	4P	白/黑		
23812	TN16-SSS4B11		16/選擇方型果樹A1B	4P		1A1B	
20212	XB5-AA31	Schneider	Pushbuttonspring return		綠色/黑色	N/O	Flush
23309	XB5-AD53	Schneider	Pushbuttons,springreturn		黑色/黑色	N/O	
21350	ZB2-BE101		開關接點		綠色/黑色	NO	
13002	ZB2-BE701		大型旋入面板式按鍵開關			b接點	
13001	ZB2-BE702		大型旋入面板式按鍵開關			b接點	
23312	ZB5-AD5	Schneider	三段復歸選擇				
18011	ZB5-AS844	Schneider	22大頭急停按鈕		紅/黑	N/C	
23311	ZB5-AZ103	Schneider	接點組2a				
18012	ZB5-AZ104	Schneider	接點組			N/C+N/C	240V/3A

插入面板式按鍵開關 Panel Mounting

詳細產品規格--請點擊www.100y.com.tw



PartNo.	ProductNo.	Description	Pins/TerminalType	Color	ContactFunction	ContactRating
3464	6501A	旋入面板式鍵開關紅色	2	紅色	A接點 OFF-(ON)	1A 125V AC
10653	6513	白色復歸式開關	2	White	A復歸OFF-(ON)	
6721	6516	紅色按鍵開關	2P/焊線式	RED	B接點. OFF-(ON)	3A/125VAC
12055	6517	白色復歸式開關	2	白色	A接點 OFF-(ON)	



SWITCHES & CONTROL GEAR

小型旋入面板式按鍵開關
Miniature, Sub-Miniature Panel Mounting

詳細產品規格--請點擊www.100y.com.tw



PartNo.	ProductNo.	Description	Pins/Terminal Type	Color	Contact Function	Contact Rating
11989	6506A	紅色按鍵開關復歸式	2P	紅	A接點OFF-(ON)	3A/250Vac
8555	6506B	紅色有段開關交替式	2P	紅色	有段 ON-OFF	3A/250Vac
4287	6520C	有段ON-ON開關焊線式	6P		有段ON-ON	AC125V/3A
11651	7ND7P1B1M1QE	按鍵開關	6P	Red	1-3,4-6ON,1-2,4-5 MOM	1A 120VAC Or 38VDC
3449	7NS7P1B1M1QE	Red按鍵開關	3Pin	Red	1-3ON,1-2MOM	1A120VAC Or 38VDC
4533	8MS9B500M1QE	按鍵開關復歸式(附帽蓋)	2P	Red	OFF-(ON)	1A/125Vac
14146	R13-502A-05	紅色按鍵開關(復歸式)	2Pin/Solder	Red/Blak	A接點OFF-(ON)	3A125VAC/1.5A250VAC
14281	R13-502MC-05	紅按鈕金屬底	3P/SO Solder	紅色	ON-(ON)SPDT	3A/125V 5A/250V
14132	R13-508BL-05	有段接點 w/3VdcLED	4P/SO Solder	紅色	A接點OFF-ON SPST	3A125VAC/1.5A250VAC
3382	YR18-21A-3	紅色按鈕開關交替式 12	2Pin	Red	OFF-ON(A接點)	3A/250Vac
7905	YR18-21A-5	黃色按鈕開關交替式	2P	黃色	OFF-ON(A接點)	3A/250Vac
3395	YR18-21B-3	紅色按鍵開關復歸式	2P	紅色	OFF-ON(A接點)	3A/250Vac
7900	YR18-21B-5	黃色按鍵開關復歸式	2P	黃色	OFF-ON(A接點)	3A/250Vac
5681	YR18-23A-3	紅色按鈕開關交替式	2P	紅色	OFF-ON(A接點)	3A/250Vac
7903	YR18-23A-5	黃色按鈕開關交替式	2P	黃色	OFF-ON(A接點)	3A/250Vac
2208	YR18-23B-3	紅色按鍵開關(復歸式)	2Pin	Red	OFF-ON(A接點)	3A/250Vac
7904	YR18-23B-5	黃色按鍵開關(復歸式)	2P	黃色	OFF-ON(A接點)	3A/250Vac
3411	YR18-24A-3	紅色按鈕開關交替式 12	2P	紅色	OFF-ON(A接點)	3A/125Vac
2210	YR18-24B-3	紅色按鈕開關復歸式 1	2Pin	Red	OFF-ON(A接點)	3A/250Vac
5680	YR18-25A-3	紅色按鈕開關交替式	2P	紅色	OFF-ON(A接點)	3A/250Vac
7902	YR18-25A-5	黃色按鈕開關交替式	2P	黃色	OFF-ON(A接點)	3A/250Vac
7899	YR18-25B-3	紅色按鈕開關(復歸式)	2P	紅色	OFF-ON(A接點)	3A/250Vac
7901	YR18-25B-5	黃色按鈕開關(復歸式)	2P	黃色	OFF-ON(A接點)	3A/250Vac
3394	YR18-26A-3	紅色按鈕開關交替式	2P	紅色	OFF-ON(A接點)	3A/250Vac
3393	YR18-26B-3	紅色按鈕開關復歸式 12	2P	紅色	OFF-ON(A接點)	3A/250Vac
2209	YR18-29A-3	紅色按鈕開關(復歸式)	2Pin	Red	OFF-ON(A接點)	1A 250Vac
7906	YR18-29A-5	黃色按鈕開關(復歸式)	2P	黃色	OFF-ON(A接點)	1A/250Vac
3383	YR18-30B-3	紅色按鈕開關(復歸式)	2Pin	Red	ON-OFF(B接點)	1A 250Vac

(照光) 大型旋入面板式按鈕開關
Standard Illuminated With Snap-action
Switch Element

詳細產品規格--請點擊www.100y.com.tw



PartNo.	ProductNo.	Manuf	Description	安裝孔徑	Lamp(V)	Color	Contact Function	Contact Rating
19810	01-121.025	EAO	Indicator, Lighted Pushbuttons with Snap Acting Switch Element	18*24		白色 黑色	1Pole	250VAC/5A
19811	01-122.025	EAO	Indicator, Lighted Pushbutton with Snap Acting Switch Element	18*24		白色 黑色	2Pole	250VAC/5A
14086	01-264.0252		指示燈照光(焊接式)按鈕開關	16mm		綠色	1A1B	5A/250VAC
4363	01P-CA40.S1P		圓形帶燈交替式按鈕開關	16mm			1A1B	5A/250VAC
15474	01P-CA65.S1P+R+L06		圓形帶燈交替式防水按鈕開關	16mm	6Vdc	紅色	1A1B	5A/250VAC
14692	01P-CA65.S1P+V+L12		圓形帶燈交替式防水按鈕開關	16mm	12Vdc	深綠色	1A1B	5A 250V
12471	01P-C140.Q	META	圓形指示燈	16mm				



SWITCHES & CONTROL GEAR

PartNo.	ProductNo.	Manuf	Description	安裝孔徑	Lamp(V)	Color	ContactFunction	ContactRating
21629	01P-CI40.S	META	圓形指示燈16mm	16mm				
17494	01P-CM40.Q1P		圓形帶燈復歸式按鈕開關	16mm			1A1B	5A/250VAC
4362	01P-CM40.S1P		圓形帶燈復歸式按鈕開關	16mm			1A1B	5A/250VAC
18014	01P-RA40.Q1P	META	長方形交替式按鈕開關	16mm			1A1B	250VAC/5A
12925	01P-RA40.Q1P+O+D24		圓形帶燈交替式按鈕開關	16mm	28Vdc	紅色	1A1B	250Vac/5A
3212	01P-RA40.S1P		長方形帶燈交替式按鈕開關	16mm			1A1B	5A 250V
7873	01P-RA40.S2P		長方形帶燈交替式按鈕開關	16mm			2A2B	5A/ 250VAC
28500	01P-RI40.Q		長方形指示燈標準型)	16m/m				5A/250VAC
16910	01P-RI40.S		長方形指示燈標準型)	16m/m				5A/250VAC
18013	01P-RM40.Q1P		長方形復歸式按鈕開關	16mm			1A1B	250VAC/5A
12762	01P-RM40.Q1P+B+D12		長方形帶燈復歸式按鈕開關防水按鈕開關	16mm	14Vdc	藍色	1A1B	5A/250V
3213	01P-RM40.S1P		長方形帶燈復歸式按鈕開關	16mm			1A1B	5A/250V
2567	01P-SA40.S1P		正方形帶燈交替式按鈕開關	16mm			1A1B	250VAC/5A
21770	01P-SA65.S1P+R+D12	META	正方形交替式按鈕開關	16mm	D14V	紅/黑		250VAC/5A
21771	01P-SA65.S1P+Y+D12	META	正方形交替式按鈕開關	16mm	D14V	黃/黑		250VAC/5A
2573	01P-SM40.S1P		正方形帶燈復歸式按鈕開關	16mm			1A1B	250VAC/5A
28303	30-530.02	EAO	二連動開關	24*35mm			2A2B	250Vac/5A
28307	30-530.4	EAO	四連動開關	24*72mm			2A2B	250Vac/5A
3220	31-121.0252	EAO	指示燈照光焊接式按鈕開關	16mm			1A1B	5A/ 250VAC
27746	31-122.0252+2		瞬間焊接式按鈕開關	16mm			1A1B	5A/ 250VAC
4848	31-261.0252		指示燈照光交替式按鈕開關	16mm			1A1B	5A/250V
28305	31-263.0252		指示燈照光焊接式按鈕開關	16mm			3A3B	5A/ 250VAC
28306	31-264.0252	EAO	指示燈照光焊接式按鈕開關	16mm			4A4B	5A/ 250VAC
19826	31-421.036	EAO	LOW-LEVEL SWITCHES, DPST, MOMENTARY	18*24mm		白色黑色	DPST (2 N.O.)	48V/1.2W
19812	41-121.015	EAO	Indicator,LightedPushbuttonswith SnapActing SwitchElement	24*18		白色黑色	2Pole	250VAV/5A
19825	41-261.025	EAO	Indicator,LightedPushbuttonswith SnapActing SwitchElement	24*18		白色黑色	1Pole	250VAV/5A
12864	91A-CFM65+R+T1A+A22		22m/m平頭帶燈按鈕開關復歸式1P65,紅1NO	22mm	220V燈	紅	復歸+A接點1NO	
28363	T2IFR7G-1C		T2直照平圓鎢絲24V綠1C	22/25mm	24V		1A1B	平頭圓形綠
28350	T2TFR1G-1C		T2照光平圓110/6V綠1C	22/25mm	6.3V	平頭圓形綠	1A1B	110/5 VAC
28229	T2TFR2G-2C		T2照光平圓220/6V綠2C	22/25mm	6.3V	平頭圓形綠	1A1B	220/5 VAC

按鈕色蓋 (長方型正方形圓型) 工具 Accessories for Standard Illuminated

詳細產品規格--請點擊www.100y.com.tw

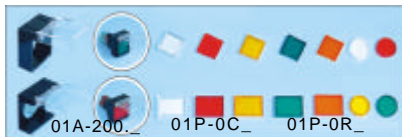

PartNo.	ProductNo.	Description	Type	Color	適用開關	尺寸(mm)
14088	01-982.5	長方形色蓋	長方	綠	eao 01系列	12.8*18.8
23225	01-982.7	長方形色蓋	長方	白色	eao 01系列	12.8*18.8
3214	01A-200.R	長方保護蓋	長方	透明	長方形帶燈按鈕開關	
2157	01A-200.S	正方形保護蓋	正方	透明	正方形帶燈按鈕開關	
4775	01P-0C0	圓形色蓋		白色	For 01P-xx40.xxx	15.8mmdia.
4773	01P-0C1	圓形按鈕色蓋		紅色	For 01P-xx40.xxx	15.8mmdia.
4774	01P-0C2	圓形按鈕色蓋		黃色	For 01P-xx40.xxx	15.8mmdia.
4776	01P-0C6	圓形按鈕色蓋		深綠色	For 01P-xx40.xxx	15.8mm dia.
2574	01P-0R0	長方形白色按鈕色蓋		WHITE	For 01P-xx40.xxx	21.01*15.19mm
2575	01P-0R1	長方形按鈕色蓋		紅色	For 01P-xx40.xxx	21.01*15.19mm
6342	01P-0R2	長方形按鈕色蓋		黃色	For 01P-xx40.xxx	21.01*15.19mm
6344	01P-0R5	長方形按鈕色蓋		橙色	For 01P-xx40.xxx	21.01*15.19mm
6343	01P-0R6	長方形按鈕色蓋	長方形	綠色	For 01P-xx40.xxx	21.01*15.19mm
2568	01P-0S0	正方形按鈕色蓋		WHITE	For 01P-xx40.xxx	15.36*15.36mm
2569	01P-0S1	正方形按鈕色蓋		RED	For 01P-xx40.xxx	15.36*15.36mm
2570	01P-0S2	正方形按鈕色蓋		YELLOW	For 01P-xx40.xxx	15.36*15.36mm
2571	01P-0S3	正方形按鈕色蓋		GREEN	For 01P-xx40.xxx	15.36*15.36mm
2572	01P-0S5	正方形按鈕色蓋		ORANGE	For 01P-xx40.xxx	21.01*15.19mm
10632	01P-T02+01P-T03	色蓋拔取夾燈泡取置器				
3215	31-904.2A	長方按鈕色蓋		紅色	For 31-121.&32-261.	15.2*21.2
3216	31-904.3A	長方按鈕色蓋		橙色	For 31-121.&32-261.	15.2*21.2
3253	31-904.4A	長方按鈕色蓋		黃色	For 31-121.&32-261.	15.2*21.2
3217	31-904.5A	長方按鈕色蓋		綠色	For 31-121.&32-261.	15.2*21.2
3218	31-904.6A	長方按鈕色蓋		藍色	For 31-121.&32-261.	15.2*21.2
3254	31-904.7A	長方按鈕色蓋	長方	白色	For 31-121.&32-261.	15.2*21.2



SWITCHES & CONTROL GEAR

動力盒式押扣開關 Pushbutton Stations

詳細產品規格--請點擊www.100y.com.tw



TBSN-315



TBSN-315C



TBSY-315
TBSY-330



TPB-2



TPB-3

PartNo.	ProductNo.	Manuf.	Description	ContactFunction
9835	TBSN-315	TEND	動力押扣開關	3P-15A/2.2KW
9834	TBSN-315C	TEND	動力押扣開關	3P/15A/2.2KW
9837	TBSY-315	TEND	動力押扣開關	3P/15A/2.2KW
9836	TBSY-330	TEND	動力押扣開關	3P/30A/3.7KW
9833	TPB-2		工業按鈕開關	
5436	TPB-3		工業按鈕開關	3A/250V

連動按鍵開關+帽蓋 可用於PC電源的連動按鍵開關 PC PushButton Switch

詳細產品規格--請點擊www.100y.com.tw



6509A-2P

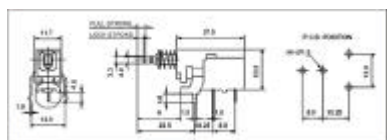

6509B-4P

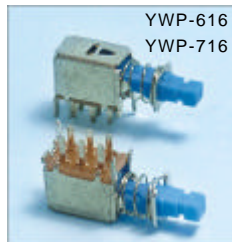
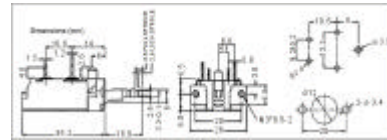

YWP-616
YWP-716

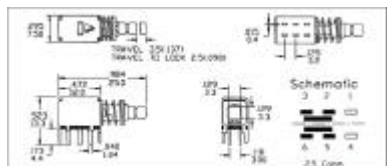

Part No.	ProductNo.	Description	Type	Pins	耐壓耐電流值
4237	6509A-2P	按鍵開關	ON-OFF	2 P	250V/10A
10018	6509B-4P	按鍵開關	ON-OFF	4 P	250V/10A
14570	Y WP-616	按鍵開關(復歸式)		6 P	200mA/30V
14571	Y WP-716	按鍵開關(交替式)		6 P	200mA/30V

可插板式連動按鍵開關 Sub-Miniature for PCB

詳細產品規格--請點擊www.100y.com.tw

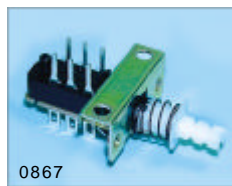

0867

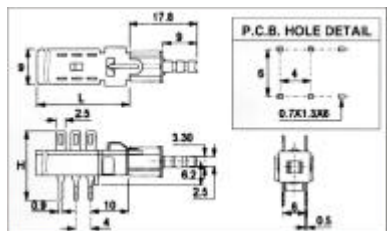

0868

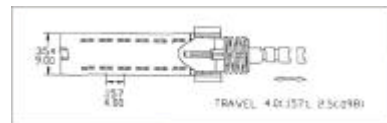

PS-22F78

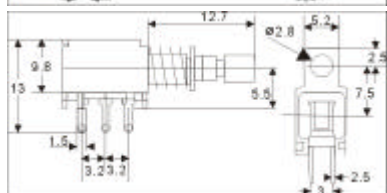

5044

PartNo.	ProductNo.	Description	Type	Pins	耐壓耐電流值
6519	0867	連動按鍵開關	ON-ON	6 P	250VAC/0.5A
7091	0868	連動按鍵開關		12P	AC100V/0.5A, AC250V/0.2A, DC25V/1A
18186	5044	連動按鍵開關		12P	
16458	PS-22F78	連動按鍵無段開關	ON-(OFF)	6 P	30VDC/0.3A



SWITCHES & CONTROL GEAR

按鍵蓋帽 Buttons

詳細產品規格--請點擊www.100y.com.tw

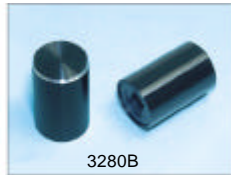
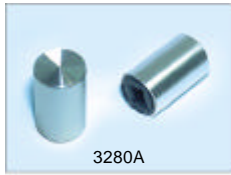

PartNo.	ProductNo.	Description	規格
7693	3280A	銀色鋁按鍵帽蓋	10*16mm
8364	3280B	黑色鋁帽蓋	10*16mm

切換開關 附燈電源切換開關 Illuminated Power Rocker Switch

詳細產品規格--請點擊www.100y.com.tw

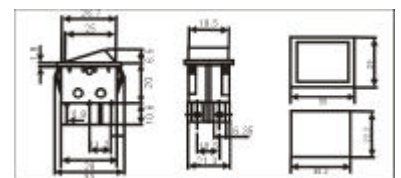
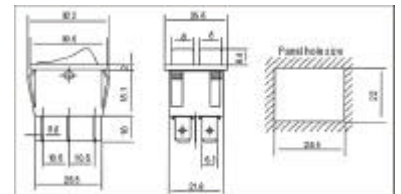
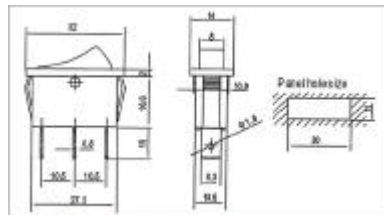
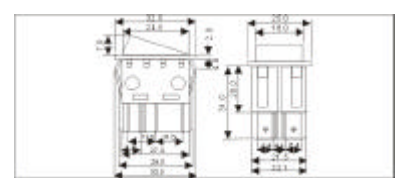
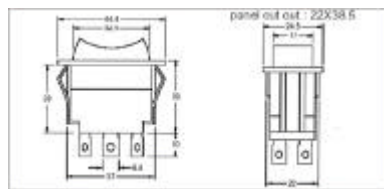
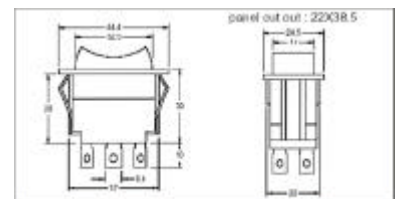
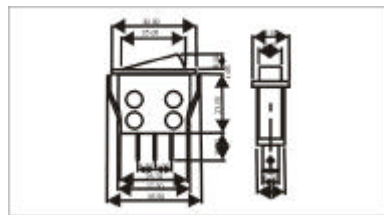

PartNo.	ProductNo.	Description	Pins/Terminal Type	Contact Type	耐電流電壓值	Button/Body Color
7472	34217-091-62	跳板開關	3P	ON-OFF	15A/250Vac	紅按鈕黑底
7479	34217-091-63	跳板開關	3P	ON-OFF	15A/250Vac	黃按鈕黑底
4354	34217-191-65	跳板開關	3P	ON-OFF	15A/250Vac	綠按鈕黑底
4847	34217-199-65	跳板開關	3P	ON-OFF	15A/250Vac	綠按鈕白底
4846	34231-099-62	跳板開關	3P	ON-OFF	15A/250Vac	紅按鈕白底
12056	34231-099-63	跳板開關	3P	ON-OFF	15A/250Vac	黃按鈕白底
4849	37917-021-1302	跳板開關	4P	ON/OFF	15A/250Vac	紅按鈕黑底
5080	37917-029-1102	跳板開關	4P	ON/OFF	15A/250Vac	紅按鈕白底
4355	37917-029-1104	跳板開關	4P	ON-OFF	15A/250Vac	綠按鈕白底
13736	5199	車用帶燈開關	4P	ON-OFF	24V/15A	
13737	5200	車用帶燈開關	4P	ON-OFF	10A/24VDC	
8394	6070P-B	附燈電源切換開關	6P	6P-2	10A/250Vac	雙紅按鈕黑底
8393	6073B-B/RUL	附燈電源切換開關	3P	ON-OFF	10A/250Vac	紅按鈕黑底
11637	6092F-6P	附燈切換開關	6P	ON-ON	15A/250Vac	紅按鈕黑底
11085	6093E	附燈電源開關切換開關	4P	ON-OFF	15A/250Vac	ILLUMINATED
4235	6100B-3P	附燈電源切換開關	3P	ON-OFF	10A/250Vac	附燈紅按鈕黑底13.5*28
3463	6110B	發光切換開關	3P	SPST	5A/250Vac	紅按鈕黑底
11636	6110C-4P	附燈電源切換開關附燈電源切換開關	4P	ON-OFF	5A/250Vac	附燈紅按鈕黑底



SWITCHES & CONTROL GEAR



6093E

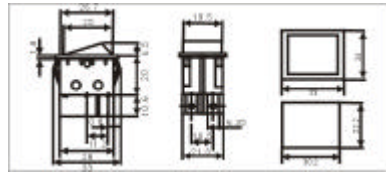

R13-104B-B/R

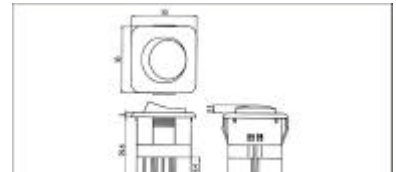

6100B-3P

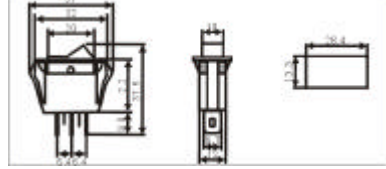

R13-135B2-02



6100B

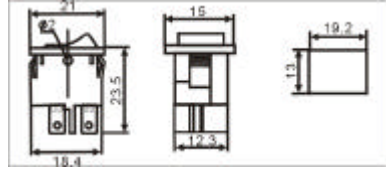

R13-1128BP-02

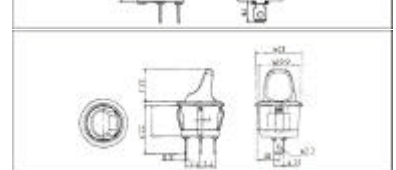

R13-205L-B/R

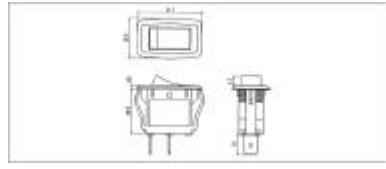

R13-244B-B/_

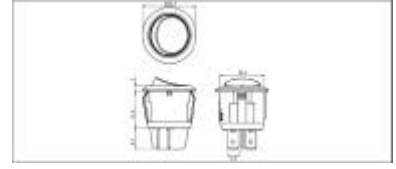

PartNo.	ProductNo.	Manuf.	Description	Pins/TerminalType	ContactType	耐電流電壓值	Button/BodyColor
15086	R13-104B-B/R	SCI	搖頭開關	4P/DPST	ON/OFF	16A 125VAC/10A250VAC	紅色黑色
14133	R13-112BP-02	SCI	搖頭開關	3P	ON-OFF	10A125VAC/6A250VAC	附燈紅鈕黑底
14280	R13-135B2-02	SCI	搖頭開關	3P/.187"SQ Quick connect	SPSTON-OFF	10A/125VAC 6A/250VAC	黑按鈕黑底紅指示燈
14410	R13-205L-B/R	SCI	搖頭開關	4P/SO Solder	SPSTON-OFF	16A 125V/10A 250V	黑按鈕黑底/紅
14325	R13-244B-B/G	SCI	搖頭開關	4P/4.8*0.8t Quick connect	DPST ON-OFF	16A125V/10A250V	綠按鈕黑底
22070	R13-244B-B/R	SCI	搖頭開關	4P/4.8*0.8t Quick connect	DPST ON-OFF	16A125V/10A250V	紅按鈕黑底
14149	R13-66B-02	SCI	附燈電源切換開關	3P/QuickConnect	SPSTON-OFF	10A125VAC/6A250VAC	Red/Black
14283	R13-66L-05	SCI	搖頭開關	4P/SO Solder	SPSTON-OFF	10A/125V 6A/250V	黑按鈕黑底/LED燈
14409	R13-70B-B/R	SCI	搖頭開關	3P/6.3*0.8t Quick connect	SPSTON-OFF	16A125V/10A250VAC	紅按鈕黑底 附220V燈
14134	R13-72B-01	SCI	附燈電源切換開關	3P/6.3*0.8t Quick Connect	SPSTON-OFF	15150V/10A250V	綠按鈕黑底
14411	R13-72B-B/R	SCI	搖頭開關	3P/SO6.3/0.8t Quick connect	SPSTON-OFF	15A125V/10A250V	紅按鈕黑底
14156	R13-73B-02	SCI	搖頭開關	3P/4.8*0.8t Quick Connect)	SPSTON-OFF	10A150V/6A250V	紅按鈕黑底
18072	RL1-6073B-W/R	SCI	附燈電源切換開關	3P	ON-OFF	10A/250Vac	紅按鈕白底

無燈電源切換開關 PowerRockerSwitch

詳細產品規格--請點擊www.100y.com.tw



3MDIR103M1Q0

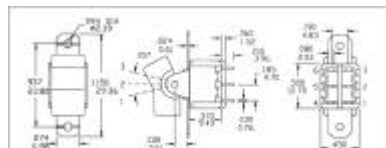

3MSIR103M1Q0

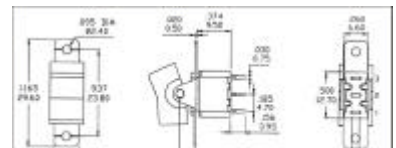

6062A-2P 5009A

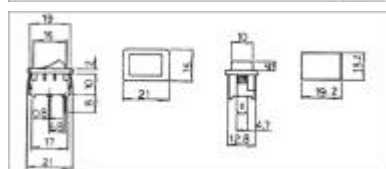

6020A-2P2

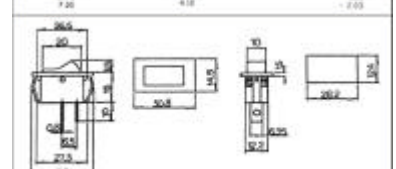

6010A-2P2

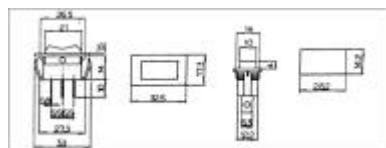

6018

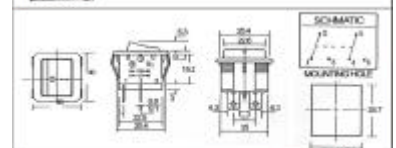

詳細產品規格--請點擊www.100y.com.tw



SWITCHES & CONTROL GEAR



6090C-6P3

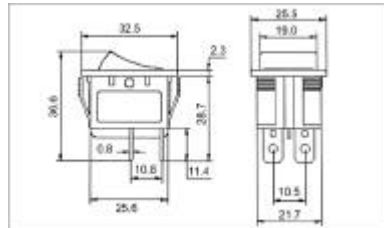

R13-136B-05

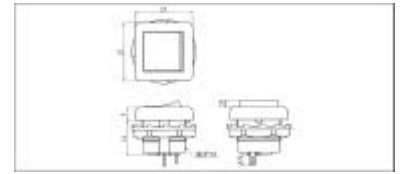

6110A

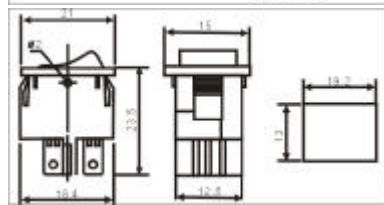

R6-BB-0-2P

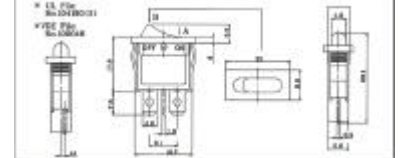

6062A-2P-黑/紅

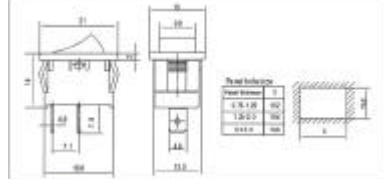

RL-3P3

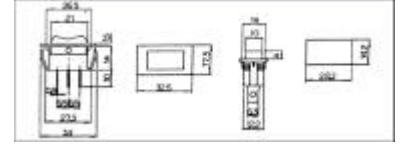

PartNo.	ProductNo.	Manuf.	Description	ContactType	Button/BodyColor	Pins/TerminalType	Size	耐電流電壓值
7907	3MD1R103M1Q0		紅色開關	ON-OFF		6P2		5A/125Vac
7908	3MS1R103M1Q0		紅色開關	ON-OFF		3P2		5A/125Vac
13335	5009A		電源切換開關			2 P		
12041	5054-B		線上開關	ON-OFF	2A(黑色)			
10654	6010A-2P2		電源切換開關	ON-OFF	紅按鈕黑底	2P2	14*28	10A 125 VAC
3467	6018		電腦切換開關	ON-OFF		4P2	25*25	10A 125/250V AC
10886	6020A-2P2		電源切換開關	ON-OFF	白按鈕黑底	2P2	12*28	
4234	6062A-2P		電源切換開關	ON-OFF		2P2	13*19	6A/125Vac
19582	6062A-2P-黑/紅		電源切換開關(黑紅)	ON-OFF		2P2	13*19	6A/125Vac
20391	6062B-3P2-黑黑		電源切換開關(黑黑)	ON-ON	黑/黑有白點	3P2	13*19	6A/125Vac
24663	6064A-B		切換開關	ON-OFF	黑/黑	2P2	13*19	5A/125Vac
11638	6090C-6P3		二段式電源切換開關	ON-OFF-ON		6P6	22*30	10A/250Vac
15433	6110A		電源切換開關	DPST	全黑	4 P	21*15*23.5	AC10A125V, 6A 250V
14279	R13-136B-05	SCI	切換開關	DPDTON-ON	紅按鈕黑底	6P/Solder	23L*23W*19D	10A125V/6A250V
14284	R13-243A-02	SCI	切換開關(交替式)	SPSTON-OFF	黑按鈕黑底白點	2P/.187"SQQuickconnect	L21*W9.5*D23.7	10A/125V 6A/250V
12148	R13-243F-02	SCI	切換開關(復歸式)	SPSTON-OFF	黑按鈕黑底/	2P/4.8*0.8t Quickconnect	L21*W9.5*D23.7	10A/125VAC 6A/250VAC
14285	R13-73A-10	SCI	無燈電源切換開關	DPSTON-OFF	黑按鈕黑底	4P/PCANGLE PCMounting	L21*W15*D24	10A/125V 6A/250V
10020	R6-BB-0-2P		切換開關	ON-OFF	黑按鈕黑底白點	2	6.8*19	10A/125Vac
8392	RL-3P3		電源切換開關	OF-OFF-ON	黑按鈕黑底/	3P3	13*19	10A/125VacUL

波段開關 一層波段開關 Rotary Switches

詳細產品規格--請點擊www.100y.com.tw



5060A
5060B
5060D

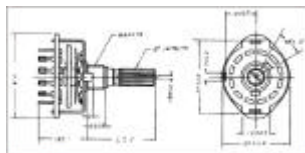

SRRN124
SRRN134
SRRN143
SRRN152
SRRN162
SRRN1C1S

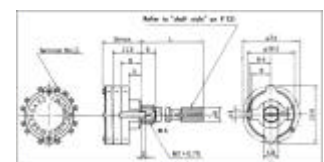

PartNo.	ProductNo.	Description	Num.ofSections(層)	Num.ofPosition(段)	Num.ofPoles(回路)
5961	5060A	一層段波段開關	1	3	
5962	5060B	一層段波段開關	1	4	
5963	5060D	一層段波段開關	1	6	
28114	SRRN124	一層段組波段開關	1	2	4組
6745	SRRN134	一層段組波段開關	1	3	4組
6746	SRRN143	一層段組波段開關	1	4	3組
8086	SRRN152	一層段組波段開關	1	5	2
8088	SRRN162	一層段組波段開關	1	6	2
8087	SRRN1C1S	一層1 2段組波段開關	1	12	1組



SWITCHES & CONTROL GEAR

二層波段開關 Rotary Switches

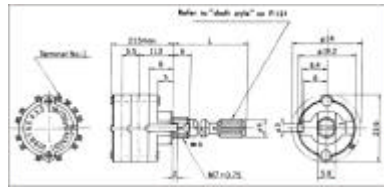

詳細產品規格--請點擊www.100y.com.tw

Features:

Hermetically sealed, compact rotary switch.
Excellent operational feeling and environmental characteristics.
Leadwiring type.

Applications:

all types of electronic equipments such as measuring instruments and control equipment.

PartNo.	ProductNo.	Description	Num.ofSections(層)	Num.ofPosition(段)	Num.ofPoles(回路)
28115	SRRN234	二層3段波段開關	3	2	4
7519	SRRN243	二層4段波後開關 A LPS	4	2	3
8089	SRRN252	二層5段2組 波段開關	5	2	2
28117	SRRN262	二層6段波段開關	6	2	2
28118	SRRN2C1	二層12段波段開關	12	2	1

工業--二位選擇開關 2Way Select Switch

詳細產品規格--請點擊www.100y.com.tw



PartNo.	ProductNo.	Description	Volt./Current	固定孔徑	Color	ContactType
19472	TBC-1					
8464	TSS-2512-B	選擇開關	10A/125VAC	25	黑色	1A1B
9842	TSS-2512-G	選擇開關	10A/125VAC	25	綠色	1A1B
9843	TSS-2512-R	選擇開關	10A/125VAC	25	紅色	1A1B
9831	TSS-3012-B	選擇開關	10A/125VAC	30	黑色	1A1B
9832	TSS-3012-G	選擇開關	10A/125VAC	30	綠色	1A1B
8465	TSS-3012-R	選擇開關	10A/125VAC	30	紅色	1A1B

工業--三位選擇開關 3Way Select Switch

詳細產品規格--請點擊www.100y.com.tw



PartNo.	ProductNo.	Manuf.	Description	Lamp(V)	固定孔徑	Color	ContactType
12867	91A-CSB65+K+T1A	META	22m/m 選擇短柄3交替1P65, 黑 1NO		22m/m	黑	短柄3交替 A接點 1NO
12868	91A-CSB65+R+T1A+A22	META	22m/m 帶燈選擇短柄3位交替1P65紅 1NO	220VAC	22mm	紅	短柄位交替 1NO

滑動 (撥動) 開關 滑動開關 Slide Switch

詳細產品規格--請點擊www.100y.com.tw

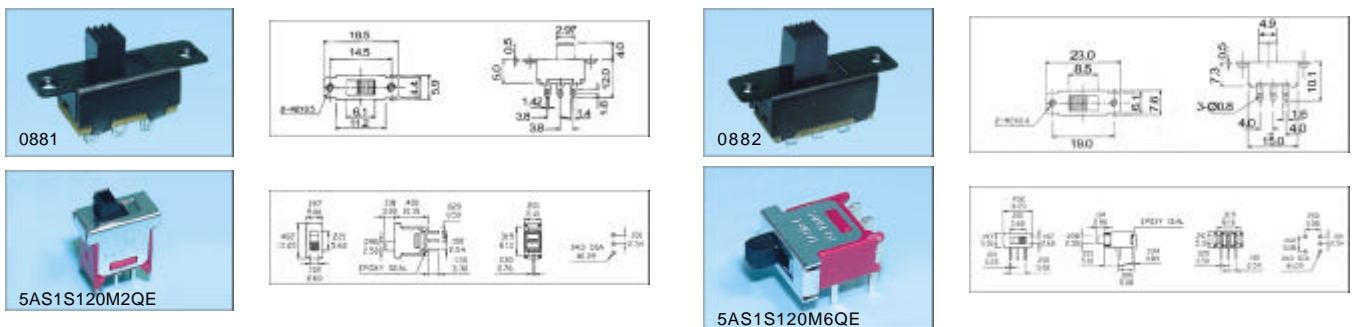

SWITCHES & CONTROL GEAR

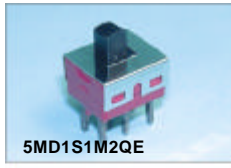

5MD1S1M2QE

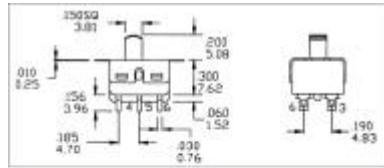

5MS1S120M6QE

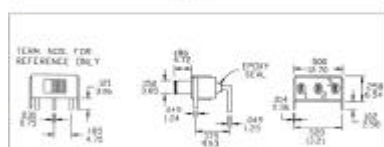

SK12E12G7

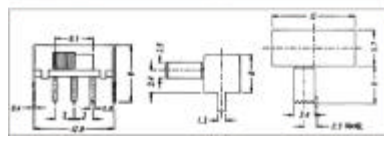

5MD1S120M6QE

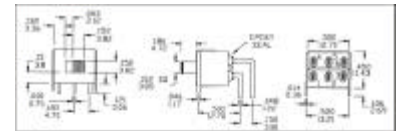

SK-12D02

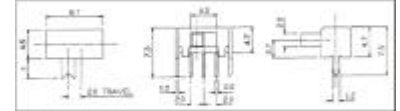

SS-22H06-V4

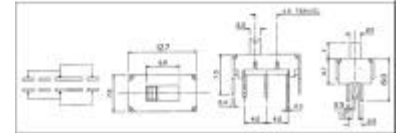

PartNo.	ProductNo.	Description	Type	耐電流電壓值	Pins/TerminalType	規格
7840	0881	小3 P滑動開關2段	ON-OFF	1.5A/250Vac	3P	8.7*4.5*7.5mm
7841	0882	小6 P滑動開關2段	ON-OFF		6P3	
4305	5AS1S120M2QE	滑動開關	ON-OFF			
7910	5AS1S120M6QE	90 滑動開關	ON-OFF	1.5A/250Vac		
11506	5MDIS120M6QE	90 滑動開關	ON-OFF	5A/125Vac	6P2	
11507	5MDIS120M2QE	180 °滑動開關	ON-OFF	5A/125Vac	6P3	
10745	5MS1S120M6QE	90 滑動開關	ON-OFF	5A/125Vac		
11334	SK-12D02	90 滑動開關			3P2	
12696	SK12E12G7	滑動開關				
12971	SS-22H06-V4	滑動開關			6P	

搖臂開關 搖臂開關 Toggle Switch

詳細產品規格--請點擊www.100y.com.tw



6318-4P2

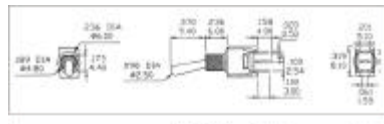

6323N-2P2

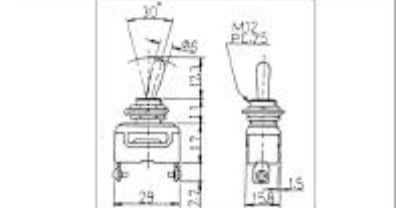
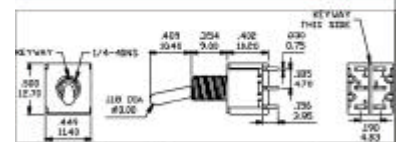
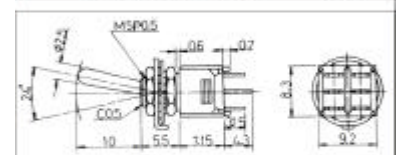
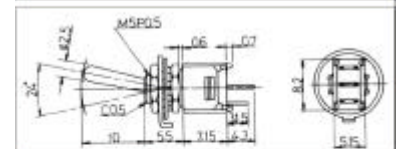
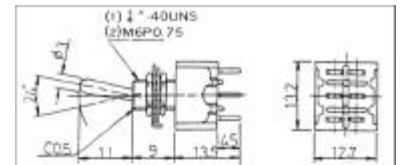
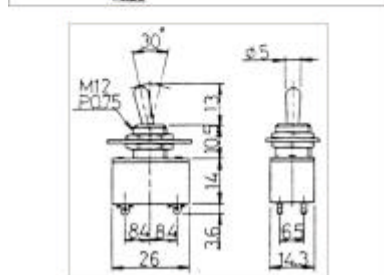
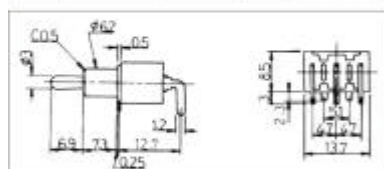
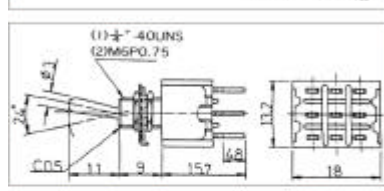
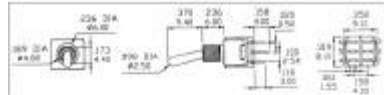

SWITCHES & CONTROL GEAR

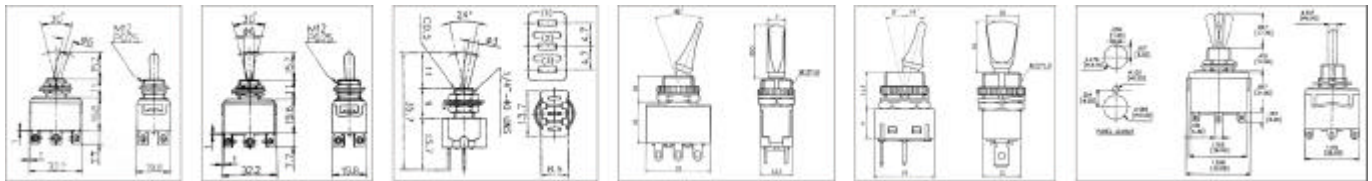
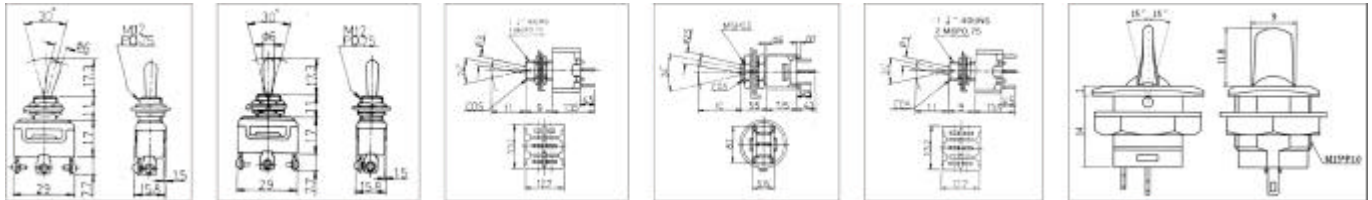
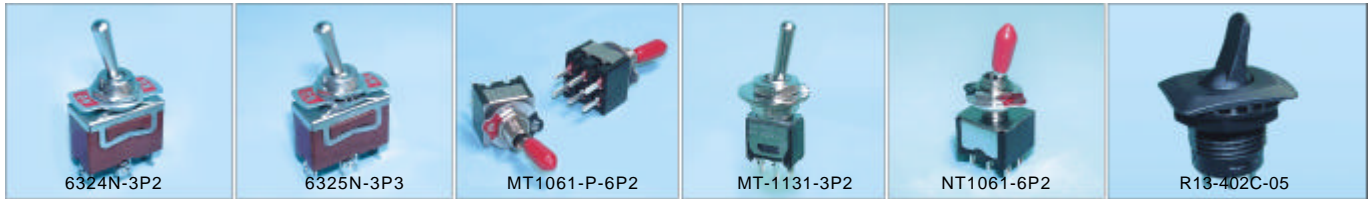

PartNo.	ProductNo.	Manuf.	Description	No.ofPos.	耐壓電流值	顏色	Type
21816	2AD1T1B4M2GE	TAIWAY	防水防靜電手套把搖臂開關	DPDT	1.5A/250VAC	銀柄紅底	200A
21817	2AD4T1B4M2GE	TAIWAY	防水防靜電手套把搖臂開關	DPDT	1.5A/250VAC	銀柄紅底	200A
21813	2AS1T1B4M2GE	TAIWAY	防水防靜電手套把搖臂開關	SPDT	1.5A/250VAC	銀柄紅底	200A
21815	2AS4T1B4M2GE	TAIWAY	防水防靜電手套把搖臂開關	SPDT	1.5A/250VAC	銀柄紅底	200A
21809	2BS1P1B4M6RE	TAIWAY	SMD防水防靜電手把搖臂開關	SPDT	0.4VA	黑柄白底	200B
21811	2BS3P1B4M6RE	TAIWAY	SMD防水防靜電手把搖臂開關	SPDT	0.4VA	黑柄白底	200B
21812	2BS4P1B4M6RE	TAIWAY	SMD防水防靜電手把搖臂開關	SPDT	0.4VA	黑柄白底	200B
7909	2MD1T1B1M1QE		搖臂開關	6P2	250VAC/1.5A		ON-ON
17834	2MD1T1B1M2QE		搖臂開關	6P2	250VAC/1.5A		ON-ON
11658	2MS4T1B3M1QO		搖臂開關(復歸式)	3P3	250VAC/1.5A		(ON)-OFF-(ON)
4230	6303CNR-6P3		搖臂開關	6P3	6A/125Vac		ON-OFF-ON
13317	6304AN-9P2		搖臂開關	9P2	6A/125V		ON-ON
13318	6304BN-9P3		搖臂開關	9P3	6A/125V		ON-OFF-ON
5676	6306A		90 搖臂開關	3P2	6A/125Vac		ON-ON
11131	6314-2P2		搖臂開關	2P2	3A/125Vac		ON-OFF
5675	6316		搖臂開關	6P2	3A/125Vac		ON-ON
12079	6318-4P2		搖臂開關	4P2	2A-250V 4A-125V		ON-OFF
8399	6323N-2P2		搖臂開關	2P2	15A/125Vac		ON-OFF
7741	6324N-3P2		搖臂開關	3P2	10A/250Vac		ON-ON
8398	6325N-3P3		搖臂開關	3P3	15A/125V		ON-OFF-ON
7745	6327N-6P2		搖臂開關	6P2	10A/250Vac		ON-ON
11140	6328-6P3		搖臂開關	6P3	15A/125Vac		ON-OFF-ON
4231	MT-1021		搖臂開關	2P2	6A/125VacUL		ON-OFF
7739	MT-1031-3P2		搖臂開關	3P2	6A/125Vac		ON-ON
4232	MT-1032-3P3NR		搖臂開關	3P3	6A/125Vac		ON-OFF-ON
4233	MT-1131-3P2		搖臂開關	3P2	3A/125Vac		ON-ON
28301	MT-1131P-3P2		搖臂開關	3P2	1.5A/250Vac	紅	ON-ON
16641	MT1061-P-6P2		搖臂開關(插板式)	6P2	125Vac/6A		ON-OFF
7738	NT1061-6P2		搖頭開關	6P2	125Vac/6A		ON-OFF
14138	R13-402C-05	SCI	搖臂開關	3 PSPDT	6A125VAC/3A250VAC	黑柄黑底	SPDT ON-ON
14282	R13-406F2-05	SCI	搖臂開關	4P/SOSolder	6A/125V 3A/250V	金屬柄黑底	DPST ON-OFF
14407	R13-412A1-HWR	SCI	搖臂開關	2 FSPDT	10A125VAC/6A250VAC	黑柄黑底	SPST ON-OFF
5650	Y7033-K1C3T1		搖臂開關	9P3	10A/250Vac		ON-OFF-ON



SWITCHES & CONTROL GEAR

微動開關 大微動開關 Micro Switch

詳細產品規格--請點擊www.100y.com.tw



5101

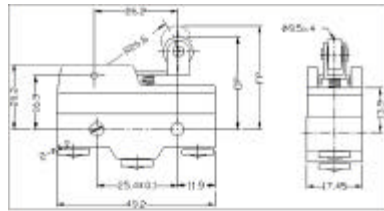

5102

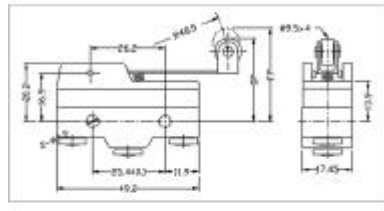

5104

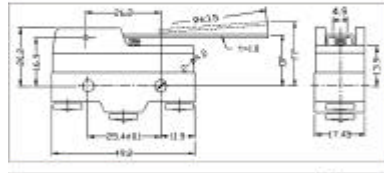

5105

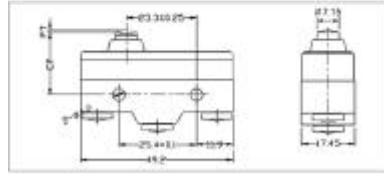

5106

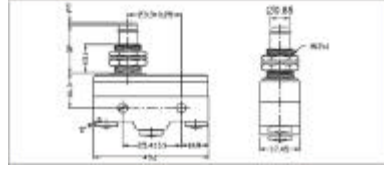

Z-15HW78-B

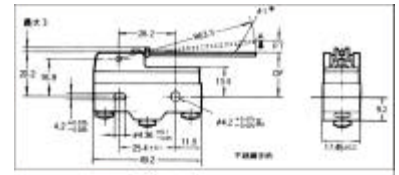

TM-1308A

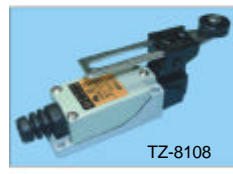
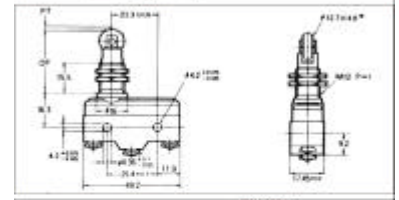

TZ-8108

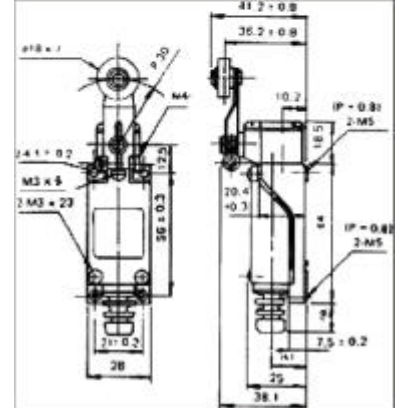

TZ-8104

Part No.	ProductNo.	Manuf.	Description	耐壓電流值
11188	5101		短輪大微動開關	15A/125/250Vac
3587	5102		長輪微動開關	15A/125/250Vac
8368	5104		直片微動開關	15A/125/250Vac
3552	5105		短押扣微動開關	15A/125/250Vac
7703	5106		長押扣微動開關	15A/125/250Vac
6530	TM-1308A	TEND	微動桿微動開關	15A/125/250Vac
24682	TZ-8104	TEND	滑輪搖柄限動開關	AC-12 5A/250VAC
19380	TZ-8108	TEND	小型立式限動開關	AC-15 5A/240VAC
16103	Z-15HW78-B	OMRON	高感度微動開關	15A/250V

小微動開關 Miniature Micro Switch

詳細產品規格--請點擊www.100y.com.tw



DM-00

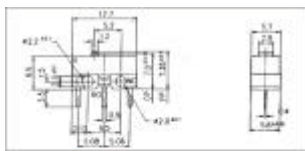

DM-03

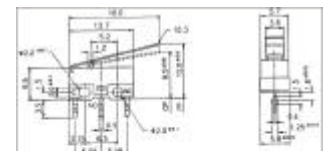

DM-01

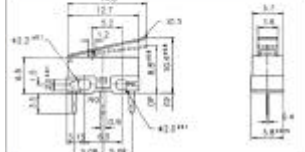

MN4-10-00

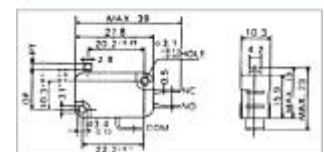

SWITCHES & CONTROL GEAR

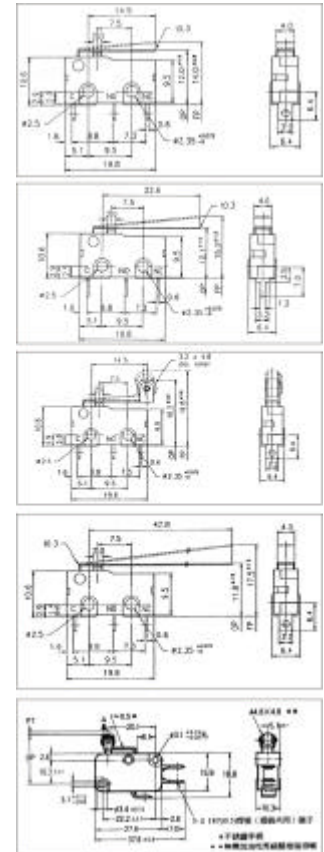
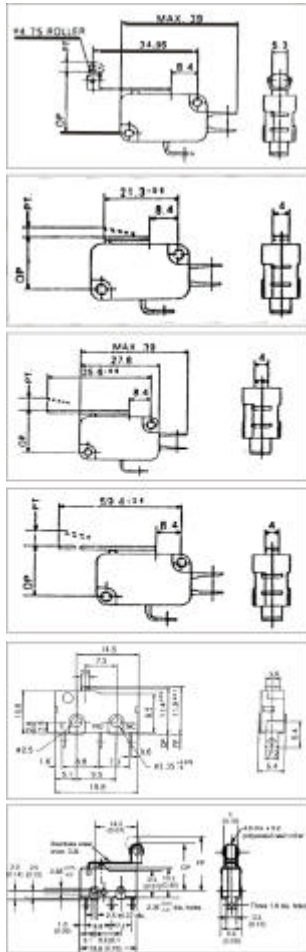

詳細產品規格--請點擊www.100y.com.tw

Part No.	ProductNo.	Manuf.	Description	耐壓電流值
10652	DM-00		微動開關(插板式)	1A/125VAC
5678	DM-01		微動開關(插板式)	1A/125VAC
5677	DM-03		微動開關(插板式)	1A/125VAC
11173	MN4-06-10A		微動開關	125/250V AC 10A
10641	MN4-10-00		微動開關(焊線式)	125/250VAC 10A
26836	S-5GL2	OMRON	小型微動開關	5A/125Vac 3A/250Vac
6666	SM-00		微動開關(焊線式)	3A/125/250Vac
4239	SM-01-5A		微動開關(焊線式) UL	3A/125/250Vac
4238	SM-03		微動開關(焊線式)	5A/125/250Vac
6665	SM-05		短微動開關UL	125/5A
11172	SM-07		微動開關(焊線式)	3A/125/250Vac
16921	SS-5GL2	OMRON	小型微動開關	5A/125Vac 3A/250Vac
13195	V-105-1A5		短輪型微動開關	125VDC/0.3-0.6A
10642	VM-01		微動開關(焊線式)	
10643	VM-02		微動開關(焊線式)	
10644	VM-03		微動開關(焊線式)	

微動開關附扣押 Push-Button Assemblies

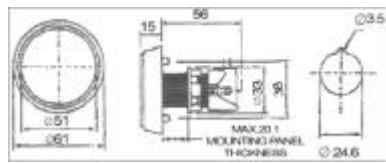

詳細產品規格--請點擊www.100y.com.tw

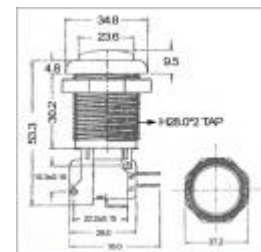
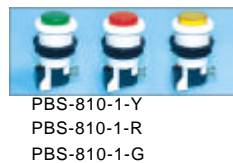

詳細產品規格--請點擊www.100y.com.tw



SWITCHES & CONTROL GEAR



PBS-910-1-R PBS-910-1-BU
PBS-910-1-G
PBS-910-1-Y

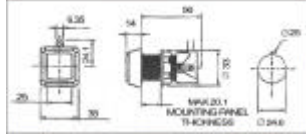
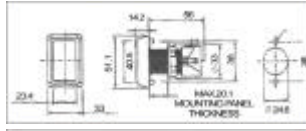

PBS-910-2-R
PBS-910-2-G
PBS-910-2-Y



PBS-910-5-R
PBS-910-5-G
PBS-910-5-Y

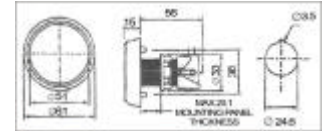

PBS-910-6-R
PBS-910-6-G
PBS-910-6-Y

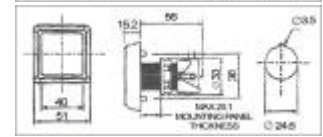

Part No.	ProductNo.	Description	耐壓/電流值	ButtonColor
4506	5092	焊線式		紅色
8585	PBS-810-1-G	按鈕開關綠色電玩圓型	3A/250Vac	綠色
8584	PBS-810-1-R	按鈕開關電玩圓型	3A/250Vac	紅色
8583	PBS-810-1-Y	按鈕開關電玩圓型	3A/250Vac	黃色
21388	PBS-910-1-BU	附燈泡12V按鈕開關藍色小圓型	3A/250Vac	藍色
6062	PBS-910-1-G	附燈泡12V按鈕開關綠色小圓型	3A/250Vac	綠色
8561	PBS-910-1-R	附燈泡12V按鈕開關紅色小圓型	3A/250Vac	紅色
8563	PBS-910-1-Y	附燈泡12V按鈕開關黃色小圓型	3A/250Vac	黃色
8579	PBS-910-2-G	附燈泡12V按鈕開關小方型	3A/250V	綠色
8578	PBS-910-2-R	附燈泡12V按鈕開關小方型	3A/250V	紅色
8577	PBS-910-2-Y	附燈泡12V按鈕開關小方型	3A/250V	黃色
8560	PBS-910-5-G	附燈泡12V按鈕開關大圓型	3A/250V	綠色
6063	PBS-910-5-R	附燈泡12V按鈕開關大圓型	3A/250V	紅色
8562	PBS-910-5-Y	附燈泡12V按鈕開關大圓型	3A/250V	黃色
8582	PBS-910-6-G	附燈泡12V按鈕開關大方型	3A/250V	綠色
8581	PBS-910-6-R	附燈泡12V按鈕開關大方型	3A/250V	紅色
8580	PBS-910-6-Y	附燈泡12V按鈕開關大方型	3A/250V	黃色

主電源開關 電源開關

PowerSwitches

詳細產品規格--請點擊www.100y.com.tw



WNF5001

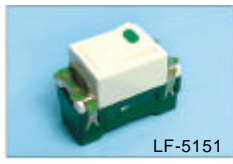

LF-5151



976A



5153



0865

PartNo.	ProductNo.	Description
12238	0865	高級電鈴押扣 大型
10957	5153	電鈴押扣方形
7812	976A	平開關檢驗品
12100	LF-5151	螢光埋入單切開關 15A
4530	WNF5001	電源單切開關

其它開關系列 其它開關類

OtherTypeSwitches

詳細產品規格--請點擊www.100y.com.tw

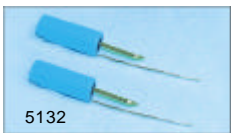

5132

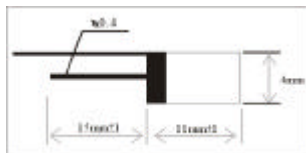

SHL-Q2255

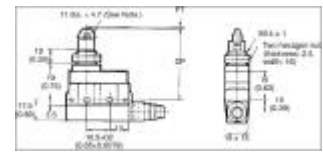

PartNo.	ProductNo.	Description
10640	5132	震動開關 4mm*11mm
28235	GPF521221	OMRON Enclosed Switch
28236	PF52E10	
19484	SHL-Q2255	

