

勝特力材料 886-3-5753170  
勝特力电子(上海) 86-21-34970699  
勝特力电子(深圳) 86-755-83298787  
Http://www.100y.com.tw

**SPECIFICATIONS**

(Typical values for batteries stored at 20°C for one year)

Nominal Capacity(At 1mA/20°C/68°F/2.0V Cut-Off)	1.2 Ah
Open Circuit Voltage(At 20°C/68°F)	3.67 V
Nominal Voltage(At 1mA/20°C/68°F)	3.5 V
Maximum Continuous Current	50 mA
Maximum Pulse Current Capability	100 mA
Rated 1 Sec. Pulse Capability(To 3V)	20 mA
Operating Temperature Range	-55 ~ 85 °C
Weight	9.2 g(0.324 oz)
Anode Surface Area	6 cm <sup>2</sup>
Volume	4.3 cm <sup>3</sup>
Diameter(Max) or L X I	14.5 mm
Height(Max)	25.2 mm

Dimensions in mm

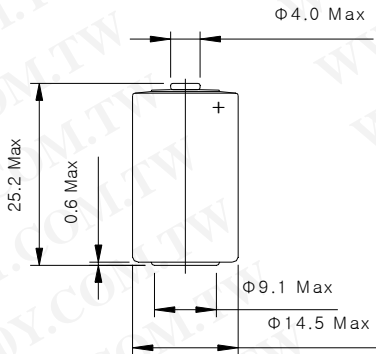

**WARNING**  
Fire, Explosion And Severe Burn Hazard.  
Do Not Recharge, Crush, Disassemble,  
Heat Above 212°F(100°C), Incinerate  
Or Expose Contents To Water

Voltage(V) DISCHARGE CHARACTERISTICS AT +20°C

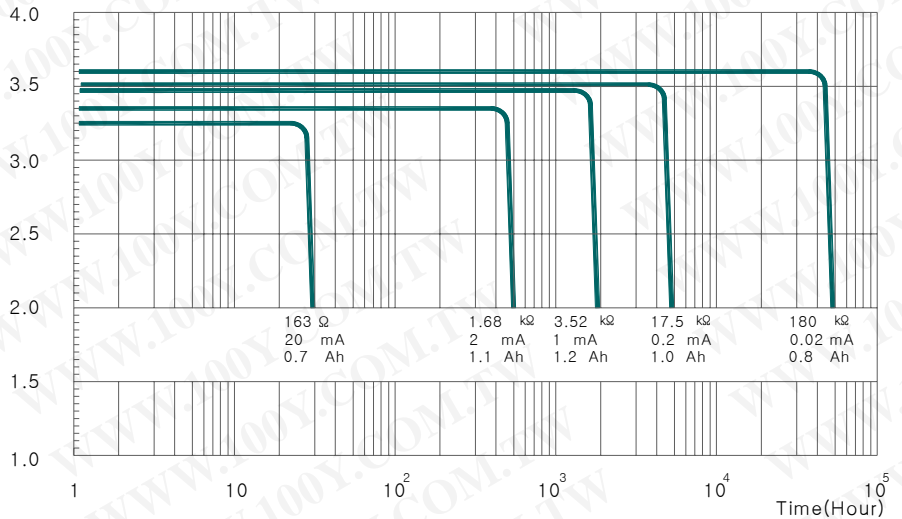

CAPACITY vs. CURRENT

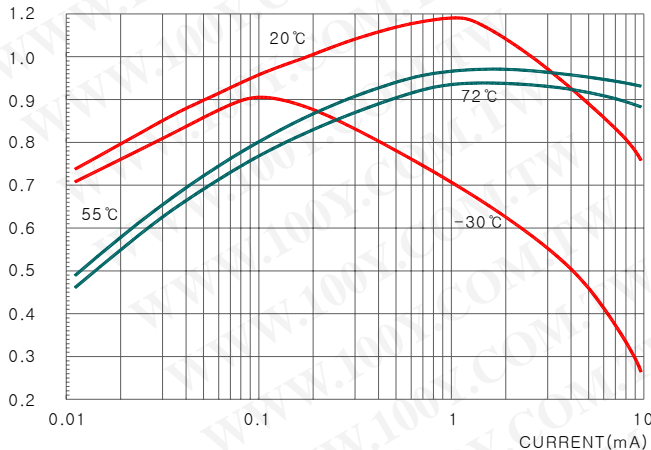

Voltage(V) TEMPERATURE vs. OPERATING VOLTAGE

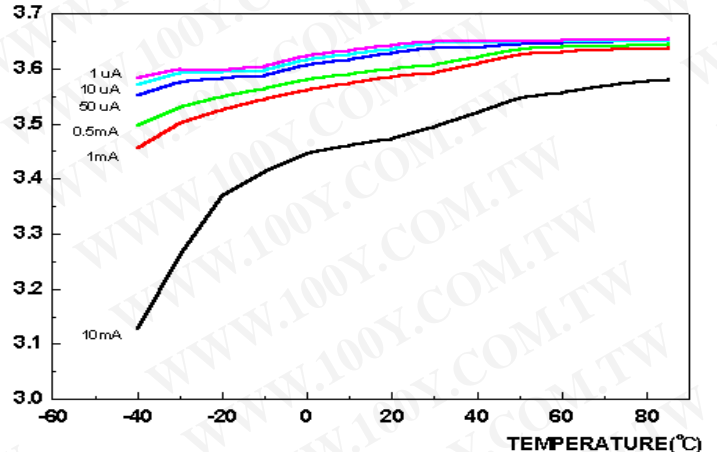



Thionyl Chloride Lithium Battery

# XL-050F

SIZE/ANSI: 1/2AA, ER14252



勝特力材料 886-3-5753170  
 勝特力电子(上海) 86-21-34970699  
 勝特力电子(深圳) 86-755-83298787  
 Http://www.100y.com.tw

### 规格

(电池在20°C条件下存放1年)

标称容量 (1mA放电、20°C、终止电压2V)	1.2Ah
标称电压	3.6V
最大连续放电电流	50mA
最大脉冲放电电流	100mA
工作温度范围	-55~85°C
重量	9g
体积	4.3cm <sup>3</sup>
UL认证	MH28122

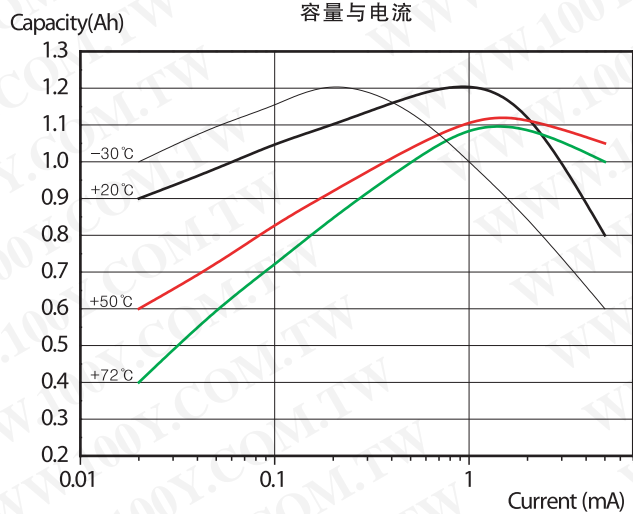
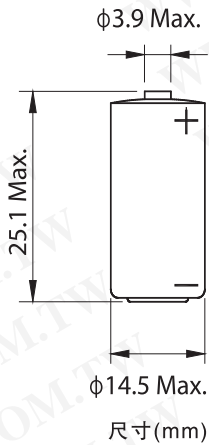
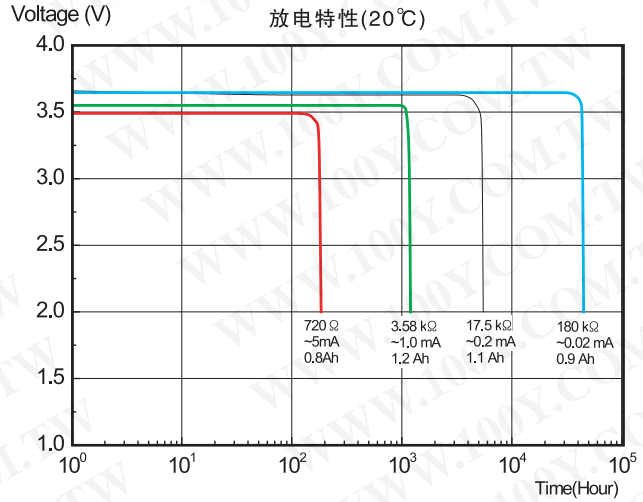

**注意:**  
 严禁焚烧电池和对电池充电。  
 不要对电池短路、解剖、碾压，或置于水中，电池使用环境温度不能超过100°C，不能直接在电池正负极上焊锡。

