

勝特力材料 886-3-5753170
勝特力电子(上海) 86-21-34970699
勝特力电子(深圳) 86-755-83298787
Http://www.100y.com.tw

SPECIFICATIONS

(Typical values for batteries stored at 20°C for one year)

Nominal Capacity(At 5mA/20°C/68°F/2.0V Cut-Off)	16.5 Ah
Open Circuit Voltage(At 20°C/68°F)	3.67 V
Nominal Voltage(At 5mA/20°C/68°F)	3.5 V
Maximum Continuous Current	230 mA
Maximum Pulse Current Capability	500 mA
Rated 1 Sec. Pulse Capability(To 3V)	100 mA
Operating Temperature Range	-55 ~ 85 °C
Weight	92.5 g(3.26 oz)
Anode Surface Area	40 cm ²
Volume	51 cm ³
Diameter(Max) or L X I	33.6 mm
Height(Max)	60 mm

Dimemions in mm
Φ4.0 Max

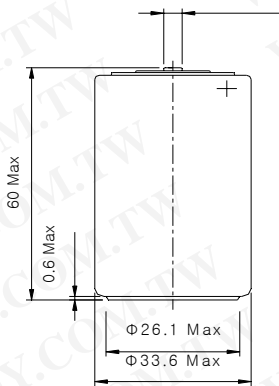

WARNING
Fire, Explosion And Severe Burn Hazard.
Do Not Recharge, Crush, Disassemble,
Heat Above 212°F(100°C), Incinerate
Or Expose Contents To Water

Voltage(V) DISCHARGE CHARACTERISTICS AT +20°C

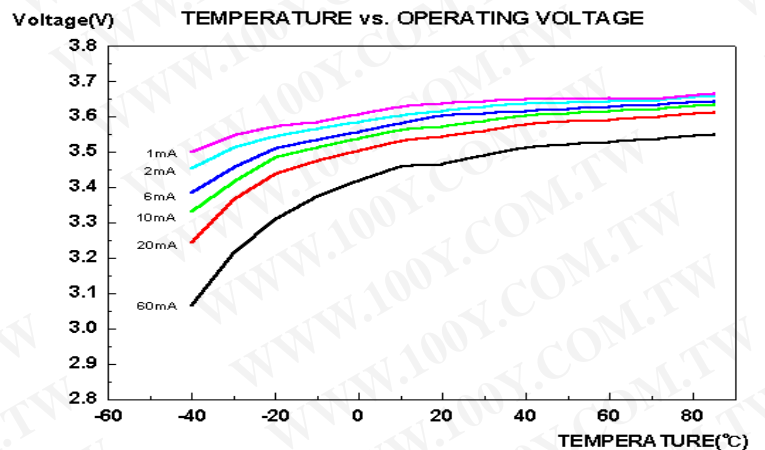
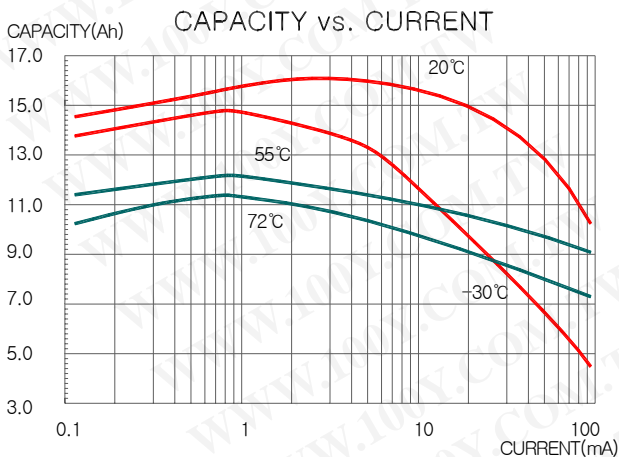
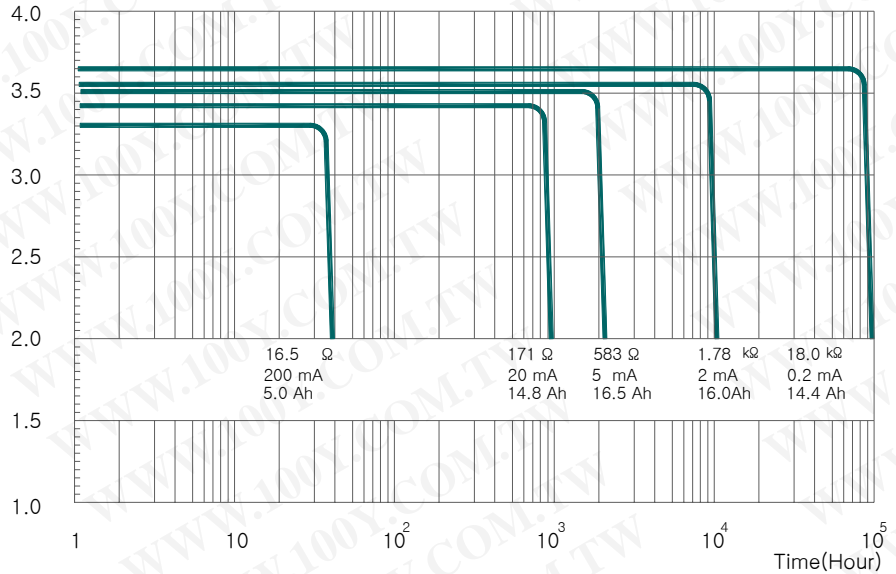



Thionyl Chloride Lithium Battery

XL-200F

SIZE/ANSI: D, ER32L615



勝特力材料 886-3-5753170
 勝特力电子(上海) 86-21-34970699
 勝特力电子(深圳) 86-755-83298787
 Http://www.100y.com.tw

规格

(电池在20°C条件下存放1年)

标称容量 (5mA放电、20°C、终止电压2V)	16.5Ah
标称电压	3.6V
最大连续放电电流	230mA
最大脉冲放电电流	500mA
工作温度范围	-55~85°C
重量	92g
体积	51.0cm ³
UL认证	MH28122

放电特性(20°C)

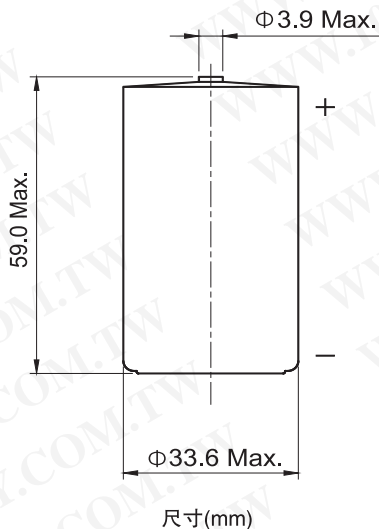
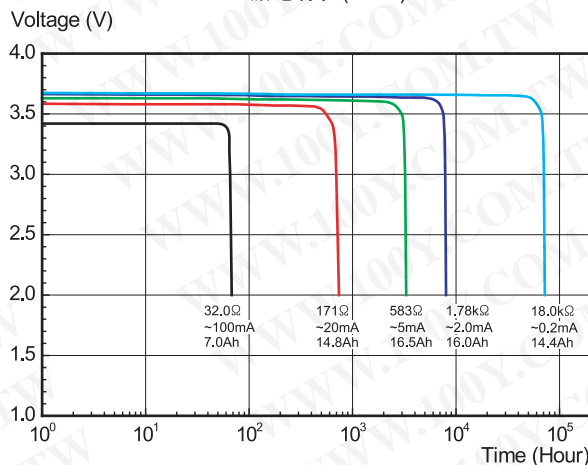

容量与电流

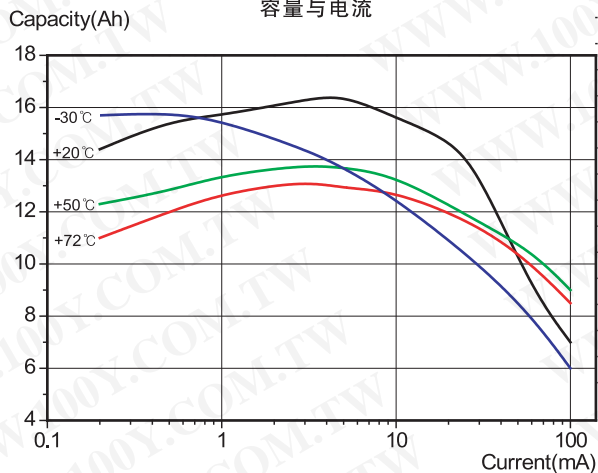

工作电压

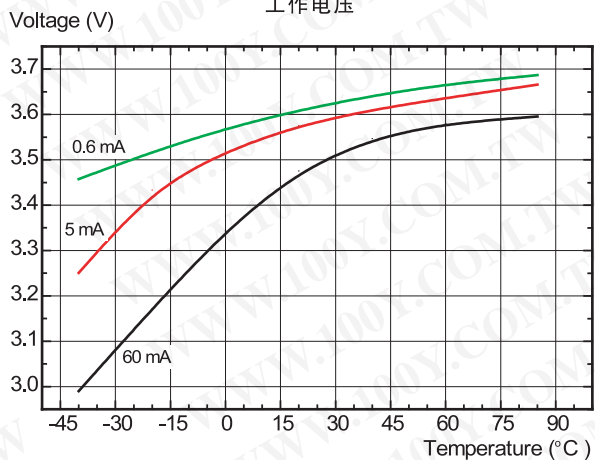

注意:
 严禁焚烧电池和对电池充电。不要对电池短路、解剖、碾压,或置于水中,电池使用环境温度不能超过100°C,不能直接在电池正负极上焊锡。