

7A, 650V N-CHANNEL MOSFET

GENERAL DESCRIPTION

SVF7N65T/F is an N-channel enhancement mode power MOS field effect transistor which is produced using Silan proprietary F-Cell™ structure VDMOS technology. The improved planar stripe cell and the improved guard ring terminal have been especially tailored to minimize on-state resistance, provide superior switching performance, and withstand high energy pulse in the avalanche and commutation mode.

These devices are widely used in AC-DC power suppliers, DC-DC converters and H-bridge PWM motor drivers.

FEATURES

- * 7A,650V, $R_{DS(on)(typ)}=1.1\ \Omega@V_{GS}=10V$
- * Low gate charge
- * Low Crss
- * Fast switching
- * Improved dv/dt capability

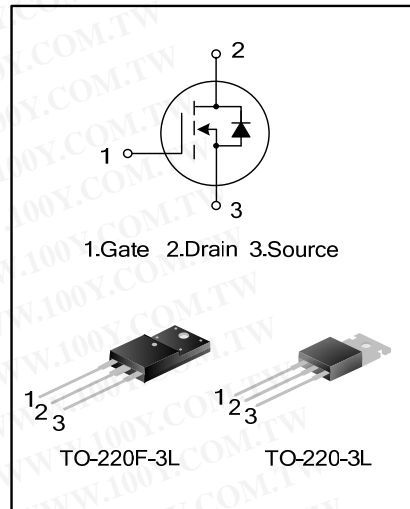

勝特力材料 886-3-5753170
 勝特力电子(上海) 86-21-34970699
 勝特力电子(深圳) 86-755-83298787
[Http://www.100y.com.tw](http://www.100y.com.tw)

NOMENCLATURE

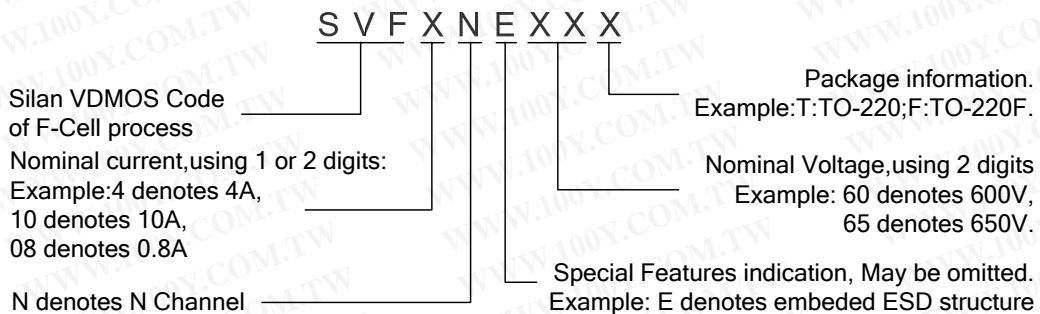

ORDERING INFORMATION

Part No.	Package	Marking	Material	Packing
SVF7N65T	TO-220-3L	SVF7N65T	Pb free	Tube
SVF7N65F	TO-220F-3L	SVF7N65F	Pb free	Tube

ABSOLUTE MAXIMUM RATINGS ($T_C=25^\circ\text{C}$ unless otherwise noted)

Characteristics	Symbol	Ratings		Unit
		SVF7N65T	SVF7N65F	
Drain-Source Voltage	V_{DS}	650		V
Gate-Source Voltage	V_{GS}	± 30		V
Drain Current	I_D	$T_C = 25^\circ\text{C}$		A
		$T_C = 100^\circ\text{C}$		
Drain Current Pulsed	I_{DM}	28		A
Power Dissipation($T_C=25^\circ\text{C}$) -Derate above 25°C	P_D	145	46	W
		1.16	0.37	W/ $^\circ\text{C}$
Single Pulsed Avalanche Energy (Note 1)	E_{AS}	435		mJ
Operation Junction Temperature Range	T_J	$-55 \sim +150$		$^\circ\text{C}$
Storage Temperature Range	T_{stg}	$-55 \sim +150$		$^\circ\text{C}$

THERMAL CHARACTERISTICS

Characteristics	Symbol	Ratings		Unit
		SVF7N65T	SVF7N65F	
Thermal Resistance, Junction-to-Case	$R_{\theta JC}$	0.86	2.7	$^\circ\text{C}/\text{W}$
Thermal Resistance, Junction-to-Ambient	$R_{\theta JA}$	62.5	120	$^\circ\text{C}/\text{W}$

ELECTRICAL CHARACTERISTICS ($T_C=25^\circ\text{C}$ unless otherwise noted)

Characteristics	Symbol	Test conditions	Min.	Typ.	Max.	Unit
Drain -Source Breakdown Voltage	B_{VDSS}	$V_{GS}=0\text{V}, I_D=250\mu\text{A}$	650	--	--	V
Drain-Source Leakage Current	I_{DSS}	$V_{DS}=650\text{V}, V_{GS}=0\text{V}$	--	--	10	μA
Gate-Source Leakage Current	I_{GSS}	$V_{GS}=\pm 30\text{V}, V_{DS}=0\text{V}$	--	--	± 100	nA
Gate Threshold Voltage	$V_{GS(th)}$	$V_{GS}=V_{DS}, I_D=250\mu\text{A}$	2.0	--	4.0	V
Static Drain- Source On State Resistance	$R_{DS(on)}$	$V_{GS}=10\text{V}, I_D=3.5\text{A}$	--	1.1	1.4	Ω
Input Capacitance	C_{iss}	$V_{DS}=25\text{V}, V_{GS}=0\text{V},$ $f=1.0\text{MHZ}$	--	917.7	--	pF
Output Capacitance	C_{oss}		--	98.6	--	
Reverse Transfer Capacitance	C_{rss}		--	1.90	--	
Turn-on Delay Time	$t_{d(on)}$	$V_{DD}=10\text{V}, R_G=25\Omega, I_D=7.0\text{A}$ (Note 2,3)	--	29.00	--	ns
Turn-on Rise Time	t_r		--	48.00	--	
Turn-off Delay Time	$t_{d(off)}$		--	39.00	--	
Turn-off Fall Time	t_f		--	33.00	--	
Total Gate Charge	Q_g	$V_{DS}=520\text{V}, I_D=7.0\text{A},$ $V_{GS}=10\text{V}$ (Note 2,3)	--	15.50	--	nC
Gate-Source Charge	Q_{gs}		--	5.40	--	
Gate-Drain Charge	Q_{gd}		--	4.50	--	

SOURCE-DRAIN DIODE RATINGS AND CHARACTERISTICS

Characteristics	Symbol	Test conditions	Min.	Typ.	Max.	Unit
Continuous Source Current	I_S	Integral Reverse P-N Junction Diode in the MOSFET	--	--	7.0	A
Pulsed Source Current	I_{SM}		--	--	28.0	
Diode Forward Voltage	V_{SD}	$I_S=7.0A, V_{GS}=0V$	--	--	1.4	V
Reverse Recovery Time	T_{rr}	$I_S=7.0A, V_{GS}=0V,$	--	365	--	ns
Reverse Recovery Charge	Q_{rr}	$dI/dt=100A/\mu S$ (Note 2)	--	3.4	--	μC

Notes:

1. $L=30mH, I_{AS}=5.0A, V_{DD}=100V, R_G=25\Omega,$ starting $T_J=25^\circ C$;
2. Pulse Test: Pulse width $\leq 300\mu s,$ Duty cycle $\leq 2\%$;
3. Essentially independent of operating temperature.

TYPICAL CHARACTERISTICS

Figure 1. On-Region Characteristics

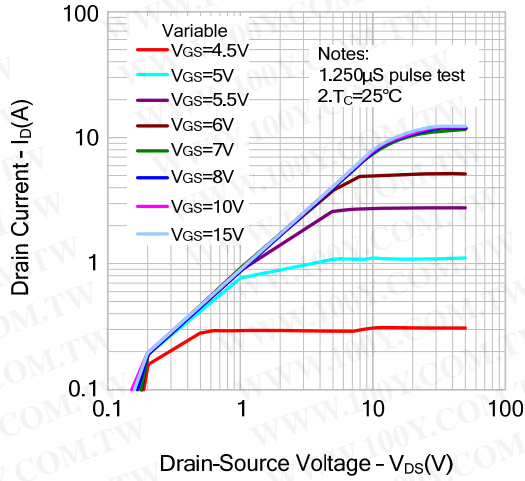

Figure 2. Transfer Characteristics

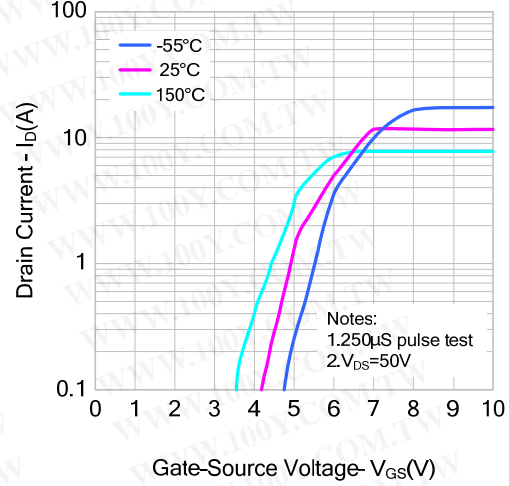

Figure 3. On-Resistance Variation vs. Drain Current and Gate Voltage

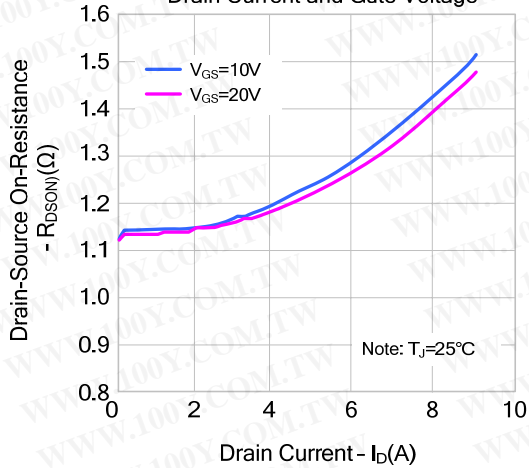

Figure 4. Body Diode Forward Voltage Variation vs. Source Current and Temperature

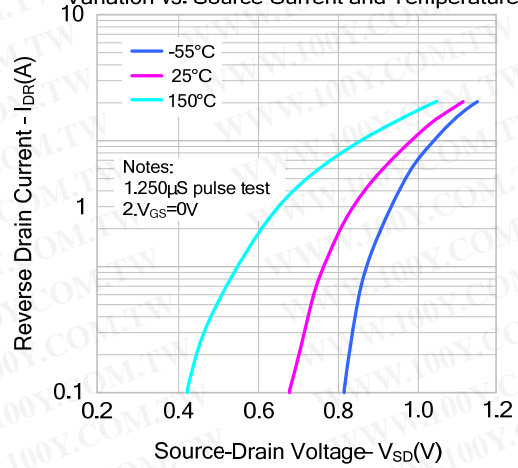

Figure 5. Capacitance Characteristics

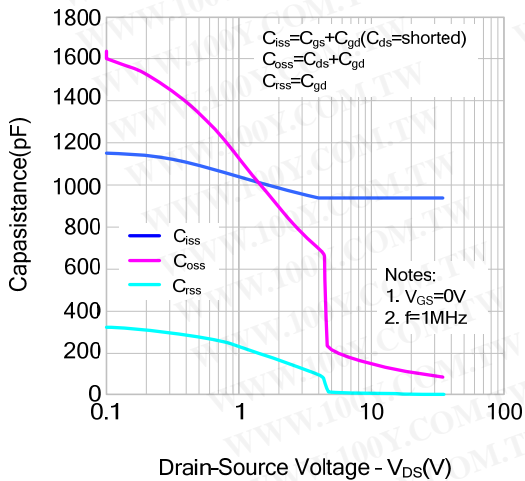
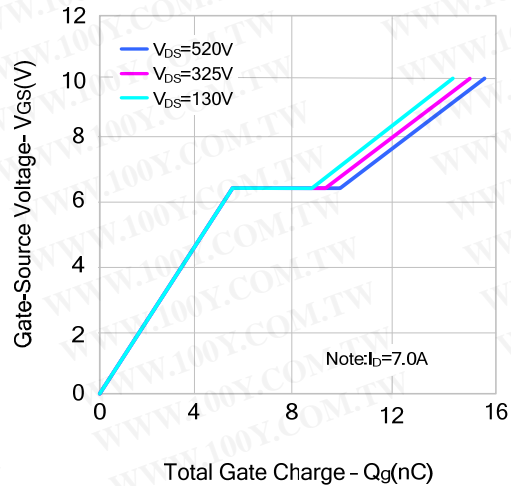
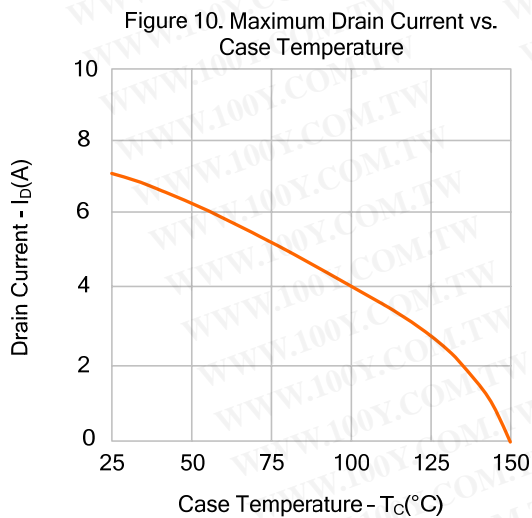
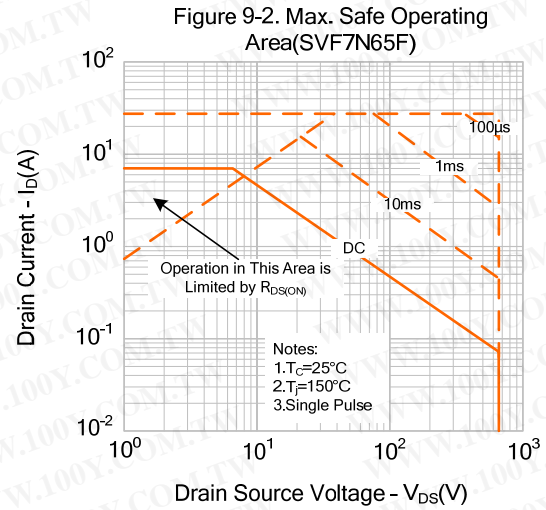
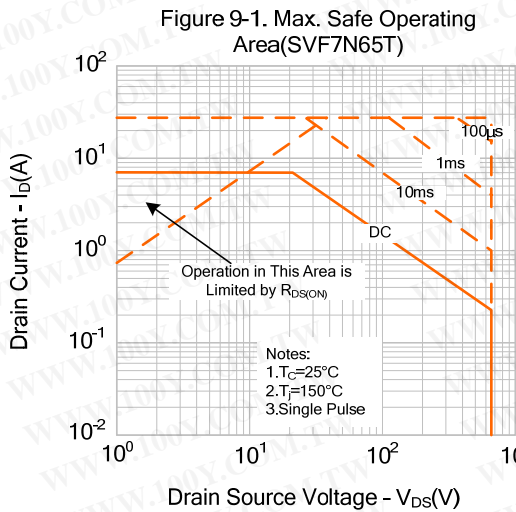
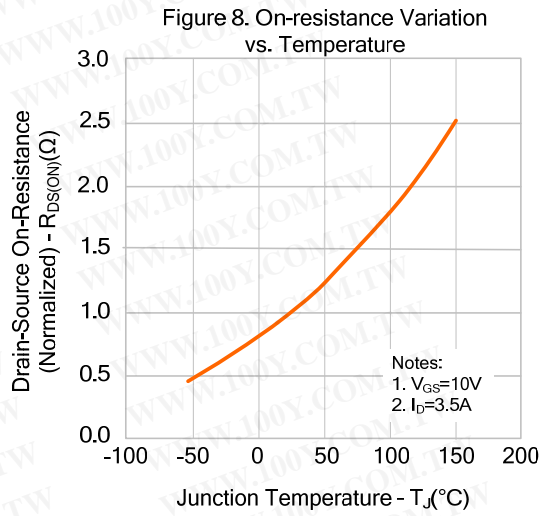
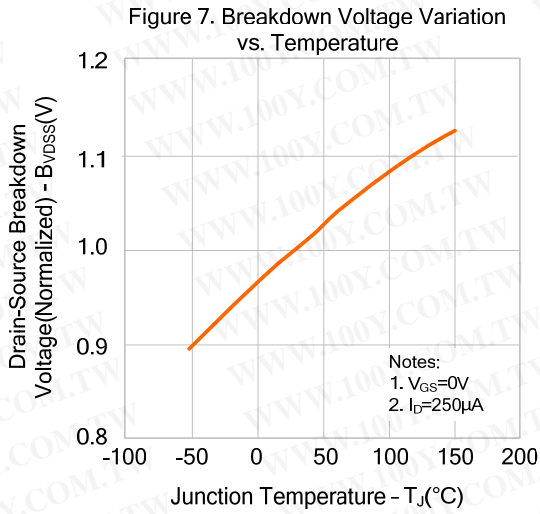

Figure 6. Gate Charge Characteristics



TYPICAL CHARACTERISTICS(continued)



TYPICAL TEST CIRCUIT

Gate Charge Test Circuit & Waveform

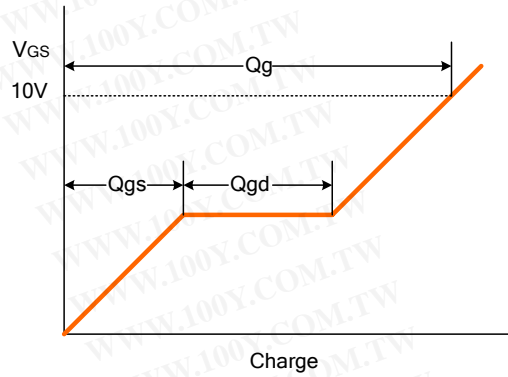
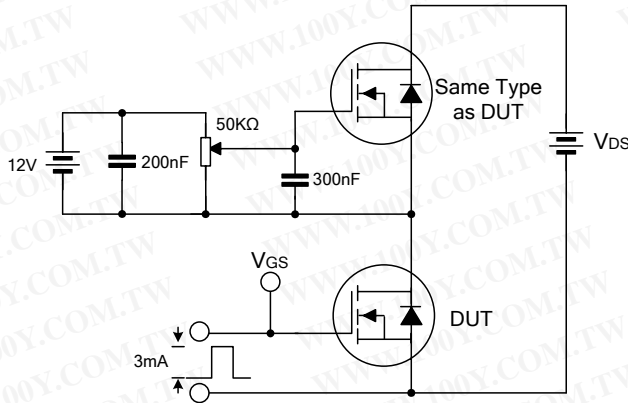

Resistive Switching Test Circuit & Waveform

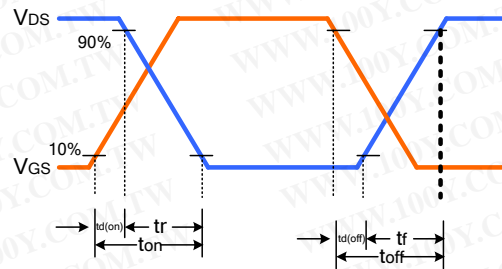
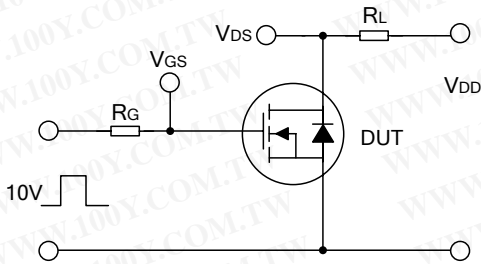

Unclamped Inductive Switching Test Circuit & Waveform

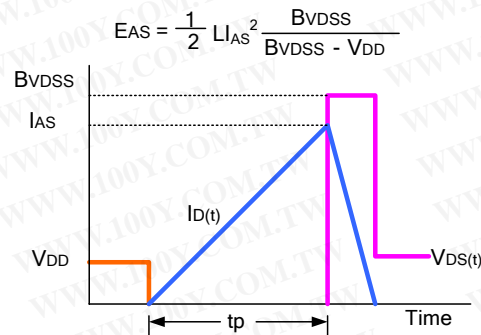
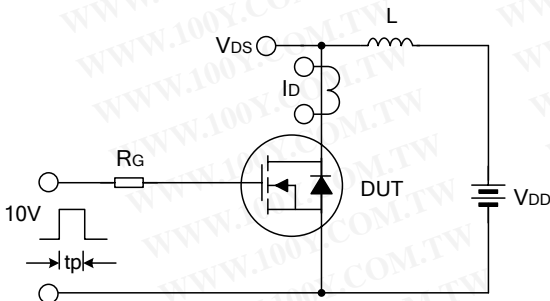

PACKAGE OUTLINE

TO-220-3L

UNIT: mm

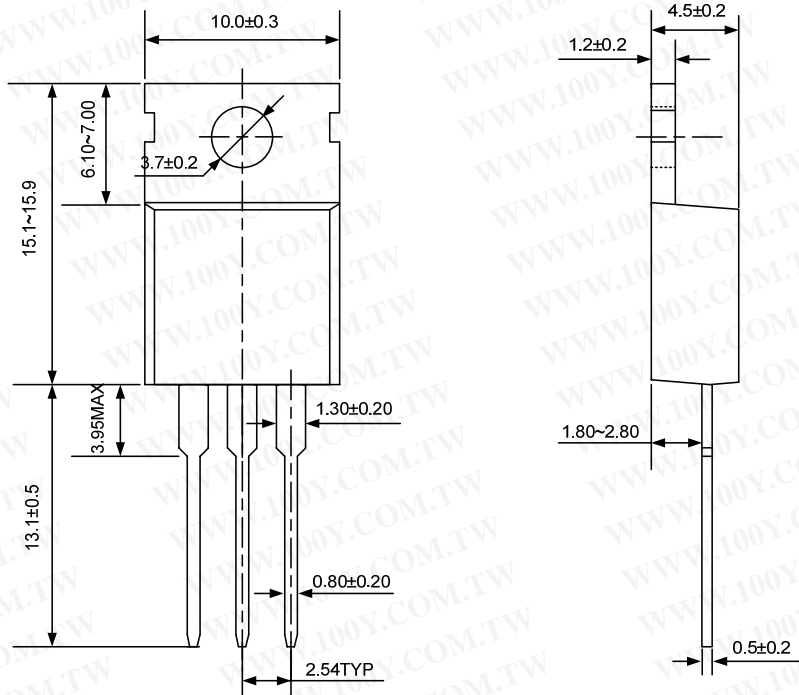

TO-220F-3L

UNIT: mm

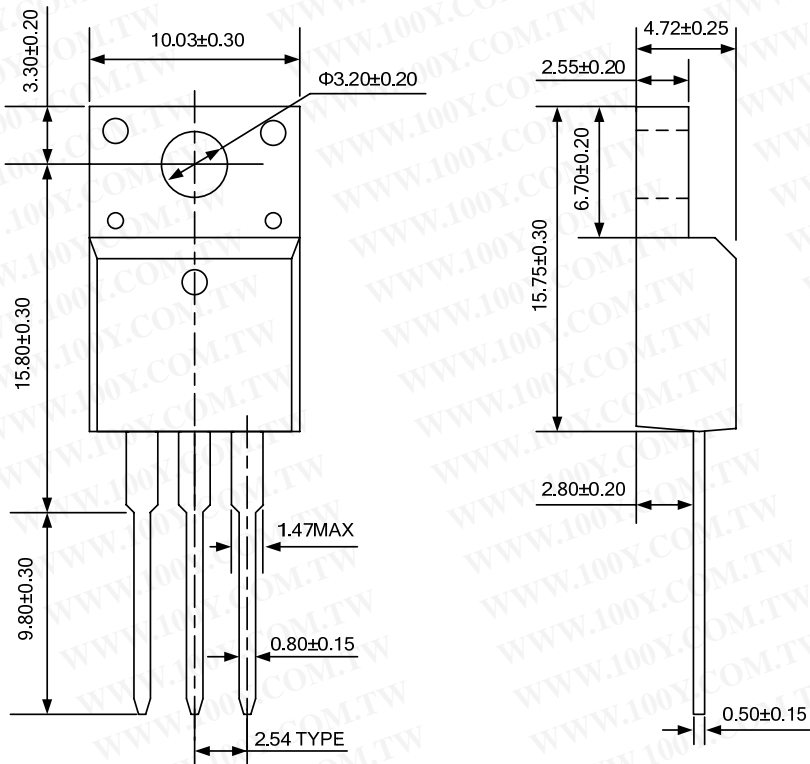



Disclaimer:

- Silan reserves the right to make changes to the information herein for the improvement of the design and performance without further notice! Customers should obtain the latest relevant information before placing orders and should verify that such information is complete and current.
- All semiconductor products malfunction or fail with some probability under special conditions. When using Silan products in system design or complete machine manufacturing, it is the responsibility of the buyer to comply with the safety standards strictly and take essential measures to avoid situations in which a malfunction or failure of such Silan products could cause loss of body injury or damage to property.
- Silan will supply the best possible product for customers!

ATTACHMENT

Revision History

Date	REV	Description	Page
2010.12.13	1.0	Original	
2011.02.15	1.1	Modify "ABSOLUTE MAXIMUM RATINGS" and "ELECTRICAL CHARACTERISTICS"	

勝特力材料 886-3-5753170
勝特力电子(上海) 86-21-34970699
勝特力电子(深圳) 86-755-83298787
[Http://www.100y.com.tw](http://www.100y.com.tw)