

# Datasheet SHT21

## Humidity and Temperature Sensor IC

- Fully calibrated
- Digital output, I<sup>2</sup>C interface
- Low power consumption
- Excellent long term stability
- DFN type package – reflow solderable



### Product Summary

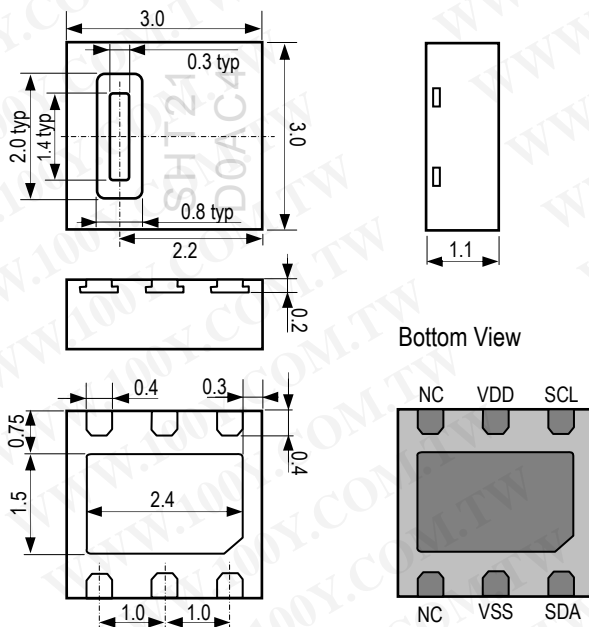
SHT21, the new humidity and temperature sensor of Sensirion is about to set new standards in terms of size and intelligence: Embedded in a reflow solderable Dual Flat No leads (DFN) package of 3 x 3mm foot print and 1.1mm height it provides calibrated, linearized signals in digital, I<sup>2</sup>C format.

With a completely new designed CMOSens® chip, a reworked capacitive type humidity sensor and an improved band gap temperature sensor the performance has been lifted even beyond the outstanding level of the previous sensor generation (SHT1x and SHT7x). For example, measures have been taken to stabilize the behavior at high humidity levels.

Every sensor is individually calibrated and tested. Lot identification is printed on the sensor and an electronic identification code is stored on the chip – which can be read out by command. Furthermore, the resolution of SHT21 can be changed by command (8/12bit up to 12/14bit for RH/T), low battery can be detected and a checksum helps to improve communication reliability.

With made improvements and the miniaturization of the sensor the performance-to-price ratio has been improved – and eventually, any device should benefit from the cutting edge energy saving operation mode. For testing SHT21 a new evaluation Kit EK-H4 is available.

### Dimensions



**Figure 1:** Drawing of SHT21 sensor package, dimensions are given in mm (1mm = 0.039inch), tolerances are  $\pm 0.1$ mm. The die pad (center pad) is internally connected to VSS. The NC pads must be left floating. VSS = GND, SDA = DATA. Numbering of E/O pads starts at lower right corner (indicated by notch in die pad) and goes clockwise (compare Table 2).

### Sensor Chip

SHT21 features a generation 4C CMOSens® chip. Besides the capacitive relative humidity sensor and the band gap temperature sensor, the chip contains an amplifier, A/D converter, OTP memory and a digital processing unit.

### Material Contents

While the sensor itself is made of Silicon the sensors' housing consists of a plated Cu lead-frame and green epoxy-based mold compound. The device is fully RoHS and WEEE compliant, e.g. free of Pb, Cd and Hg.

### Additional Information and Evaluation Kits

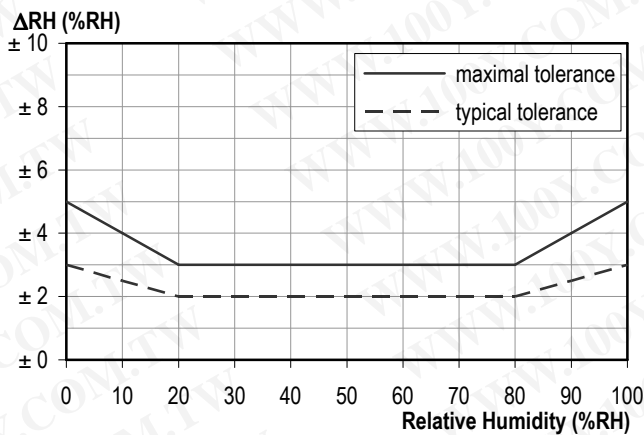
Additional information such as Application Notes is available from the web page [www.sensirion.com/sht21](http://www.sensirion.com/sht21). For more information please contact Sensirion via [info@sensirion.com](mailto:info@sensirion.com).

For SHT21 two Evaluation Kits are available: EK-H4, a four-channel device with Viewer Software, that also serves for data-logging, and a simple EK-H5 directly connecting one sensor via USB port to a computer.

# Sensor Performance

## Relative Humidity

| Parameter                       | Condition             | min          | typ   | max | Units  |
|---------------------------------|-----------------------|--------------|-------|-----|--------|
| Resolution <sup>1</sup>         | 12 bit                |              | 0.04  |     | %RH    |
|                                 | 8 bit                 |              | 0.7   |     | %RH    |
| Accuracy tolerance <sup>2</sup> | typ                   |              | ±2.0  |     | %RH    |
|                                 | max                   | see Figure 2 |       |     | %RH    |
| Repeatability                   |                       |              | ±0.1  |     | %RH    |
| Hysteresis                      |                       |              | ±1    |     | %RH    |
| Nonlinearity                    |                       |              | <0.1  |     | %RH    |
| Response time <sup>3</sup>      | τ 63%                 |              | 8     |     | s      |
| Operating Range                 | extended <sup>4</sup> | 0            |       | 100 | %RH    |
| Long Term Drift <sup>5</sup>    | normal                |              | < 0.5 |     | %RH/yr |



**Figure 2** Typical and maximal tolerance at 25°C for relative humidity. For extensive information see Users Guide, Sect. 1.2.

## Electrical Specification

| Parameter                        | Condition   | min                     | typ  | max | Units |
|----------------------------------|---|-------------------------|------|-----|-------|
| Supply Voltage, VDD              |   | 2.1                     | 3.0  | 3.6 | V     |
| Supply Current, IDD <sup>6</sup> | sleep mode  |                         | 0.15 | 0.4 | μA    |
|                                  | measuring   | 200                     | 300  | 330 | μA    |
| Power Dissipation <sup>6</sup>   | sleep mode  |                         | 0.5  | 1.2 | μW    |
|                                  | measuring   | 0.6                     | 0.9  | 1.0 | mW    |
|                                  | average 8bit  |                         | 3.2  |     | μW    |
| Heater                           | VDD = 3.0 V   | 5.5mW, ΔT = + 0.5-1.5°C |      |     |       |
| Communication                    | digital 2-wire interface, I <sup>2</sup> C protocol |                         |      |     |       |

**Table 1** Electrical specification. For absolute maximum values see Section 4.1 of Users Guide.

<sup>1</sup> Default measurement resolution is 14bit (temperature) / 12bit (humidity). It can be reduced to 12/8bit, 11/11bit or 13/10bit by command to user register.

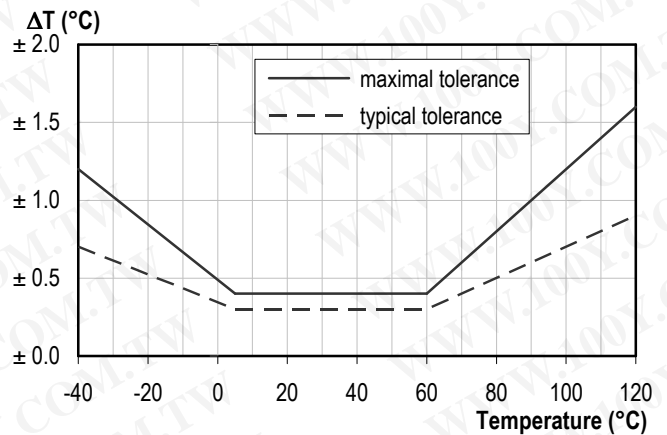
<sup>2</sup> Accuracies are tested at Outgoing Quality Control at 25°C and 3.0V. Values exclude hysteresis and long term drift and are applicable to non-condensing environments only.

<sup>3</sup> Time for achieving 63% of a step function, valid at 25°C and 1m/s airflow.

<sup>4</sup> Normal operating range: 0-80%RH, beyond this limit sensor may read a reversible offset with slow kinetics (+3%RH after 60h at humidity >80%RH). For more details please see Section 1.1 of the Users Guide.

## Temperature

| Parameter                       | Condition             | min          | typ    | max | Units |
|---------------------------------|-----------------------|--------------|--------|-----|-------|
| Resolution <sup>1</sup>         | 14 bit                |              | 0.01   |     | °C    |
|                                 | 12 bit                |              | 0.04   |     | °C    |
| Accuracy tolerance <sup>2</sup> | typ                   |              | ±0.3   |     | °C    |
|                                 | max                   | see Figure 3 |        |     | °C    |
| Repeatability                   |                       |              | ±0.1   |     | °C    |
| Operating Range                 | extended <sup>4</sup> | -40          |        | 125 | °C    |
| Response Time <sup>7</sup>      | τ 63%                 | 5            |        | 30  | s     |
| Long Term Drift                 |                       |              | < 0.04 |     | °C/yr |



**Figure 3** Typical and maximal tolerance for temperature sensor in °C.

## Packaging Information

| Sensor Type | Packaging   | Quantity | Order Number |
|-------------|-------------|----------|--------------|
| SHT21       | Tape & Reel | 400      | 1-100707-01  |
|             | Tape & Reel | 1500     | 1-100645-01  |
|             | Tape & Reel | 5000     | 1-100694-01  |

This datasheet is subject to change and may be amended without prior notice.

<sup>5</sup> Value may be higher in environments with vaporized solvents, out-gassing tapes, adhesives, packaging materials, etc. For more details please refer to Handling Instructions.

<sup>6</sup> Min and max values of Supply Current and Power Dissipation are based on fixed VDD = 3.0V and T<60°C. The average value is based on one 8bit measurement per second.

<sup>7</sup> Response time depends on heat conductivity of sensor substrate.

# Users Guide SHT21

## 1 Extended Specification

For details on how Sensirion is specifying and testing accuracy performance please consult Application Note "Statement on Sensor Specification".

### 1.1 Operating Range

The sensor works stable within recommended Normal Range – see Figure 4. Long term exposure to conditions outside Normal Range, especially at humidity >80%RH, may temporarily offset the RH signal (+3%RH after 60h). After return into the Normal Range it will slowly return towards calibration state by itself. See Section 2.3 "Reconditioning Procedure" for eliminating the offset. Prolonged exposure to extreme conditions may accelerate ageing.

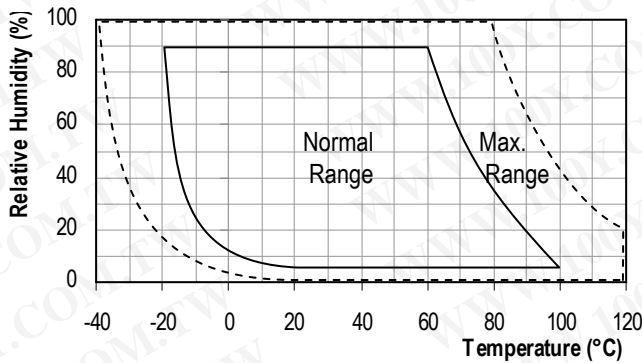


Figure 4 Operating Conditions

### 1.2 RH accuracy at various temperatures

Maximal tolerance for RH accuracy at 25°C is defined in Figure 2. For other temperatures maximal tolerance has been evaluated to be within limits displayed in Figure 5.

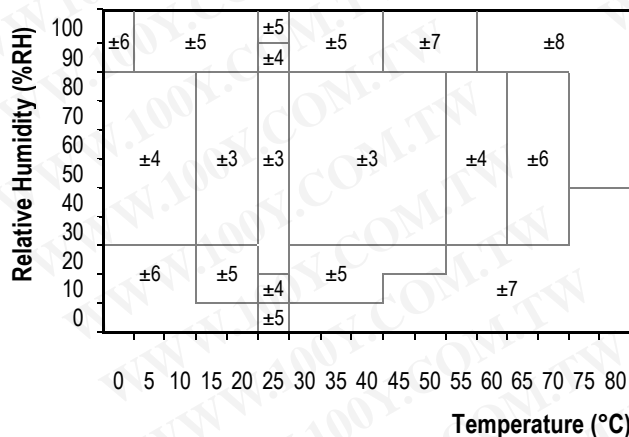


Figure 5 Maximal tolerance of relative humidity measurements given in %RH for temperatures 0 – 80°C.

Please note that above values are maximal tolerances (not including hysteresis) against a high precision reference such as a dew point mirror. Typical deviations are at ±2%RH where maximal tolerance is ±3%RH and about half the maximal tolerance at other values.

### 1.3 Electrical Specification

Current consumption as given in Table 1 is dependent on temperature and supply voltage VDD. For estimations on energy consumption of the sensor Figures 6 and 7 may be consulted. Please note that values given in these Figures are of typical nature and the variance is considerable.

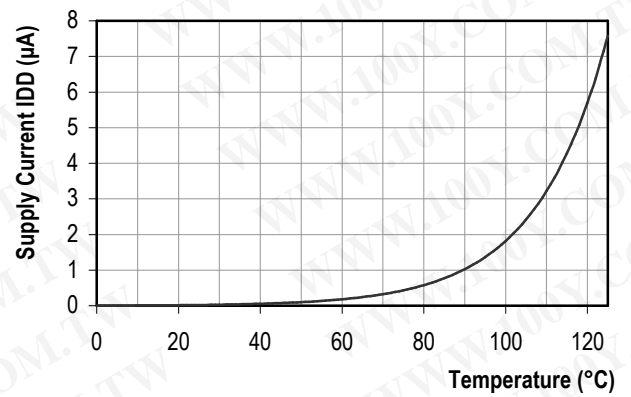


Figure 6 Typical dependency of supply current (sleep mode) versus temperature at VDD = 3.0V. Please note that the variance of these data can be above ±25% of displayed value.

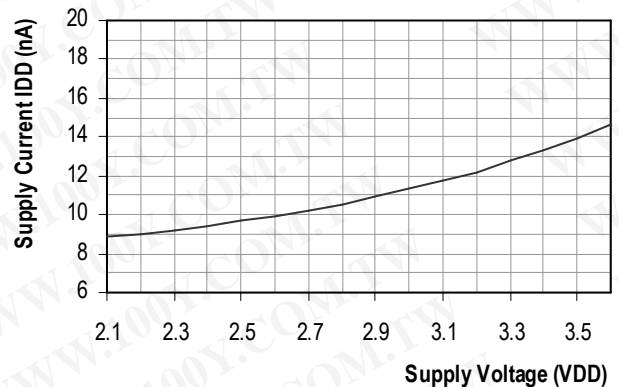


Figure 7 Typical dependency of supply current (sleep mode) versus supply voltage at 25°C. Please note that deviations may be up to ±50% of displayed value. Values at 60°C scale with a factor of about 15 (compare Table 1).

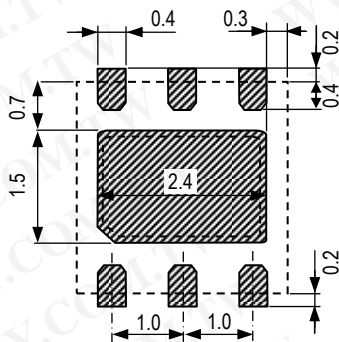
## 2 Application Information

### 2.1 Soldering Instructions

The DFN's die pad (centre pad) and perimeter I/O pads are fabricated from a planar copper lead-frame by over-molding leaving the die pad and I/O pads exposed for mechanical and electrical connection. Both the I/O pads and die pad should be soldered to the PCB. In order to prevent oxidation and optimize soldering, the bottom side of the sensor pads is plated with Ni/Pd/Au.

On the PCB the I/O lands<sup>8</sup> should be 0.2mm longer than the package I/O pads. Inward corners may be rounded to match the I/O pad shape. The I/O land width should match the DFN-package I/O-pads width 1:1 and the land for the die pad should match 1:1 with the DFN package – see Figure 8.

The solder mask<sup>9</sup> design for the land pattern preferably is of type Non-Solder Mask Defined (NSMD) with solder mask openings larger than metal pads. For NSMD pads, the solder mask opening should be about 120µm to 150µm larger than the pad size, providing a 60µm to 75µm design clearance between the copper pad and solder mask. Rounded portions of package pads should have a matching rounded solder mask-opening shape to minimize the risk of solder bridging. For the actual pad dimensions, each pad on the PCB should have its own solder mask opening with a web of solder mask between adjacent pads.

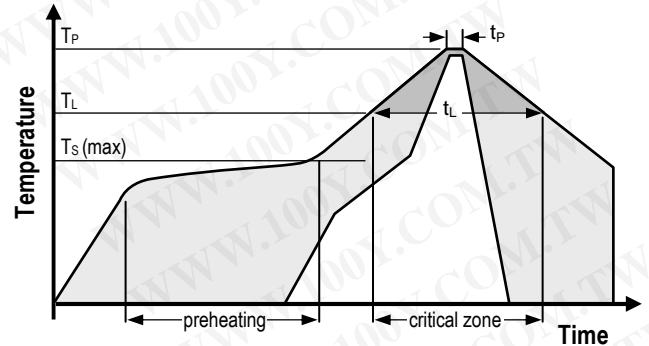


**Figure 8** Recommended metal land pattern for SHT2x. Values in mm. Die pad (centre pad) may be left floating or be connected to ground, NC pads shall be left floating. The outer dotted line represents the outer dimension of the DFN package.

For solder paste printing a laser-cut, stainless steel stencil with electro-polished trapezoidal walls and with 0.125mm stencil thickness is recommended. For the I/O pads the stencil apertures should be 0.1mm longer than PCB pads and positioned with 0.1mm offset away from the centre of the package. The die pad aperture should cover about 70 – 90% of the pad area – say up to 1.4mm x 2.3mm

centered on the thermal land area. It can also be split in two openings.

Due to the low mounted height of the DFN, “no clean” type 3 solder paste<sup>10</sup> is recommended as well as Nitrogen purge during reflow.



**Figure 9** Soldering profile according to JEDEC standard.  $T_P \leq 260^\circ\text{C}$  and  $t_P < 30\text{sec}$  for Pb-free assembly.  $T_L < 220^\circ\text{C}$  and  $t_L < 150\text{sec}$ . Ramp-up/down speeds shall be  $< 5^\circ\text{C}/\text{sec}$ .

It is important to note that the diced edge or side faces of the I/O pads may oxidise over time, therefore a solder fillet may or may not form. Hence there is no guarantee for solder joint fillet heights of any kind.

For soldering SHT2x, standard reflow soldering ovens may be used. The sensor is qualified to withstand soldering profile according to IPC/JEDEC J-STD-020 with peak temperatures at 260°C during up to 30sec for Pb-free assembly in IR/Convection reflow ovens (see Figure 9).

For manual soldering contact time must be limited to 5 seconds at up to 350°C.

**IMPORTANT:** After soldering, the devices should be stored at >75%RH for at least 12h to allow the sensor element to re-hydrate. Otherwise the sensor may read an offset that slowly disappears if exposed to ambient conditions. Alternatively the re-hydration process may be performed at ambient conditions (>40%RH) during more than 5 days.

In no case, neither after manual nor reflow soldering, a board wash shall be applied. Therefore, and as mentioned above, it is strongly recommended to use “no-clean” solder paste. In case of applications with exposure of the sensor to corrosive gases or condensed water (i.e. environments with high relative humidity) the soldering pads shall be sealed (e.g. conformal coating) to prevent loose contacts or short cuts.

### 2.2 Storage Conditions and Handling Instructions

Moisture Sensitivity Level (MSL) is 1, according to IPC/JEDEC J-STD-020. At the same time, it is

<sup>8</sup> The land pattern is understood to be the metal layer on the PCB, onto which the DFN pads are soldered to.

<sup>9</sup> The solder mask is understood to be the insulating layer on top of the PCB covering the connecting lines.

<sup>10</sup> Solder types are related to the solder particle size in the paste: Type 3 covers the size range of 25 – 45 µm (powder type 42).

recommended to further process the sensors within 1 year after date of delivery.

It is of great importance to understand that a humidity sensor is not a normal electronic component and needs to be handled with care. Chemical vapors at high concentration in combination with long exposure times may offset the sensor reading.

For this reason it is recommended to store the sensors in original packaging including the sealed ESD bag at following conditions: Temperature shall be in the range of 10°C – 50°C and humidity at 20 – 60%RH (sensors that are not stored in ESD bags). For sensors that have been removed from the original packaging we recommend to store them in ESD bags made of metal-in PE-HD<sup>11</sup>.

In manufacturing and transport the sensors shall be prevented of high concentration of chemical solvents and long exposure times. Out-gassing of glues, adhesive tapes and stickers or out-gassing packaging material such as bubble foils, foams, etc. shall be avoided. Manufacturing area shall be well ventilated.

For more detailed information please consult the document “*Handling Instructions*” or contact Sensirion.

### 2.3 Reconditioning Procedure

As stated above extreme conditions or exposure to solvent vapors may offset the sensor. The following reconditioning procedure may bring the sensor back to calibration state:

Baking: 100 – 105°C at < 5%RH for 10h  
 Re-Hydration: 20 – 30°C at ~ 75%RH for 12h <sup>12</sup>.

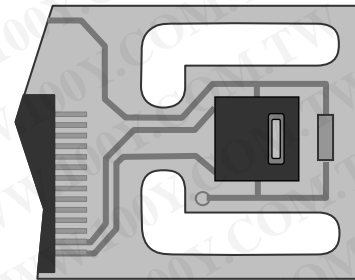
### 2.4 Temperature Effects

Relative humidity reading strongly depends on temperature. Therefore, it is essential to keep humidity sensors at the same temperature as the air of which the relative humidity is to be measured. In case of testing or qualification the reference sensor and test sensor must show equal temperature to allow for comparing humidity readings.

If the sensor shares a PCB with electronic components that produce heat it should be mounted in a way that prevents heat transfer or keeps it as low as possible. Measures to reduce heat transfer can be ventilation, reduction of copper layers between the sensor and the rest of the PCB or milling a slit into the PCB around the sensor – see Figure 10.

Furthermore, there are self-heating effects in case the measurement frequency is too high. To keep self heating below 0.1°C, SHT2x should not be active for more than

10% of the time – e.g. maximum two measurements per second at 12bit accuracy shall be made.



**Figure 10** Top view of example of mounted SHT2x with slits milled into PCB to minimize heat transfer.

### 2.5 Light

The SHT2x is not light sensitive. Prolonged direct exposure to sunshine or strong UV radiation may age the sensor.

### 2.6 Materials Used for Sealing / Mounting

Many materials absorb humidity and will act as a buffer increasing response times and hysteresis. Materials in the vicinity of the sensor must therefore be carefully chosen. Recommended materials are: Any metals, LCP, POM (Delrin), PTFE (Teflon), PEEK, PP, PB, PPS, PSU, PVDF, PVF.

For sealing and gluing (use sparingly): Use high filled epoxy for electronic packaging (e.g. glob top, underfill), and Silicone. Out-gassing of these materials may also contaminate the sensor (see Section 2.2). Therefore try to add the sensor as a last manufacturing step to the assembly, store the assembly well ventilated after manufacturing or bake at >50°C for 24h to outgas contaminants before packing.

### 2.7 Wiring Considerations and Signal Integrity

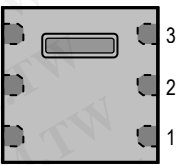
Carrying the SCL and SDA signal parallel and in close proximity (e.g. in wires) for more than 10cm may result in cross talk and loss of communication. This may be resolved by routing VDD and/or VSS between the two SDA signals and/or using shielded cables. Furthermore, slowing down SCL frequency will possibly improve signal integrity. Power supply pins (VDD, VSS) must be decoupled with a 100nF capacitor – see next Section.

<sup>11</sup> For example, 3M antistatic bag, product “1910” with zipper.

<sup>12</sup> 75%RH can conveniently be generated with saturated NaCl solution.

### 3 Interface Specifications

| Pin | Name | Comment                     |
|-----|------|-----------------------------|
| 1   | SDA  | Serial Data, bidirectional  |
| 2   | VSS  | Ground                      |
| 5   | VDD  | Supply Voltage              |
| 6   | SCL  | Serial Clock, bidirectional |
| 3,4 | NC   | Not Connected               |



**Table 2** SHT2x pin assignment, NC remain floating (top view)

#### 3.1 Power Pins (VDD, VSS)

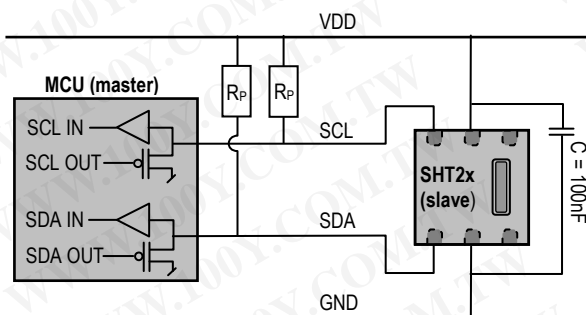
The supply voltage of SHT2x must be in the range of 2.1 – 3.6V, recommended supply voltage is 3.0V. Power supply pins Supply Voltage (VDD) and Ground (VSS) must be decoupled with a 100nF capacitor, that shall be placed as close to the sensor as possible – see Figure 11.

#### 3.2 Serial clock (SCL)

SCL is used to synchronize the communication between microcontroller (MCU) and the sensor. Since the interface consists of fully static logic there is no minimum SCL frequency.

#### 3.3 Serial SDA (SDA)

The SDA pin is used to transfer data in and out of the sensor. For sending a command to the sensor, SDA is valid on the rising edge of SCL and must remain stable while SCL is high. After the falling edge of SCL the SDA value may be changed. For safe communication SDA shall be valid  $t_{SU}$  and  $t_{HD}$  before the rising and after the falling edge of SCL, respectively – see Figure 12. For reading data from the sensor, SDA is valid  $t_{VD}$  after SCL has gone low and remains valid until the next falling edge of SCL.



**Figure 11** Typical application circuit, including pull-up resistors  $R_P$  and decoupling of VDD and VSS by a capacitor.

To avoid signal contention the micro-controller unit (MCU) must only drive SDA and SCL low. External pull-up resistors (e.g. 10k $\Omega$ ), are required to pull the signal high. For the choice of resistor size please take bus capacity requirements into account (compare Table 5). It should be

noted that pull-up resistors may be included in I/O circuits of MCUs. See Table 4 and Table 5 for detailed I/O characteristic of the sensor.

### 4 Electrical Characteristics

#### 4.1 Absolute Maximum Ratings

The electrical characteristics of SHT2x are defined in Table 1. The absolute maximum ratings as given in Table 3 are stress ratings only and give additional information. Functional operation of the device at these conditions is not implied. Exposure to absolute maximum rating conditions for extended periods may affect the sensor reliability (e.g. hot carrier degradation, oxide breakdown).

| Parameter                          | min  | max       | Units |
|------------------------------------|------|-----------|-------|
| VDD to VSS                         | -0.3 | 5         | V     |
| Digital I/O Pins (SDA, SCL) to VSS | -0.3 | VDD + 0.3 | V     |
| Input Current on any Pin           | -100 | 100       | mA    |

**Table 3** Electrical absolute maximum ratings

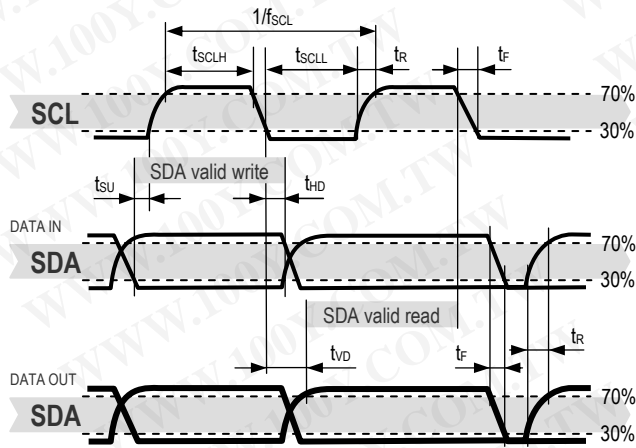
ESD immunity is qualified according to JEDEC JESD22-A114 method (Human Body Model at  $\pm 4kV$ ), JEDEC JESD22-A115 method (Machine Model  $\pm 200V$ ) and ESDA ESD-STM5.3.1-1999 and AEC-Q100-011 (Charged Device Model, 750V corner pins, 500V other pins). Latch-up immunity is provided at a force current of  $\pm 100mA$  with  $T_{amb} = 125^\circ C$  according to JEDEC JESD78. For exposure beyond named limits the sensor needs additional protection circuit.

#### 4.2 Input / Output Characteristics

The electrical characteristics such as power consumption, low and high level input and output voltages depend on the supply voltage. For proper communication with the sensor it is essential to make sure that signal design is strictly within the limits given in Table 4 & 5 and Figure 12.

| Parameter                | Conditions                      | min     | typ | max     | Units   |
|--------------------------|---------------------------------|---------|-----|---------|---------|
| Output Low Voltage, VOL  | VDD = 3.0 V, -4 mA < IOL < 0mA  | 0       | -   | 0.4     | V       |
| Output High Voltage, VOH |                                 | 70% VDD | -   | VDD     | V       |
| Output Sink Current, IOL |                                 | -       | -   | -4      | mA      |
| Input Low Voltage, VIL   |                                 | 0       | -   | 30% VDD | V       |
| Input High Voltage, VIH  |                                 | 70% VDD | -   | VDD     | V       |
| Input Current            | VDD = 3.6 V, VIN = 0 V to 3.6 V | -       | -   | $\pm 1$ | $\mu A$ |

**Table 4** DC characteristics of digital input/output pads. VDD = 2.1V to 3.6V, T = -40°C to 125°C, unless otherwise noted.



**Figure 12** Timing Diagram for Digital Input/Output Pads, abbreviations are explained in Table 5. SDA directions are seen from the sensor. Bold SDA line is controlled by the sensor, plain SDA line is controlled by the micro-controller. Note that SDA valid read time is triggered by falling edge of anterior toggle.

| Parameter                          | min | typ | max | Units   |
|------------------------------------|-----|-----|-----|---------|
| SCL frequency, $f_{SCL}$           | 0   | -   | 0.4 | MHz     |
| SCL High Time, $t_{SCLH}$          | 0.6 | -   | -   | $\mu s$ |
| SCL Low Time, $t_{SCLL}$           | 1.3 | -   | -   | $\mu s$ |
| SDA Set-Up Time, $t_{SU}$          | 100 | -   | -   | ns      |
| SDA Hold Time, $t_{HD}$            | 0   | -   | 900 | ns      |
| SDA Valid Time, $t_{VD}$           | 0   | -   | 400 | ns      |
| SCL/SDA Fall Time, $t_F$           | 0   | -   | 100 | ns      |
| SCL/SDA Rise Time, $t_R$           | 0   | -   | 300 | ns      |
| Capacitive Load on Bus Line, $C_B$ | 0   | -   | 400 | pF      |

**Table 5** Timing specifications of digital input/output pads for I<sup>2</sup>C fast mode. Entities are displayed in Figure 12. VDD = 2.1V to 3.6V, T = -40°C to 125°C, unless otherwise noted. For further information regarding timing, please refer to <http://www.standardics.nxp.com/support/i2c/>.

## 5 Communication with Sensor

SHT21 communicates with I<sup>2</sup>C protocol. For information on I<sup>2</sup>C beyond the information in the following Sections please refer to the following website:

<http://www.standardics.nxp.com/support/i2c/>.

Please note that all sensors are set to the same I<sup>2</sup>C address, as defined in Section 5.3.<sup>13</sup>

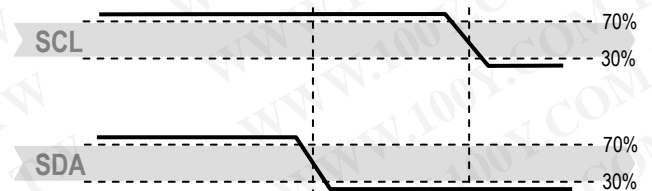
Furthermore, please note, that Sensirion provides an exemplary sample code on its home page – compare [www.sensirion.com/sht21](http://www.sensirion.com/sht21).

### 5.1 Start Up Sensor

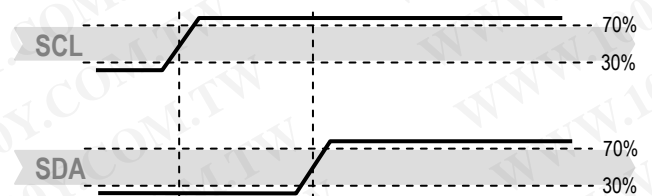
As a first step, the sensor is powered up to the chosen supply voltage VDD (between 2.1V and 3.6V). After power-up, the sensor needs at most 15ms, while SCL is high, for reaching idle state, i.e. to be ready accepting commands from the master (MCU). Current consumption during start up is 350 $\mu$ A maximum. Whenever the sensor is powered up, but not performing a measurement or communicating, it is automatically in idle state (sleep mode).

### 5.2 Start / Stop Sequence

Each transmission sequence begins with Start condition (S) and ends with Stop condition (P) as displayed in Figure 13 and Figure 14.



**Figure 13** Transmission Start condition (S) - a high to low transition on the SDA line while SCL is high. The Start condition is a unique state on the bus created by the master, indicating to the slaves the beginning of a transmission sequence (bus is considered busy after a Start).



**Figure 14** Transmission Stop condition (P) - a low to high transition on the SDA line while SCL is high. The Stop condition is a unique state on the bus created by the master, indicating to the slaves the end of a transmission sequence (bus is considered free after a Stop).

### 5.3 Sending a Command

After sending the Start condition, the subsequent I<sup>2</sup>C header consists of the 7-bit I<sup>2</sup>C device address '1000'000' and an SDA direction bit (Read R: '1', Write W: '0'). The sensor indicates the proper reception of a byte by pulling the SDA pin low (ACK bit) after the falling edge of the 8<sup>th</sup> SCL clock. After the issue of a measurement command ('1110'0011' for temperature, '1110'0101' for relative humidity), the MCU must wait for the measurement to complete. The basic commands are summarized in Table 6.

<sup>13</sup> For sensors with alternative I<sup>2</sup>C address please contact Sensirion via [info@sensirion.com](mailto:info@sensirion.com).

| Command                | Comment        | Code      |
|------------------------|----------------|-----------|
| Trigger T measurement  | hold master    | 1110'0011 |
| Trigger RH measurement | hold master    | 1110'0101 |
| Trigger T measurement  | no hold master | 1111'0011 |
| Trigger RH measurement | no hold master | 1111'0101 |
| Write user register    |                | 1110'0110 |
| Read user register     |                | 1110'0111 |
| Soft reset             |                | 1111'1110 |

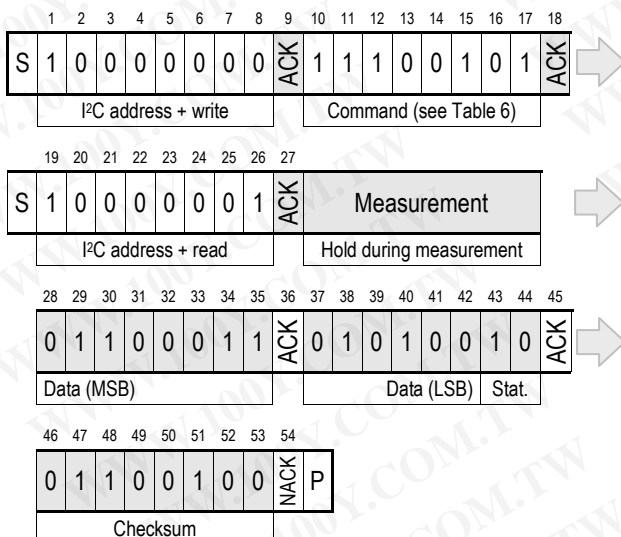
**Table 6** Basic command set, RH stands for relative humidity, and T stands for temperature

Hold master or no hold master modes are explained in next Section.

### 5.4 Hold / No Hold Master Mode

There are two different operation modes to communicate with the sensor: *Hold Master mode* or *No Hold Master mode*. In the first case the SCL line is blocked (controlled by sensor) during measurement process while in the latter case the SCL line remains open for other communication while the sensor is processing the measurement. No hold master mode allows for processing other I<sup>2</sup>C communication tasks on a bus while the sensor is measuring. A communication sequence of the two modes is displayed in Figure 15 and Figure 16, respectively.

In the *hold master mode*, the SHT2x pulls down the SCL line while measuring to force the master into a wait state. By releasing the SCL line the sensor indicates that internal processing is terminated and that transmission may be continued.

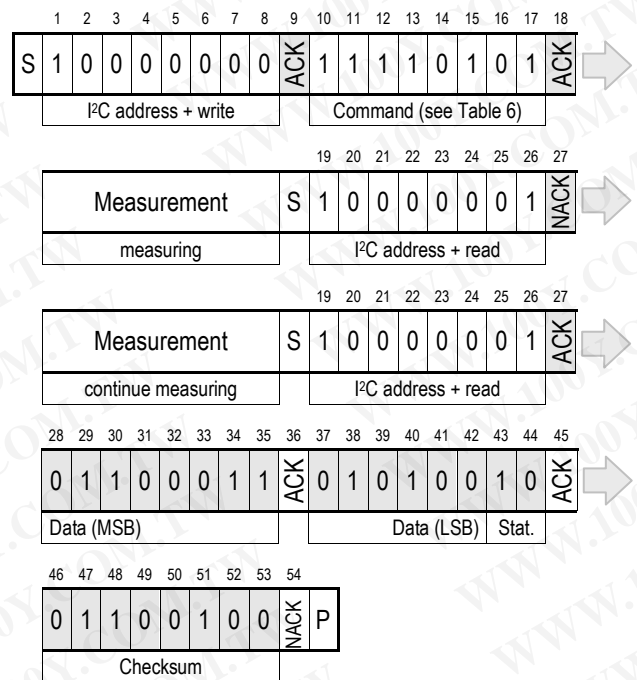


**Figure 15** Hold master communication sequence – grey blocks are controlled by SHT2x. Bit 45 may be changed to NACK followed by Stop condition (P) to omit checksum transmission.

In *no hold master mode*, the MCU has to poll for the termination of the internal processing of the sensor. This is

done by sending a Start condition followed by the I<sup>2</sup>C header (1000'0001) as shown in Figure 16. If the internal processing is finished, the sensor acknowledges the poll of the MCU and data can be read by the MCU. If the measurement processing is not finished the sensor answers no ACK bit and the Start condition must be issued once more.

For both modes, since the maximum resolution of a measurement is 14 bit, the two last least significant bits (LSBs, bits 43 and 44) are used for transmitting status information. Bit 1 of the two LSBs indicates the measurement type ('0': temperature, '1' humidity). Bit 0 is currently not assigned.



**Figure 16** No Hold master communication sequence – grey blocks are controlled by SHT2x. If measurement is not completed upon “read” command, sensor does not provide ACK on bit 27 (more of these iterations are possible). If bit 45 is changed to NACK followed by Stop condition (P) checksum transmission is omitted.

In the examples given in Figure 15 and Figure 16 the sensor output is  $S_{RH} = '0110'0011'0101'0000'$ . For the calculation of physical values Status Bits must be set to '0' – see Chapter 6.

The maximum duration for measurements depends on the type of measurement and resolution chosen – values are displayed in Table 7. Maximum values shall be chosen for the communication planning of the MCU.

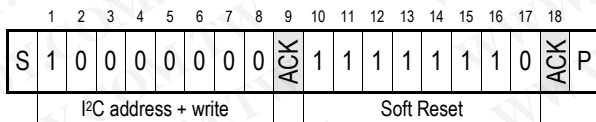
| Resolution | RH typ | RH max | T typ | T max | Units |
|------------|--------|--------|-------|-------|-------|
| 14 bit     |        |        | 66    | 85    | ms    |
| 13 bit     |        |        | 33    | 43    | ms    |
| 12 Bit     | 22     | 29     | 17    | 22    | ms    |
| 11 bit     | 12     | 15     | 9     | 11    | ms    |
| 10 bit     | 7      | 9      |       |       | ms    |
| 8 bit      | 3      | 4      |       |       | ms    |

**Table 7** Measurement times for RH and T measurements at different resolutions. Typical values are recommended for calculating energy consumption while maximum values shall be applied for calculating waiting times in communication.

Please note: I<sup>2</sup>C communication allows for repeated Start conditions (S) without closing prior sequence with Stop condition (P) – compare Figures 15, 16 and 18. Still, any sequence with adjacent Start condition may alternatively be closed with a Stop condition.

### 5.5 Soft Reset

This command (see Table 6) is used for rebooting the sensor system without switching the power off and on again. Upon reception of this command, the sensor system reinitializes and starts operation according to the default settings – with the exception of the heater bit in the user register (see Sect. 5.6). The soft reset takes less than 15ms.



**Figure 17** Soft Reset – grey blocks are controlled by SHT2x.

### 5.6 User Register

The content of User Register is described in Table 8. Please note that reserved bits must not be changed and default values of respective reserved bits may change over time without prior notice. Therefore, for any writing to the User Register, default values of reserved bits must be read first. Thereafter, the full User Register string is composed of respective default values of reserved bits and the remainder of accessible bits optionally with default or non-default values.

The *end of battery* alert is activated when the battery power falls below 2.25V.

The *heater* is intended to be used for functionality diagnosis – relative humidity drops upon rising temperature. The heater consumes about 5.5mW and provides a temperature increase of about 0.5 – 1.5°C.

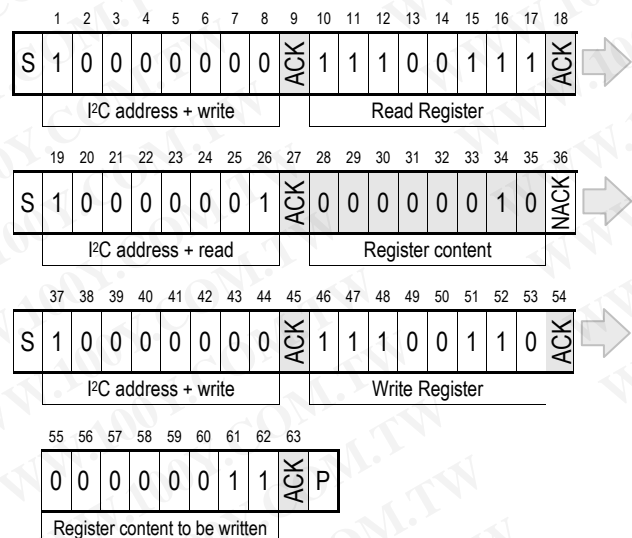
*OTP Reload* is a safety feature and loads the entire OTP settings to the register, with the exception of the heater bit,

before every measurement. This feature is disabled per default and is not recommended for use. Please use Soft Reset instead – it contains OTP Reload.

| Bit     | # Bits | Description / Coding   | Default |    |   |      |        |        |      |       |        |      |        |        |      |        |        |      |
|---------|--------|--|---------|----|---|------|--------|--------|------|-------|--------|------|--------|--------|------|--------|--------|------|
| 7, 0    | 2      | Measurement resolution<br><table border="1"> <thead> <tr> <th></th> <th>RH</th> <th>T</th> </tr> </thead> <tbody> <tr> <td>'00'</td> <td>12 bit</td> <td>14 bit</td> </tr> <tr> <td>'01'</td> <td>8 bit</td> <td>12 bit</td> </tr> <tr> <td>'10'</td> <td>10 bit</td> <td>13 bit</td> </tr> <tr> <td>'11'</td> <td>11 bit</td> <td>11 bit</td> </tr> </tbody> </table> |         | RH | T | '00' | 12 bit | 14 bit | '01' | 8 bit | 12 bit | '10' | 10 bit | 13 bit | '11' | 11 bit | 11 bit | '00' |
|         | RH     | T  |         |    |   |      |        |        |      |       |        |      |        |        |      |        |        |      |
| '00'    | 12 bit | 14 bit   |         |    |   |      |        |        |      |       |        |      |        |        |      |        |        |      |
| '01'    | 8 bit  | 12 bit   |         |    |   |      |        |        |      |       |        |      |        |        |      |        |        |      |
| '10'    | 10 bit | 13 bit   |         |    |   |      |        |        |      |       |        |      |        |        |      |        |        |      |
| '11'    | 11 bit | 11 bit   |         |    |   |      |        |        |      |       |        |      |        |        |      |        |        |      |
| 6       | 1      | Status: End of battery <sup>14</sup><br>'0': VDD > 2.25V<br>'1': VDD < 2.25V   | '0'     |    |   |      |        |        |      |       |        |      |        |        |      |        |        |      |
| 3, 4, 5 | 3      | Reserved   |         |    |   |      |        |        |      |       |        |      |        |        |      |        |        |      |
| 2       | 1      | Enable on-chip heater  | '0'     |    |   |      |        |        |      |       |        |      |        |        |      |        |        |      |
| 1       | 1      | Disable OTP Reload   | '1'     |    |   |      |        |        |      |       |        |      |        |        |      |        |        |      |

**Table 8** User Register. Cut-off value for End of Battery signal may vary by ±0.1V. Reserved bits must not be changed. “OTP reload” = ‘0’ loads default settings after each time a measurement command is issued.

An example for I<sup>2</sup>C communication reading and writing the User Register is given in Figure 18.



**Figure 18** Read and write register sequence – grey blocks are controlled by SHT2x. In this example, the resolution is set to 8bit / 12bit.

### 5.7 CRC Checksum

SHT21 provides a CRC-8 checksum for error detection. The polynomial used is  $x^8 + x^5 + x^4 + 1$ . For more details and implementation please refer to the application note “CRC Checksum Calculation for SHT2x”.

<sup>14</sup> This status bit is updated after each measurement

### 5.8 Serial Number

SHT21 provides an electronic identification code. For instructions on how to read the identification code please refer to the Application Note “Electronic Identification Code” – to be downloaded from the web page [www.sensirion.com/SHT21](http://www.sensirion.com/SHT21).

## 6 Conversion of Signal Output

Default resolution is set to 12 bit relative humidity and 14 bit temperature reading. Measured data are transferred in two byte packages, i.e. in frames of 8 bit length where the most significant bit (MSB) is transferred first (left aligned). Each byte is followed by an acknowledge bit. The two status bits, the last bits of LSB, must be set to ‘0’ before calculating physical values. In the example of Figure 15 and Figure 16, the transferred 16 bit relative humidity data is ‘01110’0011’0101’0000’ = 25424.

### 6.1 Relative Humidity Conversion

With the relative humidity signal output  $S_{RH}$  the relative humidity  $RH$  is obtained by the following formula (result in %RH), no matter which resolution is chosen:

$$RH = -6 + 125 \cdot \frac{S_{RH}}{2^{16}}$$

In the example given in Figure 15 and Figure 16 the relative humidity results to be 42.5%RH.

The physical value  $RH$  given above corresponds to the relative humidity above liquid water according to World Meteorological Organization (WMO). For relative humidity above ice  $RH_i$  the values need to be transformed from relative humidity above water  $RH_w$  at temperature  $t$ . The equation is given in the following, compare also Application Note “Introduction to Humidity”:

$$RH_i = RH_w \cdot \exp\left(\frac{\beta_w \cdot t}{\lambda_w + t}\right) / \exp\left(\frac{\beta_i \cdot t}{\lambda_i + t}\right)$$

Units are %RH for relative humidity and °C for temperature. The corresponding coefficients are defined as follows:  $\beta_w = 17.62$ ,  $\lambda_w = 243.12^\circ\text{C}$ ,  $\beta_i = 22.46$ ,  $\lambda_i = 272.62^\circ\text{C}$ .

### 6.2 Temperature Conversion

The temperature  $T$  is calculated by inserting temperature signal output  $S_T$  into the following formula (result in °C), no matter which resolution is chosen:

$$T = -46.85 + 175.72 \cdot \frac{S_T}{2^{16}}$$

## 7 Environmental Stability

The SHT2x sensor series were tested based on AEC-Q100 Rev. G qualification test method where applicable. Sensor specifications are tested to prevail under the AEC-Q100 temperature grade 2 test conditions listed in Table 9<sup>15</sup>.

| Environment  | Standard   | Results <sup>16</sup> |
|--------------|--|-----------------------|
| HTOL         | 125°C, 408 hours   | Within specifications |
| TC           | -50°C - 125°C, 1000 cycles                                 | Within specifications |
| UHST         | 130°C / 85%RH / ≈2.3bar, 96h                               | Within specifications |
| THB          | 85°C / 85%RH, 1000h  | Within specifications |
| ESD immunity | HBM ±4kV, MM ±200V, CDM 750V/500V (corner/other pins)      | Qualified             |
| Latch-up     | force current of ±100mA with $T_{amb} = 125^\circ\text{C}$ | Qualified             |

**Table 9:** Performed qualification test series. HTOL = High Temperature Operating Lifetime, TC = Temperature Cycles, UHST = Unbiased Highly accelerated Stress Test, THB = Temperature Humidity Biased. For details on ESD see Sect. 4.1.

Sensor performance under other test conditions cannot be guaranteed and is not part of the sensor specifications. Especially, no guarantee can be given for sensor performance in the field or for customer’s specific application.

If sensors are qualified for reliability and behavior in extreme conditions, please make sure that they experience same conditions as the reference sensor. It should be taken into account that response times in assemblies may be longer, hence enough dwell time for the measurement shall be granted. For detailed information please consult Application Note “Testing Guide”.

## 8 Packaging

### 8.1 Packaging Type

SHT2x sensors are provided in DFN packaging (in analogy with QFN packaging). DFN stands for Dual Flat No leads.

The sensor chip is mounted to a lead frame made of Cu and plated with Ni/Pd/Au. Chip and lead frame are over molded by green epoxy-based mold compound. Please note that side walls of sensors are diced and hence lead

<sup>15</sup> Temperature range is -40 to 105°C (AEC-Q100 temperature grade 2).

<sup>16</sup> According to accuracy and long term drift specification given on Page 2.

frame at diced edge is not covered with respective protective coating. The total weight of the sensor is 25mg.

**8.2 Filter Cap and Sockets**

For SHT2x a filter cap SF2 will be available. It is designed for fast response times and compact size. Please find the datasheet on Sensirion’s web page.

For testing of SHT2x sensors sockets, such as from Plastronics, part number 10LQ50S13030 are recommended (see e.g. [www.locknest.com](http://www.locknest.com)).

**8.3 Traceability Information**

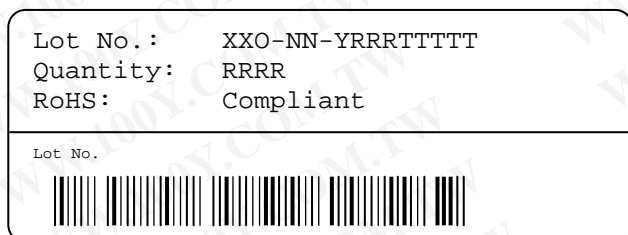
All SHT2x are laser marked with an alphanumeric, five-digit code on the sensor – see Figure 19.

The marking on the sensor consists of two lines with five digits each. The first line denotes the sensor type (SHT21). The first digit of the second line defines the output mode (D = digital, Sensibus and I<sup>2</sup>C, P = PWM, S = SDM). The second digit defines the manufacturing year (0 = 2010, 1 = 2011, etc.). The last three digits represent an alphanumeric tracking code. That code can be decoded by Sensirion only and allows for tracking on batch level through production, calibration and testing – and will be provided upon justified request.

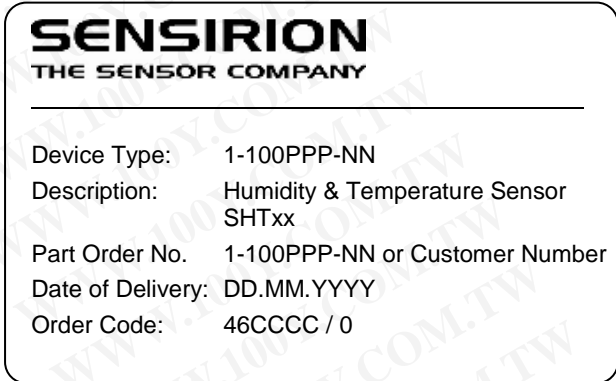


**Figure 19** Laser marking on SHT21. For details see text.

Reels are also labeled, as displayed in Figure 20 and Figure 21, and give additional traceability information.



**Figure 20:** First label on reel: XX = Sensor Type (21 for SHT21), O = Output mode (D = Digital, P = PWM, S = SDM), NN = product revision no., Y = last digit of year, RRR = number of sensors on reel divided by 10 (200 for 2000 units), TTTTT = Traceability Code.

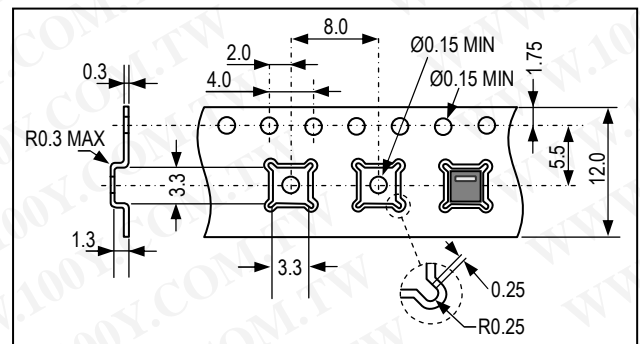


**Figure 21:** Second label on reel: For Device Type and Part Order Number (See Packaging Information on page 2), Delivery Date (also Date Code) is date of packaging of sensors (DD = day, MM = month, YYYY = year), CCCC = Sensirion order number.

**8.4 Shipping Package**

SHT2x are provided in tape & reel shipment packaging, sealed into antistatic ESD bags. Standard packaging sizes are 400, 1500 and 5000 units per reel. For SHT21, each reel contains 440mm (55 pockets) header tape and 200mm (25 pockets) trailer tape.

The drawing of the packaging tapes with sensor orientation is shown in Figure 22. The reels are provided in sealed antistatic bags.



**Figure 22** Sketch of packaging tape and sensor orientation. Header tape is to the right and trailer tape to the left on this sketch.

**9 Compatibility to SHT1x / 7x protocol**

SHT2x sensors may be run by communicating with the Sensirion specific communication protocol used for SHT1x and SHT7x. In case such protocol is applied please refer to the communication chapter of datasheet SHT1x or SHT7x. Please note that reserved status bits of user register must not be changed.

Please understand that with the SHT1x/7x communication protocol only functions described in respective datasheets can be used with the exception of the OTP Reload function that is not set to default on SHT2x. As an

alternative to OTP Reload the soft reset may be used. Please note that even if SHT1x/7x protocol is applied the timing values of Table 5 and Table 7 in this SHT2x datasheet apply.

For the calculation of physical values the following equation must be applied:

For relative humidity  $RH$

$$RH = -6 + 125 \cdot \frac{S_{RH}}{2^{RES}}$$

and for temperature  $T$

$$T = -46.85 + 175.72 \cdot \frac{S_T}{2^{RES}}$$

$RES$  is the chosen respective resolution, e.g. 12 (12bit) for relative humidity and 14 (14bit) for temperature.

## Revision History

| Date            | Version | Page(s)        | Changes  |
|-----------------|---------|----------------|--|
| 6 May 2009      | 0.3     | 1 – 9          | Initial preliminary release  |
| 21 January 2010 | 1.0     | 1 – 4, 7 – 10  | Complete revision. For complete revision list please require respective document.  |
| 5 May 2010      | 1.1     | 1 – 12         | Typical specification for temperature sensor. Elimination of errors. For detailed information, please require complete change list at <a href="mailto:info@sensirion.com">info@sensirion.com</a> .                   |
| 9 May 2011      | 2       | 1 – 7, 10 – 13 | Updated temperature accuracy specifications, MSL and standards. Elimination of errors. For detailed information, please require complete change list at <a href="mailto:info@sensirion.com">info@sensirion.com</a> . |
| December 2011   | 3       | 1, 7-10        | Tolerance of threshold value for low battery signal, minor text adaptations and corrections.   |

## Important Notices

**Do not use this product as safety or emergency stop devices or in any other application where failure of the product could result in personal injury. Do not use this product for applications other than its intended and authorized use. Before installing, handling, using or servicing this product, please consult the data sheet and application notes. Failure to comply with these instructions could result in death or serious injury.**

If the Buyer shall purchase or use SENSIRION products for any unintended or unauthorized application, Buyer shall defend, indemnify and hold harmless SENSIRION and its officers, employees, subsidiaries, affiliates and distributors against all claims, costs, damages and expenses, and reasonable attorney fees arising out of, directly or indirectly, any claim of personal injury or death associated with such unintended or unauthorized use, even if SENSIRION shall be allegedly negligent with respect to the design or the manufacture of the product.

### ESD Precautions

The inherent design of this component causes it to be sensitive to electrostatic discharge (ESD). To prevent ESD-induced damage and/or degradation, take customary and statutory ESD precautions when handling this product.

See application note "ESD, Latchup and EMC" for more information.

### Warranty

SENSIRION warrants solely to the original purchaser of this product for a period of 12 months (one year) from the date of delivery that this product shall be of the quality, material and workmanship defined in SENSIRION's published specifications of the product. Within such period, if proven to be defective, SENSIRION shall repair and/or replace this product, in SENSIRION's discretion, free of charge to the Buyer, provided that:

- notice in writing describing the defects shall be given to SENSIRION within fourteen (14) days after their appearance;

### Warning, Personal Injury

- such defects shall be found, to SENSIRION's reasonable satisfaction, to have arisen from SENSIRION's faulty design, material, or workmanship;
- the defective product shall be returned to SENSIRION's factory at the Buyer's expense; and
- the warranty period for any repaired or replaced product shall be limited to the unexpired portion of the original period.

This warranty does not apply to any equipment which has not been installed and used within the specifications recommended by SENSIRION for the intended and proper use of the equipment. EXCEPT FOR THE WARRANTIES EXPRESSLY SET FORTH HEREIN, SENSIRION MAKES NO WARRANTIES, EITHER EXPRESS OR IMPLIED, WITH RESPECT TO THE PRODUCT. ANY AND ALL WARRANTIES, INCLUDING WITHOUT LIMITATION, WARRANTIES OF MERCHANTABILITY OR FITNESS FOR A PARTICULAR PURPOSE, ARE EXPRESSLY EXCLUDED AND DECLINED.

SENSIRION is only liable for defects of this product arising under the conditions of operation provided for in the data sheet and proper use of the goods. SENSIRION explicitly disclaims all warranties, express or implied, for any period during which the goods are operated or stored not in accordance with the technical specifications.

SENSIRION does not assume any liability arising out of any application or use of any product or circuit and specifically disclaims any and all liability, including without limitation consequential or incidental damages. All operating parameters, including without limitation recommended parameters, must be validated for each customer's applications by customer's technical experts. Recommended parameters can and do vary in different applications.

SENSIRION reserves the right, without further notice, (i) to change the product specifications and/or the information in this document and (ii) to improve reliability, functions and design of this product.

Copyright © 2011, by SENSIRION.  
CMOSens® is a trademark of Sensirion  
All rights reserved

## Headquarters and Subsidiaries

SENSIRION AG  
Laubisruestr. 50  
CH-8712 Staefa ZH  
Switzerland

phone: +41 44 306 40 00  
fax: +41 44 306 40 30  
[info@sensirion.com](mailto:info@sensirion.com)  
[www.sensirion.com](http://www.sensirion.com)

Sensirion AG (Germany)  
phone: +41 44 927 11 66  
[info@sensirion.com](mailto:info@sensirion.com)  
[www.sensirion.com](http://www.sensirion.com)

Sensirion Inc., USA  
phone: +1 805 409 4900  
[info\\_us@sensirion.com](mailto:info_us@sensirion.com)  
[www.sensirion.com](http://www.sensirion.com)

Sensirion Japan Co. Ltd.  
phone: +81 3 3444 4940  
[info@sensirion.co.jp](mailto:info@sensirion.co.jp)  
[www.sensirion.co.jp](http://www.sensirion.co.jp)

Sensirion Korea Co. Ltd.  
phone: +82 31 345 0031 3  
[info@sensirion.co.kr](mailto:info@sensirion.co.kr)  
[www.sensirion.co.kr](http://www.sensirion.co.kr)

Sensirion China Co. Ltd.  
phone: +86 755 8252 1501  
[info@sensirion.com.cn](mailto:info@sensirion.com.cn)  
[www.sensirion.com.cn](http://www.sensirion.com.cn)

To find your local representative, please visit [www.sensirion.com/contact](http://www.sensirion.com/contact)