

634nm 5mW 40°C Reliable Operation

• Features

1. High visibility (634nm)
2. High assembly accuracy
3. High reliability

• Applications

1. Industrial laser markers
2. Measuring instruments
3. Class I, eye-safe laser pointer

• Absolute maximum ratings

Parameter	Symbol	Condition	Rating	Unit
Light output power	P_O	CW	7	mW
Reverse voltage (LD)	V_{RL}	-	2	V
Reverse voltage (PD)	V_{RD}	-	30	V
Forward current (PD)	I_{FD}	-	10	mA
Case temperature	T_C	-	-10~+40	°C
Storage temperature	T_S	-	-40~+85	°C

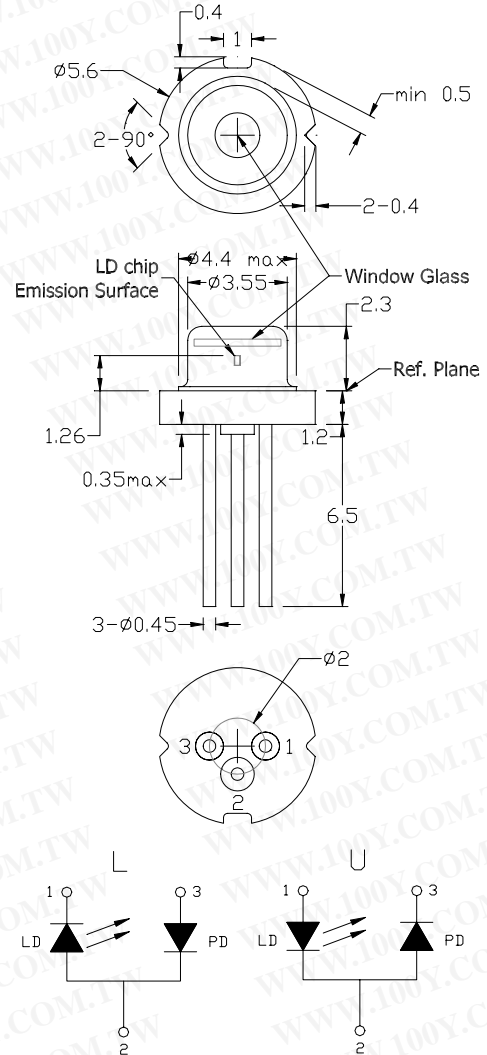

• Electrical and optical characteristics ($T_c=25^\circ\text{C}$)

Parameter	Symbol	Min.	Typ.	Max.	Unit	Conditions
Peak wavelength		630	634	640	nm	$P_o=5\text{mW}$
Threshold current	I_{th}	-	25	30	mA	
Operating current	I_{op}	-	32	40	mA	$P_o=5\text{mW}$
Operating voltage	V_{op}	-	2.2	2.5	V	$P_o=5\text{mW}$
Differential efficiency		0.4	0.6	0.7	mW/mA	$P_o=3\sim 5\text{mW}$
Monitor current	I_m	0.05	0.1	0.3	mA	$P_o=5\text{mW}, V_{RD}=5\text{V}$
Parallel divergence angle	//	6	7.5	11	deg	
Perpendicular divergence angle		30	33	40	deg	
Parallel FFP deviation angle	//	-3	0	+3	deg	$P_o=5\text{mW}$
Perpendicular FFP deviation angle		-3	0	+3	deg	
Emission point accuracy	x y z	-80	0	+80	um	

• Precautions

- * Do not operate the device above maximum ratings. Doing so may cause unexpected and permanent damage to the device.
- * Take precautions to avoid electrostatic discharge and/or momentary power spikes. A change in the characteristics of the laser or premature failure may result.
- * Proper heat sinking of the device assures stability and lifetime. Always ensure that maximum operating temperatures are not exceeded.
- * Observing visible or invisible laser beams with the human eye directly, or indirectly, can cause permanent damage. Use a camera to observe the laser.
- * No laser device should be used in any application or situation where life or property is at risk in event of device failure.
- * Specifications are subject to change without notice. Ensure that you have the latest specification by contacting us prior to purchase or use of the product.

勝特力材料 886-3-5753170
 勝特力电子(上海) 86-21-54151736
 勝特力电子(深圳) 86-755-83298787
[Http://www.100y.com.tw](http://www.100y.com.tw)

AlGaInP Visible Laser Diode

ADL-63052TL/U

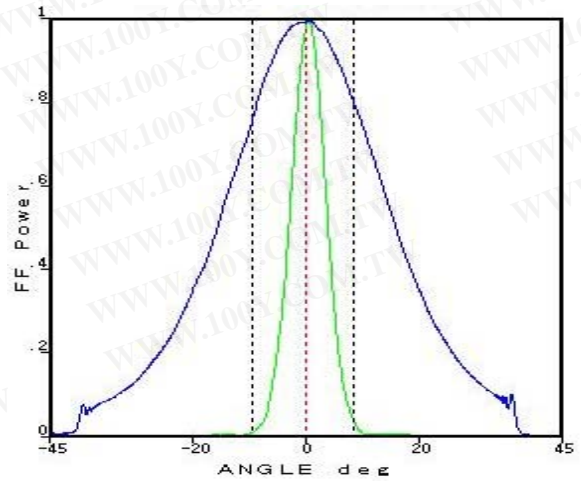
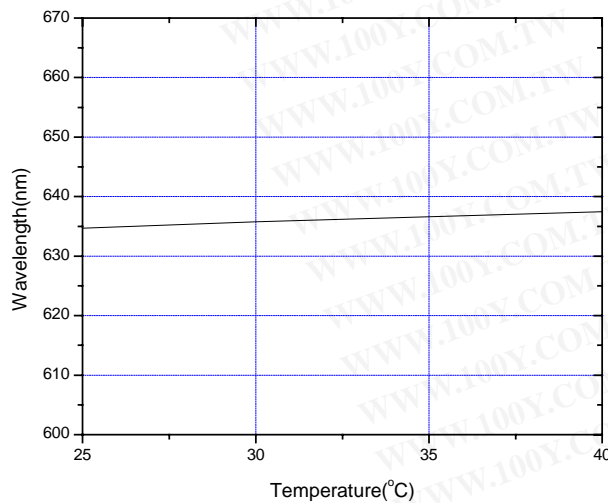
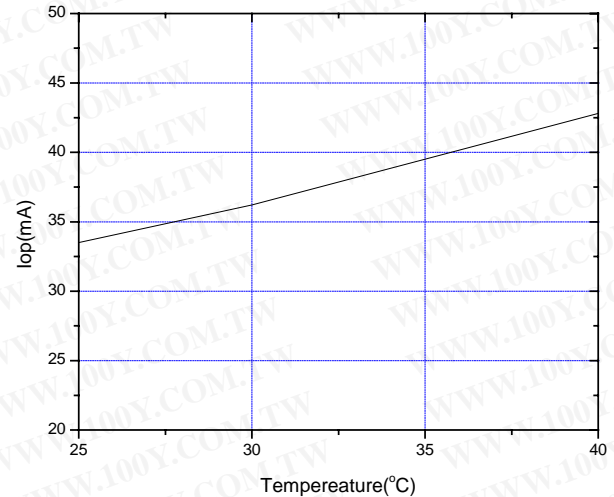
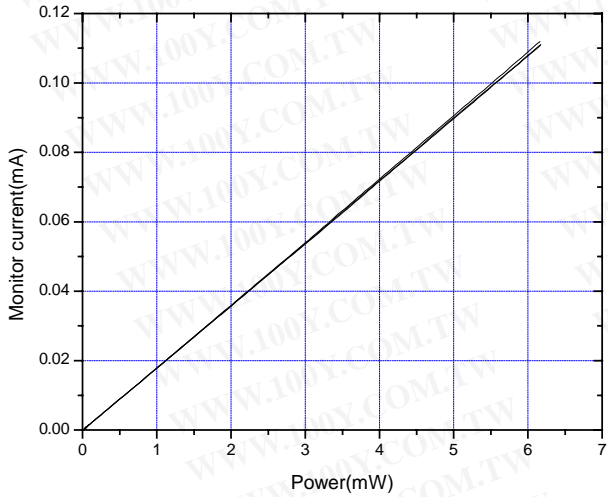
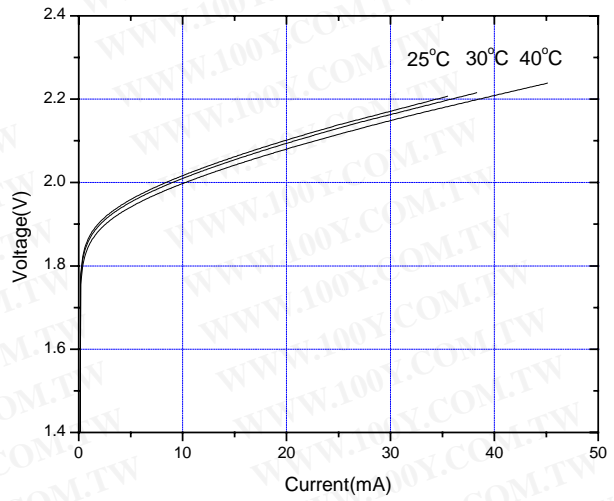
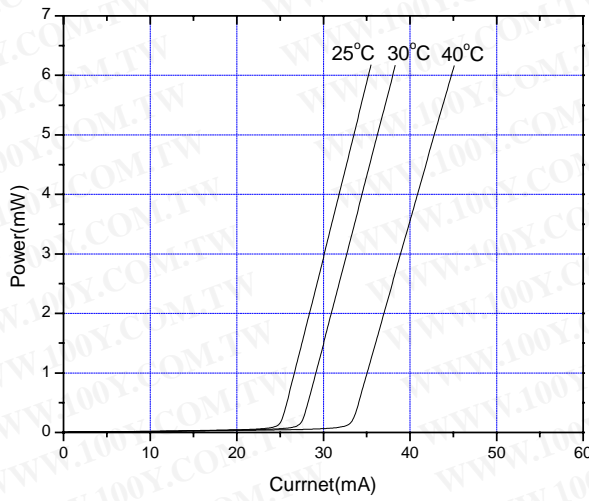

勝特力材料 886-3-5753170
勝特力电子(上海) 86-21-54151736
勝特力电子(深圳) 86-755-83298787
[Http://www.100y.com.tw](http://www.100y.com.tw)